

**Installation Guide**  
**10/100 Fast Ethernet Switch**

## Table of Contents

<b>1. Introduction .....</b>	<b>1</b>
1.1 Features .....	2
1.2 Specifications .....	3
<b>2. Installing the Switch .....</b>	<b>4</b>
2.1 Unpacking .....	4
2.2 Checking AC Power .....	4
2.3 Installing the Switch .....	5
<b>3. Making Network Connections .....</b>	<b>6</b>
3.1 Network Switched Ports .....	6
3.2 UTP Cable .....	7
3.3 Fiber Cable .....	8
3.4 Network Connections .....	9
3.5 Operating Mode .....	10
<b>4. LED Indicators .....</b>	<b>11</b>
4.1 LED Panel .....	11
4.2 Interpretation .....	11

# 1. Introduction

---

Driven by recent advances in desktop computing technology, today's network applications have increased in speed, power and the ability to process information. To meet the demands of these more powerful applications, this affordable switch device provides significant increase in performance for your Ethernet or Fast Ethernet network. This 5-port Fast Ethernet switch comes with four 10/100 TP ports and one fiber port, each capable of transmitting or receiving information simultaneously at full wire speed to control and allocate the network bandwidth.

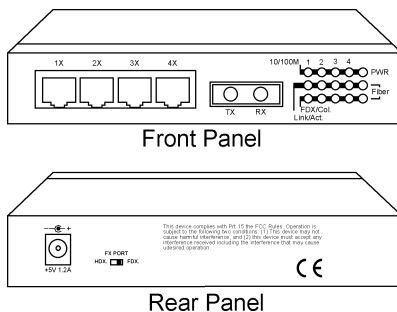

The key features of this switch unit are:

- **Optimized Bandwidth** : Combining five 10/100Mbps-based Fast Ethernet switched ports, the switch delivers a high network bandwidth for your Fast Ethernet network
- **Easy Migration** : With 10BASE-T support on each port, the switch provides a non-disruptive and smooth migration path from Ethernet to a Fast Ethernet network.
- **Fiber Uplink Support** : With 100BASE-FX port, the switch provides a connectivity to a Fast Ethernet network via fiber cable.
- **Easy Installation** : With the functions of auto-speed-sensing and auto-negotiation on each port, the switch supports plug-and-play installation which eliminates configuration problems.

## 1.1 Features

Designed for resolving congestion problems caused by bandwidth-hungry devices and bandwidth-intensive applications as well as a high number of users, the switches not only adhere to the IEEE 802.3 10BASE-T, 802.3u 100BASE-TX and 100BASE-FX standards, but also feature:

- Four 10/100BASE-TX auto-negotiation switched ports and one 100BASE-FX port for flexible connections to desktop PCs, servers and Ethernet hubs.
- The 10/100BASE-TX switched ports support:
  - auto speed sensing for 100Mbps or 10Mbps connection
  - auto configuration with auto-negotiation devices
  - full-duplex or half-duplex operation
- For the fiber port, the switch series support variety of fiber connectors for different application needs. The fiber connectors include ST, SC, MT-RJ, and VF-45 types for multimode and single mode fiber cables.
- Supports duplex mode selector for the 100BASE-FX fiber port.
- Self learning for active MAC addresses
- Store and forward switching to ensure only good packets are forwarded
- Forwarding and filtering at full wire speed
- Supports IEEE 802.3x flow control for full-duplex operation
- Supports back-pressure flow control for half-duplex operation
- Comprehensive LED indicators provide quick, easy to read port and switch information

## 1.2 Specifications

<b>Port 1 - 4</b>	MDI-XRJ-45 jacks for 10/100BASE-TX connectivity
<b>Port 5</b>	One fiber connector for 100BASE-FX connectivity
<b>Cables</b>	10BASE-T Cat. 3, 4, 5 UTP cable (100 meters max.) 100BASE-TX Cat. 5 UTP cable (100 meters max.) 100BASE-FX multimode or single mode fiber cable
<b>LED indicators</b>	Power status 10/100M, Link/Activity, Duplex/Collision status per port
<b>Filtering rate</b>	14,880 pps for Ethernet (10BASE-T) 148,800 pps for Fast Ethernet (100BASE-TX)
<b>Forwarding rate</b>	14,880 pps for Ethernet (10BASE-T) 148,800 pps for Fast Ethernet (100BASE-TX)
<b>Filtering address</b>	Multicast/Broadcast/Unicast address 8K MAC addresses per unit
<b>RAM buffers</b>	256KB
<b>Environment</b>	Temperature 0°C to 40°C Relative humidity 10% to 90% non-condensing
<b>Dimensions</b>	144 mm x 100 mm x 26 mm (WxDxH) 5.67 x 3.94 x 1.02 inch
<b>Power</b>	+5V 1.2A minimum

### Models vs Fiber Specifications

<b>Model</b>	<b>Connector</b>	<b>Fiber Cable</b>	<b>Max. Distance</b>
KS-115F/T	ST	MM <sup>*1</sup>	2 Km
KS-115F/C	SC	MM	2 Km
KS-115F/SA	SC	SM <sup>*2</sup>	15 Km
KS-115F/S3	SC	SM	30 Km
KS-115F/S5	SC	SM	50 Km
KS-115F/JM	MT-RJ	MM	2 Km
KS-115F/JS	MT-RJ	SM	15 Km
KS-115F/VM	VF-45	MM	2 Km
KS-115F/VS	VF-45	SM	15 Km

\*1 : Multimode fiber

\*2 : Single Mode fiber

## 2. Installing the Switch

---

### 2.1 Unpacking

Check to see that you have everything before you start the installation.

- Installation guide
- The switch unit
- One AC power adapter for the unit

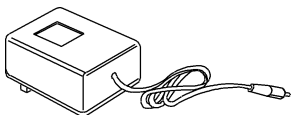

### 2.2 Checking AC Power

Before you begin the installation, check the AC voltage of your area. The AC power adapter which is used to supply the DC power for the unit should have the AC voltage matching the commercial power voltage in your area. The specifications of the AC power adapter are:

- AC input power: AC power voltage of your area
- DC output power: +5V VDC 1.2A min.
- DC plug type: - — (●) — +

The DC power socket for the AC power adapter is located on the rear of the switch as shown below:

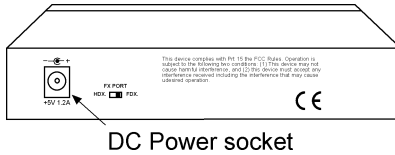

## 2.3 Installing the Switch

1. Install the switch with the AC power adapter provided.

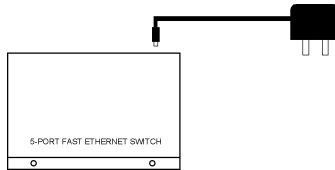

2. Connect the power adapter cable to the switch before connecting the adapter to the AC outlet.

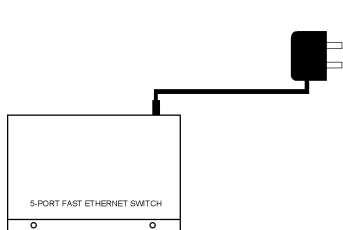

# 3. Making Network Connections

## 3.1 Network Switched Ports

There are five ports on the switch for connection to five LAN segments. Each segment is an independent shared network in one collision-domain.

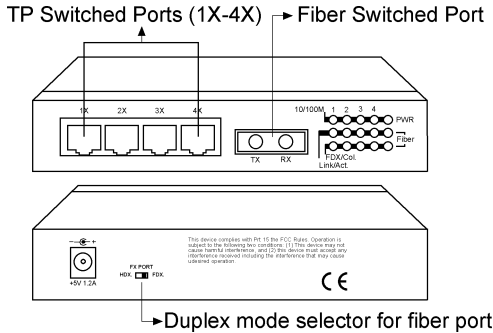

- **Four 10/100BASE-TX switched ports**

Each port consists of one RJ-45 connector and is used for connection to either a 10BASE-T or 100BASE-TX device. The RJ-45 connectors are fixed MDI-X jacks which are designed with internal crossover function. It allows a connection to an end station using straight-through UTP cable.

- **One 100BASE-FX fiber switched port**

This fiber port comes with one fiber connector. For ST and SC connectors, the contact labeled **TX** is used for transmission and the other one labeled **RX** is used for reception. One duplex mode selector is located on the rear panel. Either full duplex or half duplex mode can be selected (factory default: full-duplex).

Setting Position	Duplex Mode
FDX.	Full duplex
HDX.	Half duplex



The following figure illustrates the front panels with different fiber connectors:

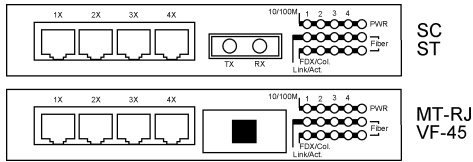

### 3.2 UTP Cable

When making a connection to another device using straight-through UTP cable, make sure MDI-X to MDI connection rule is followed. The following figure illustrates the pin assignments of a straight-through UTP and a crossover UTP cable:

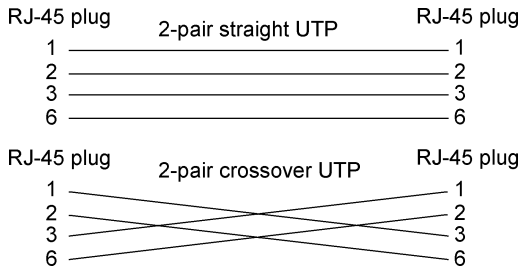

It is suggested to use straight-through UTP cables for all UTP connections. The maximum length and UTP cable categories used for the connections to a 10BASE-T device and 100BASE-TX device are:

CONNECTED DEVICE	UTP CABLE USED & MAXIMUM LENGTH
10BASE-T device	Cat. 3, 4, 5 UTP (100 meters)
100BASE-TX device	Cat. 5 UTP (100 meters)

### 3.3 Fiber Cables

For different fiber connections, several alternative models can be selected for different fiber connections as follows:

Model	Connector	Wavelength	Cable	Max. Distance <sup>*3</sup>
KS-115F/T	ST	1300nm	MM <sup>*1</sup>	2 Km
KS-115F/C	SC	1300nm	MM	2 Km
KS-115F/SA	SC	1300nm	SM <sup>*2</sup>	15 Km
KS-115F/S3	SC	1300nm	SM	30 Km
KS-115F/S5	SC	1300nm	SM	50 Km
KS-115F/JM	MT-RJ	1300nm	MM	2 Km
KS-115F/JS	MT-RJ	1300nm	SM	15 Km
KS-115F/VM	VF-45	1300nm	MM	2 Km
KS-115F/VS	VF-45	1300nm	SM	15 Km

\*1 : Multimode fiber cable

\*2 : Single Mode fiber cable

\*3 : The maximum distance connecting to a full duplex device

The recommended multimode fiber is 62.5/125 $\mu$ m and 9/125 $\mu$ m for single mode fiber.

The following figure illustrates a connection example between two SC fiber ports:

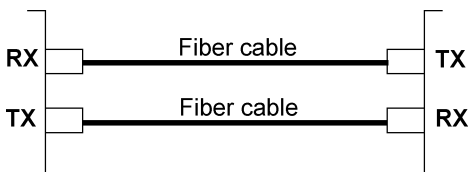

### 3.4 Network Connections

The switch can support connections to the following devices:

- 10BASE-T network cards
- 10/100BASE-TX network cards
- 10BASE-T hub ports
- 100BASE-TX hub ports
- 10/100BASE-TX dual speed hub ports
- 10/100BASE-TX switch ports
- 100BASE-FX switch ports

The following figure illustrates some connection examples and also specifies the maximum distance of each connections:

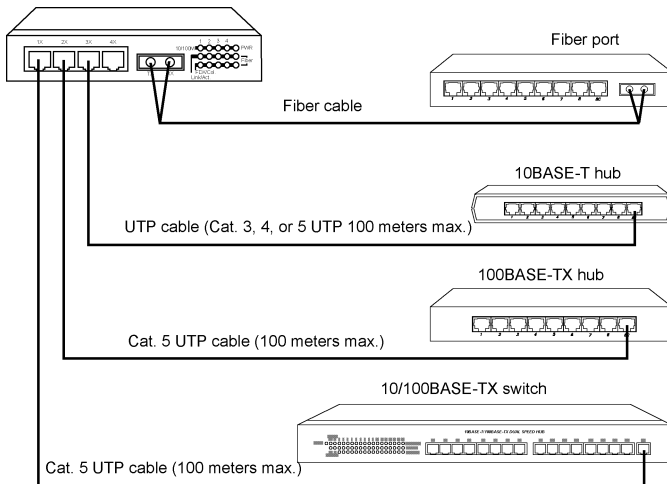

### 3.5 Operating Mode

Four TP ports are designed as auto-negotiation capable switched ports. Each port can determine the speed and duplex type used automatically through an auto-negotiation process with the remote connected auto-negotiation device. The auto-negotiation process is performed when the connection is made. When connecting to a non-auto-negotiation device, each TP port also features the capability to auto-sense the connection speed.

The following table lists the operation mode used for the switched port when it connects to different devices. The operating mode includes the connection speed and duplex type.

<b>Connected Device</b>	<b>Operation Mode Used</b>
10BASE-T hub	10Mbps, half-duplex
100BASE-TX hub	100Mbps, half-duplex
Auto-negotiation device	Auto-negotiation *2
Non-auto*1 half-duplex device	auto-speed-sensing *3, half-duplex
Non-auto full-duplex device	Not supported

\*1 Non-auto : non-auto-negotiation

\*2 determined through auto-negotiation process

\*3 speed is determined by auto-sensing function

Most of 10BASE-T hubs and 100BASE-TX hubs are non-auto-negotiation devices and operate on half-duplex mode.

The operating mode of the fiber port is determined by the setting of duplex mode selector located on rear panel. The following table lists the maximum **MM** fiber cable length connecting to different devices:

<b>Connected Device</b>	<b>Duplex Mode</b>	<b>Distance(MM cable)</b>
Network card	Half-duplex	400 m
Network card	Full-duplex	2 Km
Class I hub	Half-duplex	160 m
2 Class II hubs	Half-duplex	112 m
Switched fiber port	Half-duplex	400 m
Switched fiber port	Full-duplex	2 Km

## 4. LED Indicators

---

### 4.1 LED Panel

The switch provides comprehensive LED indicators for diagnosing and monitoring the operation of the unit as illustrated below:

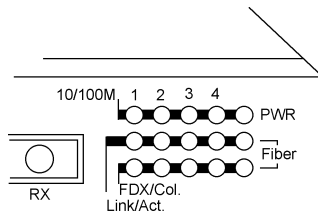

### 4.2 Interpretation

**PWR LED:** indicates the status of the power supplied to the switch.

**10/100M LED:** indicates the connection speed between the TP port and the associated connected device.

**Link/Act. LED:** indicates the link status with a connected device

**FDX/Col. LED:** indicates the duplex mode and collision occurrences

The following table lists the LED states and the indications:

LED	STATE	INDICATION
Power	Off	No power is supplied to the device.
Power	On	Power is supplied to the device.
10/100	Off	10Mbps is used.
10/100	On	100Mbps is used.
Link/Act.	Off	No active cable link
Link/Act.	On	An active link is established.
Link/Act.	Blink	Tx/Rx activities
FDX/Col	On	Full duplex is used.
FDX/Col	Off	Half duplex is used.
FDX/Col	Blink	Half duplex and collision occurrences