



KPW-T2P25

Industrial IEEE 802.3at High Power PoE Splitter

User's Manual



DOC.180327A

(C) 2018 KTI Networks Inc. All rights reserved. No part of this documentation may be reproduced in any form or by any means or used to make any derivative work (such as translation or transformation) without permission from KTI Networks Inc.

KTI Networks Inc. reserves the right to revise this documentation and to make changes in content from time to time without obligation on the part of KTI Networks Inc. to provide notification of such revision or change.

For more information, contact:

United States KTI Networks Inc.
P.O. BOX 631008
Houston, Texas 77263-1008

Phone: 713-2663891
Fax: 713-2663893
E-mail: kti@ktinet.com
URL: <http://www.ktinet.com/>

International Fax: 886-2-26983873
E-mail: kti@ktinet.com.tw
URL: <http://www.ktinet.com.tw/>

The information contained in this document is subject to change without prior notice. Copyright (C) All Rights Reserved.

TRADEMARKS

Ethernet is a registered trademark of Xerox Corp.

FCC NOTICE

This device complies with Class A Part 15 the FCC Rules. Operation is subject to the following two conditions:

(1) This device may not cause harmful interference, and (2) this device must accept any interference received including the interference that may cause.

CE NOTICE

Marking by the symbol indicates compliance of this equipment to the EMC directive of the European Community. Such marking is indicative that this equipment meets or exceeds the following technical standards:

EMC Class A

EN55022:2006/A1:2007 Class A

EN61000-3-2:2006

EN61000-3-3:2008

EN 55024:1998/A1:2001/A2:2003

IEC 61000-4-2:2009

IEC 61000-4-3:2006/A1:2008

IEC 61000-4-4:2004

IEC 61000-4-5:2006

IEC 61000-4-6:2009

IEC 61000-4-8:1993/A1:2001

IEC 61000-4-11:2004

VCCI

この装置は、クラスA情報技術装置です。この装置を家庭環境で使用すると電波妨害を引き起こすことがあります。この場合には使用者が適切な対策を講ずるよう要求されることがあります。

VCCI-A

Table of Contents

Introduction.....	5
Features.....	6
Specifications	6
Function Diagram	8
Safety Cautions	8
Application Notes	9
Application Example	13

Introduction

KTI Network's KPW-T2P25 is a high power PoE splitter which integrates Power over Ethernet (PoE) technology to PoE incapable network device by just using a single Cat.5 cable for both power and data transaction. The equipments such as Wireless Router, AP, Network Camera, Print server, and Media converter which connect to the PoE splitter, all devices become PoE enabled to eliminate the need of power outlets as well as cable installation and expense.

The splitter is equipped with DIP SW that allows user to select one from five different classes for demanding power from a remote PoE switched port or mid-span injector. This feature supports efficient power management at the advanced PSE side. It supports Type 1 for power up to 13 Watts min. and Type 2 for power up to 30 Watts. For industrial applications, the splitter is also equipped with optional brackets for Din-Rail mounting and panel mounting. To enhance application safety, the splitter is featured short-circuit protection, low voltage lock out, inrush current limit and thermal protection.



Four optional models with different DC output voltages, 5V/9V/12V are available for purchasing to meet different appliance power specification. For easier, cost-effective PoE network installation, the PoE splitter is your best solution to protect original investment.

Features

- Enable PoE incapable network device with PoE capability
- IEEE 802.3at and 802.3af compliance
- Support 10BASE-T, 100BASE-TX, and 1000BASE-T
- Support Alternative A or Alternative B PoE input over Cat.5
- Provide a power class selection DIP for demanding power from PSE
- Support Type 1 PSE classification and Type 2 PSE 2-event classification
- Regulated DC power output with four optional voltages
- Flexible mounting support, light weight and compact

Specifications

Standard	IEEE 802.3 10BASE-T, 100BASE-TX, 1000BASE-T
PoE In Jack	Shielded RJ-45

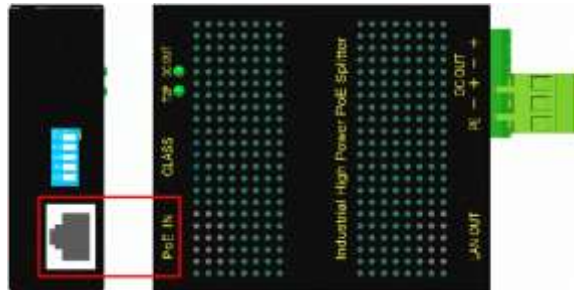

10BASE-T, 100BASE-TX, 1000BASE-T support
 Power pins – Pin1/2/3/6 and Pin4/5/7/8 (support both)
 LAN cable - Cat.5 or better

PoE Standard	IEEE 802.3af Type 1, IEEE 802.3at Type 2
PoE Input Voltage	36 ~ 57VDC (Delivery from Type 1 PSE) 42.5 ~ 57VDC (Delivery from Type 2 PSE) *These ranges mean the possible maximal power received by the splitter. The input power depends on the power capability delivered by PSE and the loss caused by the cable connection length between the PSE and the splitter.
PoE Power Class	Type 1 Class 0 ~ Class 3, Type 2 Class 4 (DIP SW selectable)

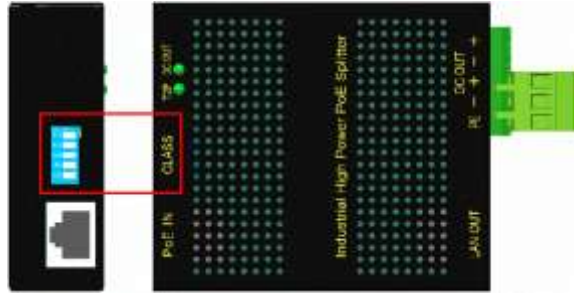

LAN Out Jack

Shielded RJ-45

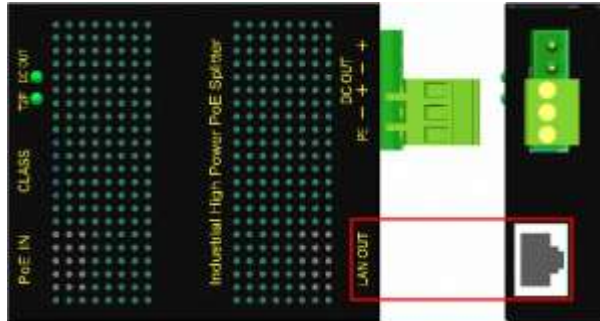

10BASE-T, 100BASE-TX, 1000BASE-T support

LAN cable - Cat.5 or better

DC Power Output

5P Terminal block – PE (protective earth), DC+/DC-, DC+/DC-

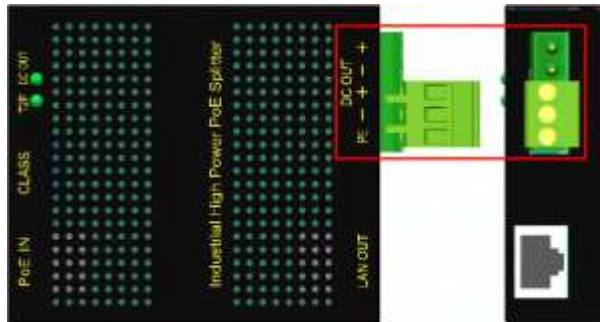

Voltage options: 5V, 9V, 12V (±5%) (Model options)

Power wire: 12 ~ 22AWG

PSE Type	PoE Input Range * ¹ (W)	DC Power Output max. * ² (W)
1	12.95 ~ 15.4	9 min.
2	25.5 ~ 34	18 min. (5V) 20 min. (9V, 12V)

*¹ The range means the possible maximum power received by the splitter. It depends on the power capability delivered by PSE and the connection length between the PSE and splitter.

*² The amount of DC output power is less than the PoE power received on the IN Jack due to conversion efficiency.

LED Display	Type 2 PoE input status, DC Power output status
Housing	Enclosed metal with no fan
Dimension	85 x 73 x 24 mm (LxWxH)
Accessory	TB-to-DC plug cable
Mounting Support	DIN-Rail, Panel mounting (Optional)
Temperature	Operating Temperature: -30°C ~ +70°C Storage Temperature: -30°C ~ +85°C Relative Humidity: 10% ~ 90% non-condensing
Approval	FCC Part 15 Class A, CE Mark Class A, VCCI Class A, IEC60950-1 safety

Function Diagram

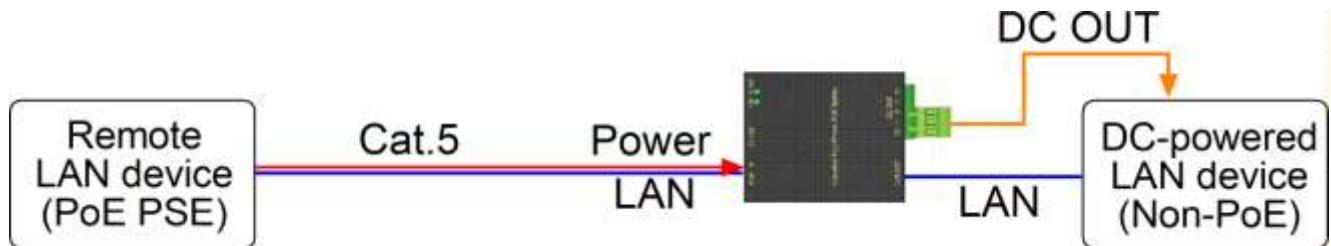

Remote LAN device: This PoE PSE delivers LAN signal and PoE power via single Cat.5. It can be mid-span PoE injector or end-point PoE switch.

KPW-T2P25:

1. Split the reception on Cat.5 into LAN signal and Power.
2. Convert PoE power to low voltage DC power for a local LAN device with no PoE capability.

Local LAN device: A local LAN device which has no PoE capability. It is powered by the KPW-T2P25. The devices can be IP cameras or LAN-based industrial controllers.

Safety Cautions

To reduce the risk of bodily injury, electrical shock, fire and damage to the product, observe the following precautions.

- ✓ Do not service any product except as explained in your system documentation.
- ✓ Opening or removing covers may expose you to electrical shock.
- ✓ Only a trained service technician should service components inside these compartments.
- ✓ If any of the following conditions occur, unplug the product from the electrical outlet and replace the part

or contact your trained service provider:

- The power cable, extension cable, or plug is damaged.
 - An object has fallen into the product.
 - The product has been exposed to water.
 - The product has been dropped or damaged.
 - The product does not operate correctly when you follow the operating instructions.
- ✓ Do not push any objects into the openings of your system. Doing so can cause fire or electric shock by shorting out interior components.

Application Notes

Power Class Selection (SW)

SW1	SW2	SW3	SW4	SW5	Type: Class	Power Request
ON	OFF	OFF	OFF	OFF	Type 1: Class 0	12.95 W min.
ON	ON	OFF	OFF	OFF	Type 1: Class 1	3.84 W
ON	OFF	ON	OFF	OFF	Type 1: Class 2	3.84 - 6.49 W
ON	OFF	OFF	ON	OFF	Type 1: Class 3	6.49 – 12.95 W
OFF	OFF	OFF	OFF	ON	Type 2: Class 4	25.5 W min.

This power class selection makes PD power notification to the remote PSE for PD discovery, power classification operation. It does not cause any power consumption limitation on the splitter itself.

Note that some PSE devices use the class notification for PoE power management and may limit the power delivery according to the received class notification.

Model Options

Part Number	Model	DC Output voltage	DC power wire*
KPW-T2P25-5V	5V	+5VDC	12 ~ 16 AWG
KPW-T2P25-9V	9V	+9VDC	12 ~ 22 AWG
KPW-T2P25-12V	12V	+12VDC	12 ~ 22 AWG

*Solid or stranded wire, 1m max.

Optional Accessories

Part Number	Description
KC-4DR	DIN-Rail mounting bracket
PMB-303	Panel mounting bracket

Conversion of PoE IN to DC OUT

The efficiencies of the conversion from PoE input to four different DC output are shown as the following figures. Each figure has two curves. One is when PoE input voltage is 55V and the other is 48V.

Note:

- 1. The PoE input means the power received just right on the RJ-45 connector of the product.*
- 2. The DC output means the power output just on the DC terminal block connector.*
- 3. For a real application, the Cat.5 cable for connecting PoE PSE end to the product may cause power loss of about 2 ~ 4 watts with length 100 meters. The loss depends on the cable quality.*
- 4. +55VDC & 48VDC are given in the following figures as two examples of PoE input voltage.*

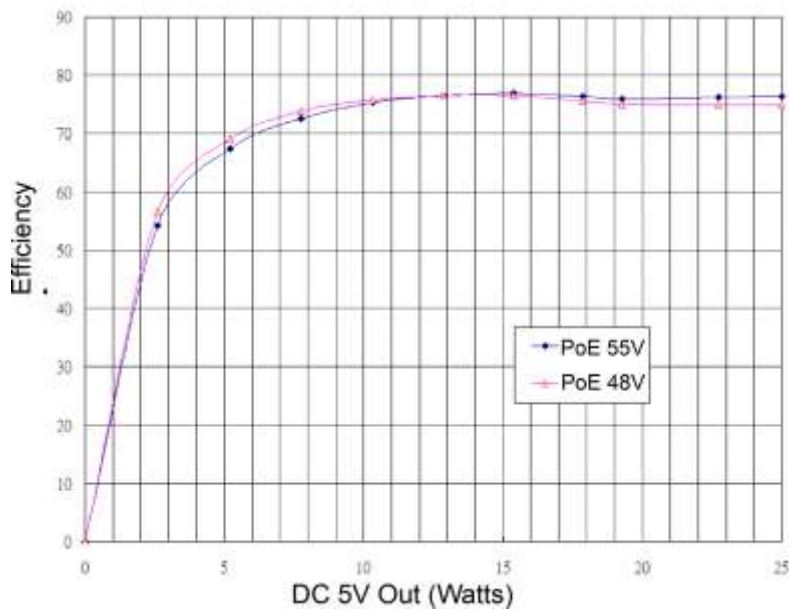

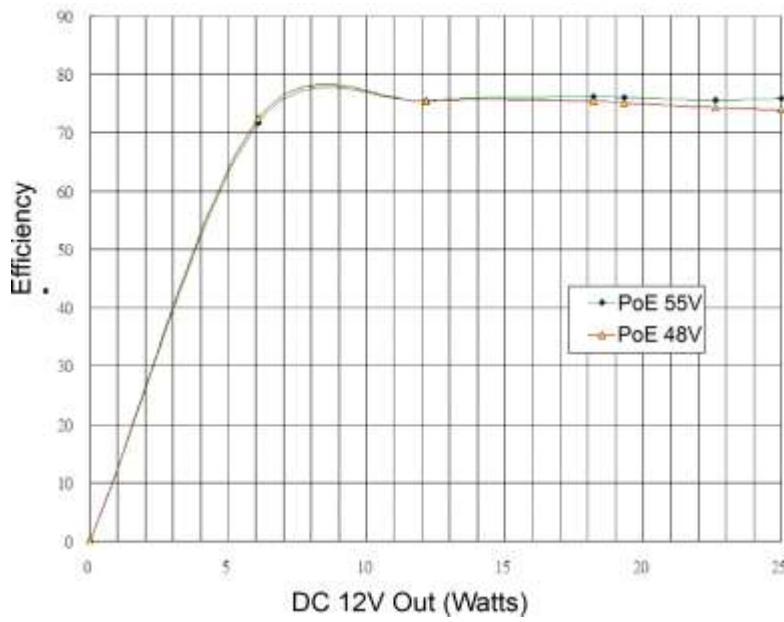
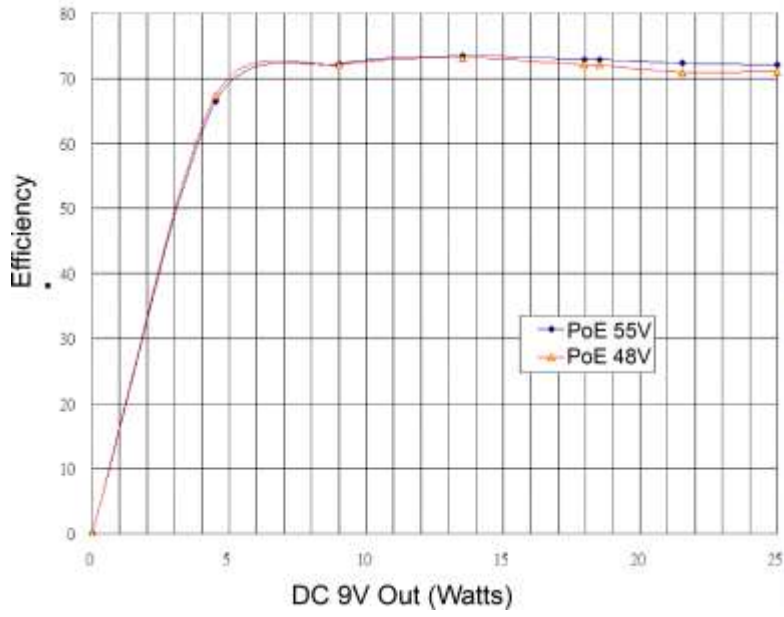

DIN-Rail Mounting

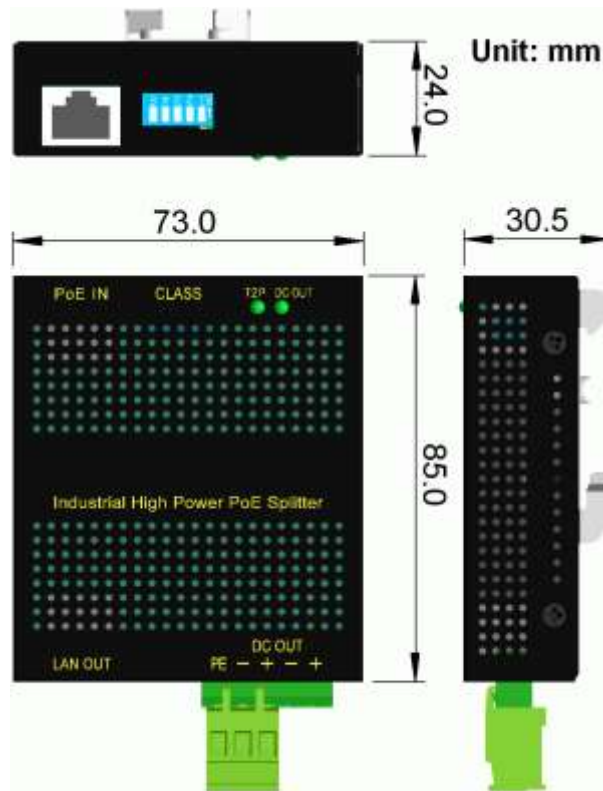

Panel Mounting

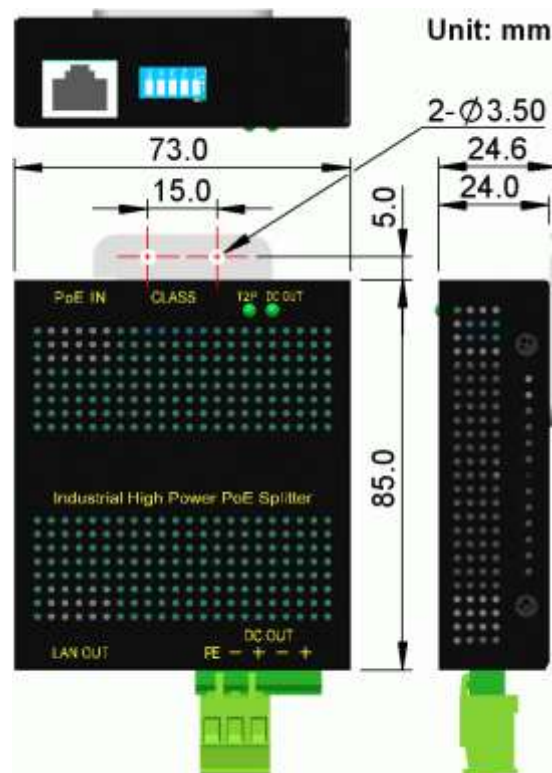

Application Example

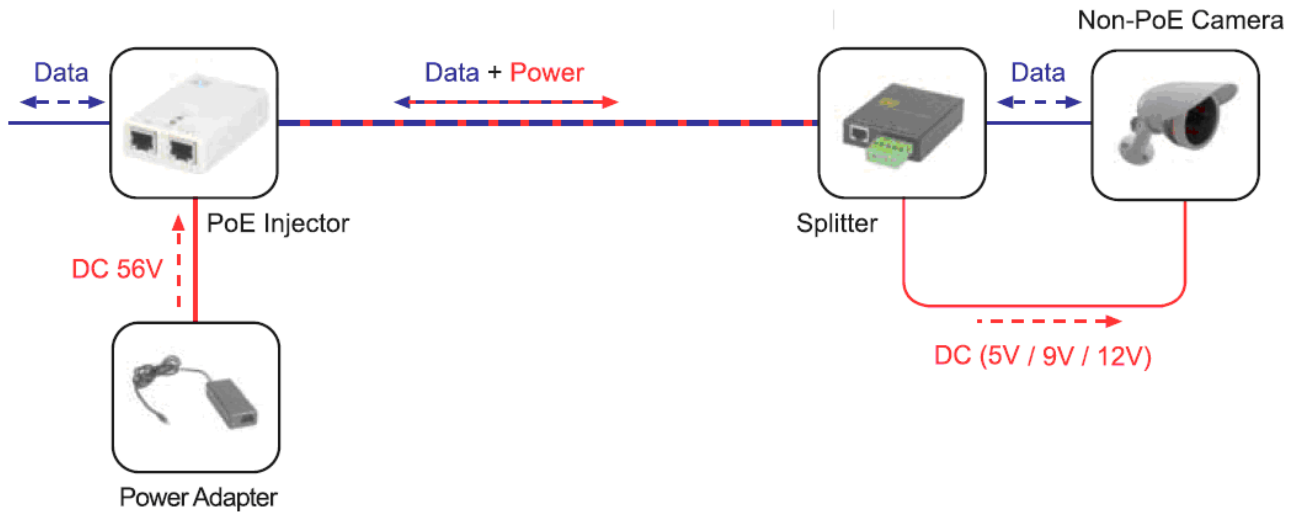

KPOE-100P

KTI High power mid-span PoE+ injector as remote PoE PSE

Local LAN device

PoE incapable IP camera