



**netsys**

*Networking your world*

**NV-600AI**

**Industrial ADSL2+/VDSL2 Router**

**USER'S MANUAL**

[Http://www.netsys.com.tw](http://www.netsys.com.tw)



## Copyright

Copyright © 2012 by National Enhance Technology Corp. All rights reserved.

## Trademarks

NETSYS is a trademark of National Enhance Technology Corp.

Other brand and product names are registered trademarks or trademarks of their respective holders.

## Legal Disclaimer

The information given in this document shall in no event be regarded as a guarantee of conditions or characteristics. With respect to any examples or hints given herein, any typical values stated herein and/or any information regarding the application of the device, National Enhance Technology Corp. hereby disclaims any and all warranties and liabilities of any kind, including without limitation warranties of non-infringement of intellectual property rights of any third party.

## Statement of Conditions

In the interest of improving internal design, operational function, and/or reliability, NETSYS reserves the right to make changes to the products described in this document without notice. NETSYS does not assume any liability that may occur due to the use or application of the product(s) or circuit layout(s) described herein.

Maximum signal rate derived from IEEE Standard specifications. Actual data throughput will vary. Network conditions and environmental factors, including volume of network traffic, building materials and construction, and network overhead, lower actual data throughput rate. Netsys does not warrant that the hardware will work properly in all environments and applications, and makes no warranty and representation, either implied or expressed, with respect to the quality, performance, merchantability, or fitness for a particular purpose. Make sure you follow in line with the environmental conditions to use this product.

## Foreword: Industrial-grade VDSL2 CPE Router solution

### Attention:

**Be sure to read this manual carefully before using this product. Especially Legal Disclaimer, Statement of Conditions and Safety Warnings.**

Netsys' NV-600AI is an industrial VDSL2 CPE router with enhanced management that leverages the extraordinary bandwidth promise of VDSL2 (max. 100Mbps Symmetric) technology, the next step in the delivery of new high-speed Internet applications in industrial environments. In addition to using a DIN-Rail design that is quick, easy and economical to install and maintain, it offers high-performance broadband/multimedia services to industrial environments such as Factories, MRT, Train stations, Ticket vending machines, Parking systems, Monitoring systems and point to point applications. NV-600AI is a CPE (Customer Premise Equipment) device.

Netsys NV600AI is seen by many operators as an ideal accompaniment to a FTTP rollout, where for instance fiber optic is supplied direct to an apartment block and from there copper cable is used to supply residents with high-speed VDSL2.

### Caution:

The NV-600AI is industrial-grade applications. This product does not have waterproof protection.

## Safety Warnings

For your safety, be sure to read and follow all warning notices and instructions before using the device.

- ◆ **DO NOT** open the device or unit. Opening or removing the cover may expose you to dangerous high voltage points or other risks. ONLY qualified service personnel can service the device. Please contact your vendor for further information.
- ◆ **Use ONLY** the dedicated power supply for your device. Connect the power to the right supply voltage (110V AC used for North America and 230V AC used for Europe. NV-600AI supports 12 to 48 VDC dual power input(Redundant power)).
- ◆ **Place** connecting cables carefully so that no one will step on them or stumble over them. DO NOT allow anything to rest on the power cord and do NOT locate the product where anyone can work on the power cord.
- ◆ **DO NOT** install nor use your device during a thunderstorm. There may be a remote risk of electric shock from lightning.
- ◆ **DO NOT** expose your device to dampness, dust or corrosive liquids.
- ◆ **DO NOT** use this product near water, for example, in a wet basement or near a swimming pool.
- ◆ **Connect ONLY** suitable accessories to the device.
- ◆ **Make sure** to connect the cables to the correct ports.
- ◆ **DO NOT** obstruct the device ventilation slots, as insufficient air flow may harm your device.
- ◆ **DO NOT** place items on the device.
- ◆ **DO NOT** use the device for outdoor applications directly, and make sure all the connections are indoors or have waterproof protection place.
- ◆ **Be careful** when unplugging the power, because it may produce sparks.
- ◆ **Keep** the device and all its parts and accessories out of the reach of children.
- ◆ **Clean** the device using a soft and dry cloth rather than liquid or atomizers. Power off the equipment before cleaning it.
- ◆ This product is **recyclable**. Dispose of it properly.

## TABLE OF CONTENTS

COPYRIGHT .....	1
FOREWORD: INDUSTRIAL-GRADE VDSL2 CPE ROUTER SOLUTION .....	2
<b>SAFETY WARNINGS</b> .....	3
1.1 Check List .....	10
<b>CHAPTER 2. INSTALLING THE ROUTER</b> .....	11
2.1 Hardware Installation.....	11
2.2 Pre-installation Requirements .....	11
2.3 General Rules .....	12
2.4 Connecting the Router .....	13
2.5 Connecting the RJ-11 / RJ-45 Ports .....	14
<b>2.6 Terminal Block and DIN-Rail mount installation</b> .....	16
<b>2.7 Industrial VDSL2 Application</b> .....	17

<b>CHAPTER 3. HARDWARE DESCRIPTION</b> .....	20
3.1 Front Panel.....	21
3.2 Front Indicators .....	21
<b>3.3 Rear Panel</b> .....	23
<b>3.4 Side Panel</b> .....	23
<b>CHAPTER 4. CONFIGURE THE NV-600AI VIA WEB BROWSER</b> .....	28
<b>4.1 Login</b> .....	29
<b>4.1.1 Home</b> .....	30
<b>4.1.2 Quick Setup</b> .....	32
<b>4.2 Select the Menu Level</b> .....	38
<b>4.3 Select “SYSTEM”</b> .....	39
4.3.1 Host Name Config .....	40
4.3.2 System Time .....	41
4.3.3 Administrator Settings .....	43
<b>4.3.4 Web Settings</b> .....	45
<b>4.3.5 Software/Firmware Upgrade</b> .....	46
<b>4.3.6 Configuration Settings</b> .....	47
<b>4.3.7 System Log</b> .....	50



4.3.8 SSL Certificate .....	53
4.3.9 Mac Table Aging Time .....	54
4.3.10 Vlan Tag Pass Through Mode Setting.....	55
4.3.11 Reset .....	56
4.4 Select “Statistics” .....	57
4.4.1 LAN .....	58
4.4.2 WAN .....	60
4.5 Select “xDSL” .....	62
4.5.1 xDSL Status .....	63
4.5.2 Vectoring Mode selection.....	65
About vectoring function(Reference only): .....	66
4.6 Select “WAN” .....	67
4.6.1 WAN Mode Selection .....	68
4.6.2 Auto Detect Setting .....	70
4.6.3 WAN Channel Config.....	73
4.6.4 VLAN Channel confg .....	77
4.6.5 WAN Setting .....	80
4.6.6 WAN Status.....	94
4.6.7 DNS .....	98
4.6.8 DDNS .....	100
4.6.9 OAM Configuration .....	102



<b>4.7 Select “LAN”</b> .....	106
<b>4.7.1 LAN ARP List</b> .....	107
<b>4.7.2 LAN Settings</b> .....	108
<b>4.7.3 UPnP Devices List</b> .....	118
<b>4.7.4 LAN Switch Port Setting</b> .....	120
<b>4.7.5 LAN Port Status</b> .....	121
<b>4.8 Select “Route”</b> .....	125
<b>4.8.1 Static Routing</b> .....	126
<b>4.8.2 RIP Support</b> .....	129
<b>4.8.3 Routing Table List</b> .....	132
<b>4.9 Select “Firewall”</b> .....	135
<b>4.9.1 Firewall Setting</b> .....	136
<b>4.9.2 IPv6 Firewall Setting</b> .....	137
<b>4.9.3 Packet Filtering</b> .....	139
<b>4.9.4 URL Filtering</b> .....	153
<b>4.9.5 Parental Control</b> .....	155
<b>4.9.6 Application Server Settings</b> .....	157
<b>4.9.7 Access Control List (ACL)</b> .....	159
<b>4.10 NAT</b> .....	161
<b>4.10.1 NAT Settings</b> .....	162
<b>4.10.2 Virtual Server</b> .....	163
<b>4.10.3 Port Triggering</b> .....	167



4.10.4 DMZ .....	171
4.11 QoS .....	173
4.11.1 QoS Settings .....	174
4.11.2 Queue Config .....	176
4.11.3 Class Config .....	180
4.12 Multicast .....	186
4.12.1 Proxy Settings .....	187
4.12.2 Snooping Settings .....	189
4.12.3 Advanced Settings .....	190
4.13 IPsec .....	192
4.13.1 Tunnel Mode .....	192
4.14 IPv6 .....	195
4.14.1 IPv6 Setting .....	196
4.14.2 6RD Configuration .....	198
4.14.3 DS-Lite Configuration .....	200
4.15 Diagnostics .....	202
4.15.1 Diagnostic Test Suite .....	203
4.16 SNMP .....	205
4.16.1 SNMP Options .....	206
4.16.2 SNMPv3 Settings .....	208



4.16.3 Add v3 user .....	209
<b>APPENDIX A:</b> CABLE REQUIREMENTS .....	211
<b>APPENDIX B:</b> PRODUCT SPECIFICATION .....	214
<b>APPENDIX C:</b> ROUTER/BRIDGED MODE SELECT .....	218
<b>APPENDIX D:</b> NV-600LI/NV-600AI COMPATIBILITY TABLE .....	223
<b>APPENDIX E:</b> IP-30 PROTECTION OF METAL CASE .....	225
<b>APPENDIX F:</b> TROUBLESHOOTING .....	227
<b>APPENDIX G:</b> COMPLIANCE INFORMATION .....	235
WARRANTY .....	238
<b>CHINESE SJ/T 11364-2014</b> .....	239

## Chapter 1. Unpacking Information

### 1.1 Check List

Thank you for choosing Netsys NV-600AI. Before installing the router, please verify the contents inside the package.

#### Package Contents:

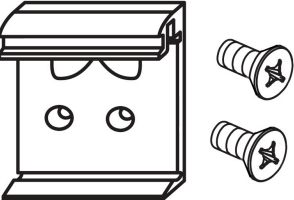
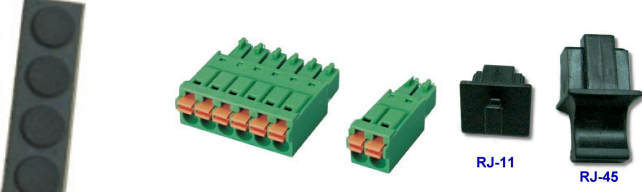
			
<p>1 x Industrial VDSL2 CPE router</p>	<p>1 x QR code for user's manual hyperlink.</p>	<p><b>Accessory Kit :</b> 1 x DIN-Rail mounting plate, 2 x screws, 4 x Feet, Protective caps (RJ-11*1, RJ-45*3), 1 x 6pin Terminal Block, 1 x 2pin Terminal Block</p>	

#### Notes:

1. Please inform your dealer immediately for any missing or damaged parts. If possible, retain the carton including the original packing materials. Use them to repack the unit in case there is a need to return for repair.
2. If the product has any issue, please contact your local distributor.
3. Please use the provided protective caps for unused ports.
4. Please look for the QR code on the bottom of the product, the user can launch the QR code scanning program to scan and download the user's manual electronic format file. Above QR code icon is for reference.
5. Power Input: This model supports 12~48V DC power adapters with recommended 17 Watts or above.

## Chapter 2. Installing the Router

**Caution:**

**Please equip the anti-static devices during INSTALLATION.**

### 2.1 Hardware Installation

This chapter describes how to install the router and establish the network connections. The NV-600AI may be installed on any level surface (e.g. a table or DIN RAIL). However, please take note of the following minimum site requirements before you begin.

### 2.2 Pre-installation Requirements

Before you start the actual hardware installation, make sure you can provide the right operating environment, including power requirements, sufficient physical space, and proximity to other network devices that are to be connected.

Verify the following installation requirements:

- Power requirements: **DC 12 to 48VDC redundant power.**
- The router should be located in a cool dry place, with at least **10cm/4in** of space at the front and back for ventilation.
- Place the router away from direct sunlight, heat sources, or areas with a high amount of electromagnetic

interference.

- Check if the network cables and connectors needed for installation are available.
- **Do Not install phone lines strapped together with AC power lines, or telephone office line with voice signal.**
- **Avoid installing this device with radio amplifying stations nearby or transformer stations nearby.**

### **2.3 General Rules**

Before making any connections to the router, please note the following rules:

- **Ethernet Port (RJ-45)**

All network connections to the router Ethernet port must be made using Category 5 UTP/STP or above for 100 Mbps, Category 3, 4 UTP for 10Mbps.

No more than 100 meters of cabling may be use between the MUX or HUB and an end node.

- **VDSL2 Port (RJ-11)**

All network connections to the RJ-11port must use **24~26** gauge with **twisted pair** phone wiring.

We **do not recommend** the use of the telephone line 28 gauge or above.

The RJ-11 connectors have six positions, two of which are wired. The router uses the center two pins. The pin out assignment for these connectors is presented below.

Please note that the line port is no polarity, therefore user can reverse the two wires of the phone cable when installed.

RJ-11 Pin out Assignments

Pin#	MNEMONIC	FUNCTION
1	NC	Unused

2	NC	Unused
<b>3</b>	<b>DSL</b>	<b>Used</b>
<b>4</b>	<b>DSL</b>	<b>Used</b>
5	NC	Unused
6	NC	Unused_

## **2.4 Connecting the Router**

The router has four Ethernet port which support connection to Ethernet operation. The devices attached to these ports must support auto-negotiation /10Base-T / 100Base-TX / 1000Base-TX unless they will always operate at half duplex. Use any of the Ethernet ports to connect to devices such as Monitor system, Server, Switch, bridge or router.

### **Notes:**

1. The (RJ11/Terminal Block) Line port is used to connect the telephone that is connected to VDSL2 CO and CPE router (Point-to-point solution).
2. Use the provided protective caps for unused ports to avoid dust intrusion.
3. The Slave device (CPE) must be connected to the Master device (CO) through the telephone wire. The Slave cannot be connected to another Slave, and the Master cannot be connected to another Master.

**2.5 Connecting the RJ-11 / RJ-45 Ports**

- ◆ The line port has 2 connectors: RJ-11 and terminal block. It is used to connect with NV-600LI(CO) using a single pair phone cable to NV-600AI(CPE) bridge side (point to point solution). Take note that NV-600AI line port cannot be used at the same time. Either RJ-11 port is connected or terminal block is connected using a straight connection (Figure 2.5.1) or cross-over connection(Figure 2.5.2)

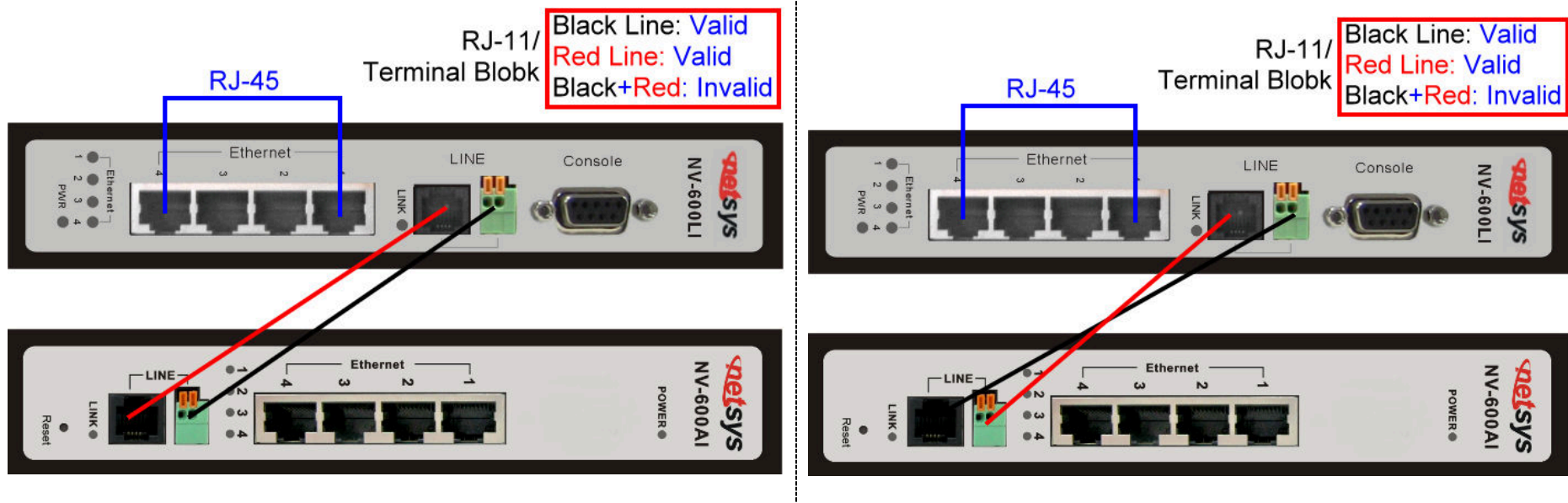

**Figure 2.5.1 NV-600LI/AI line ports straight connection**

**Figure 2.5.2 NV-600LI/AI line ports straight connection**

- ◆ When inserting a RJ-11 plug, make sure the tab on the plug clicks into position to ensure that it is properly seated.
- ◆ **Do not** plug a RJ-11 phone jack connector into the Ethernet port (RJ-45 port). This may damage the router. Instead, use only twisted-pair cables with RJ-45 connectors that conform to Ethernet standard.

**Notes:**

1. Be sure each twisted-pair cable (RJ-45 Ethernet cable) does not exceed 100 meters (333 feet).
2. We advise using Category 5~7 UTP/STP cables for making Bridge or Router connections to avoid any confusion or inconvenience in the future when you attach high bandwidth devices.
3. Use **24 ~ 26** gauge twisted pair phone wiring, we do not recommend 28 gauge or above.
4. Be sure phone wire has been installed before NV-600AI boot.



## **2.6 Terminal Block and DIN-Rail mount installation**

This section describes how to install the Terminal Block and DIN-Rail to the router, if you do not install the DIN-Rail, please paste the 4 rubber feet at the bottom of the hulled to avoid scratches of metal housing.

- ◆ Take out the “2pin / 6pin terminal block” from inside the accessory kit, and install to the router properly. (Figure 2.6.1)
- ◆ Please refer to install the DIN-RAIL as following step:
  1. Install the DIN-Rail mounting plate to the NV-600AI. (Figure 2.6.2)
  2. Please use the suitable DIN-Rail to install, please refer to the dimensions of the DIN-Rail.(Figure 2.6.3)
  3. Insert the top of the DIN-Rail into the top slots on the DIN-Rail mounting plate and the DIN-Rail mounting plate will snap into place. (Figure 2.6.4)

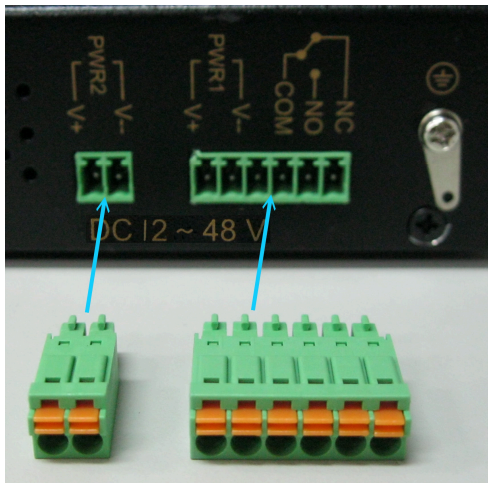

**Figure 2.6.1**

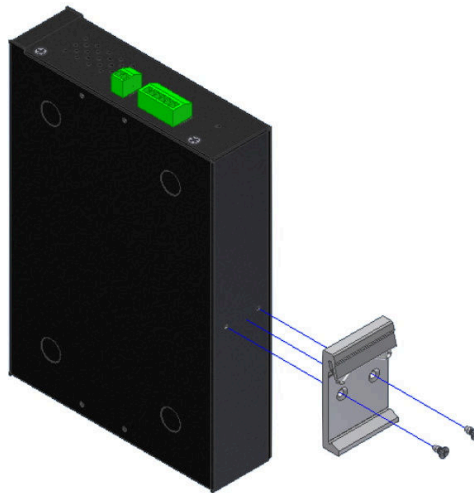

**Figure 2.6.2**

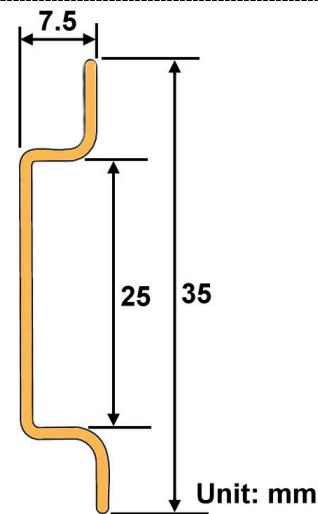

**Figure 2.6.3**

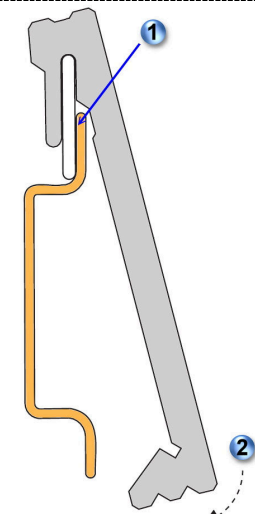

**Figure 2.6.4**

### **2.7 Industrial VDSL2 Application**

The router's line port supports 100Mbps/0.3km for data service across existing phone wiring. It is easy-to-use which do not require installation of additional wiring. Every modular phone jack in the home can become a port on the LAN. Networking devices can be installed on a single telephone wire that can installation within suitable distance (depends on speed) (Figure 2.7)

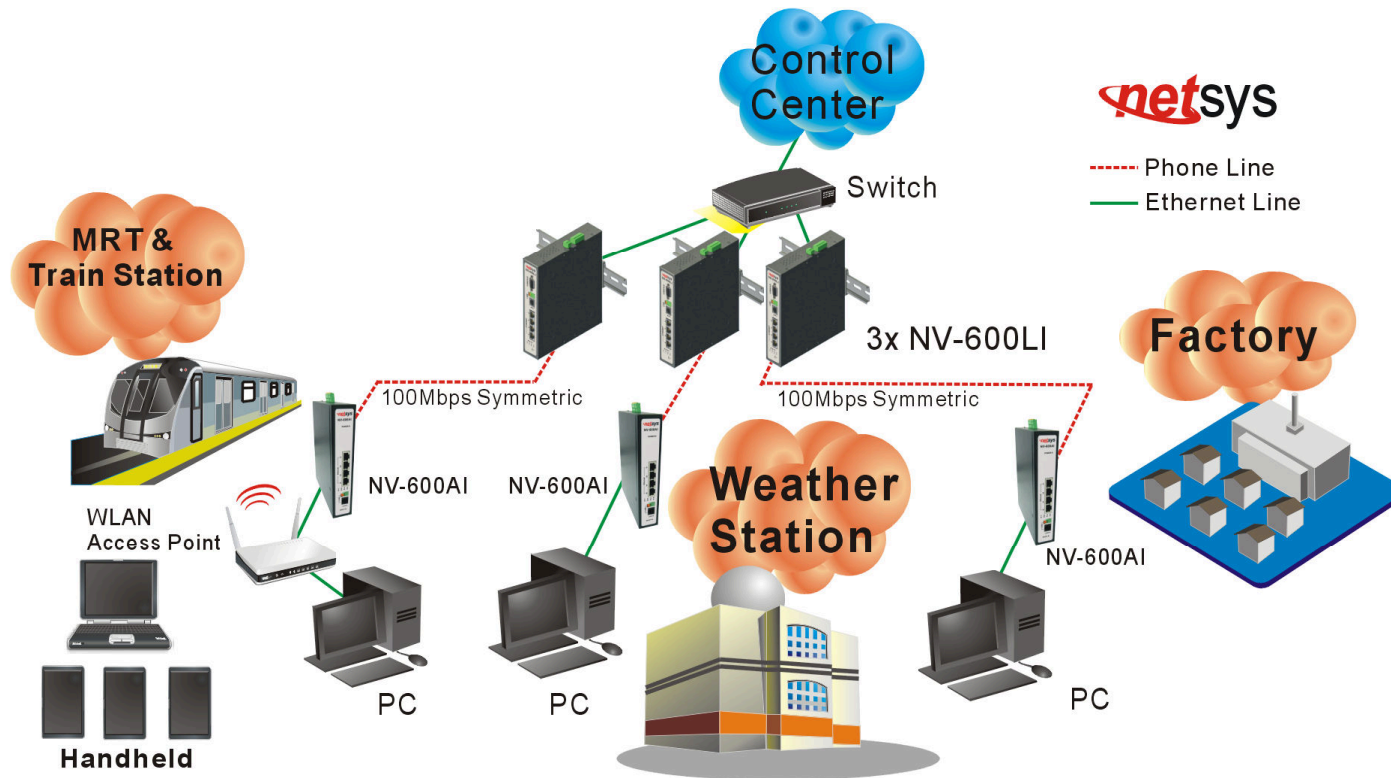

**Figure 2.7 NV-600LI/AI application**

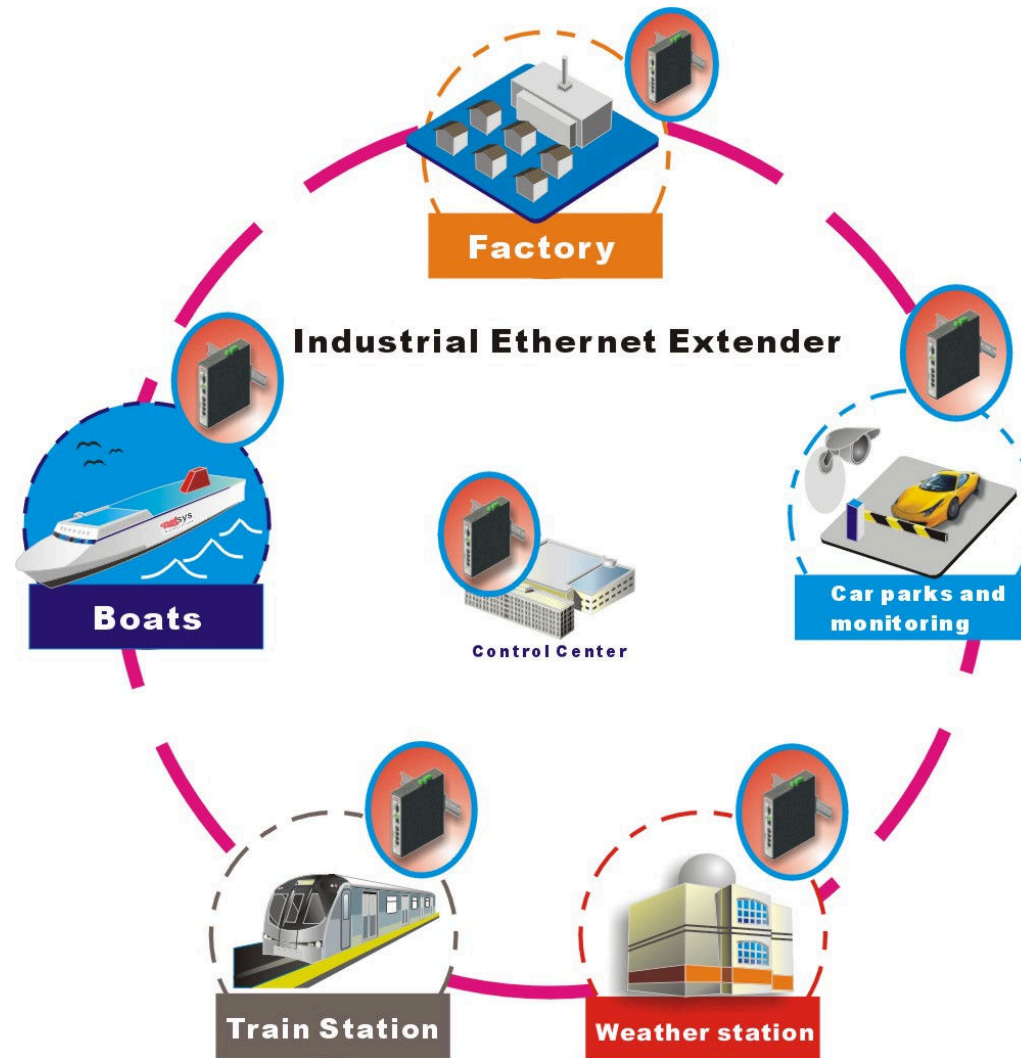

**Figure 2.7.1 NV-600LI/AI industrial-grade application**

◆ **2.7.1 Connect the NV-600LI and the NV-600AI to the Line**

The objective for VDSL2 is to pass high speed data over a twisted pair cable. In the setup, connect NV-600LI to NV-600AI through phone wire(24~26 AWG) or line simulator or any other hardware representation of a cable network, with or without noise injection and crosstalk simulations.

◆ **2.7.2 Connect the NV-600LI and the NV-600AI to LAN Devices**

In the setup, usually an Ethernet tester serves as a representation of the LAN side as well as a representation of the WAN side.

◆ **2.7.3 Run Demos and Tests**

The Ethernet tester may send data downstream as well as upstream. It also receives the data in order to check the integrity of the data transmission. Different data rates can be tested under different line conditions.

## Chapter 3. Hardware Description

This section describes the important parts of the vdsl2 router. It features the front panel and rear panel.



**NV-600AI Outward**

### **3.1 Front Panel**

The figure shows the front panel. (Figure 3.1)

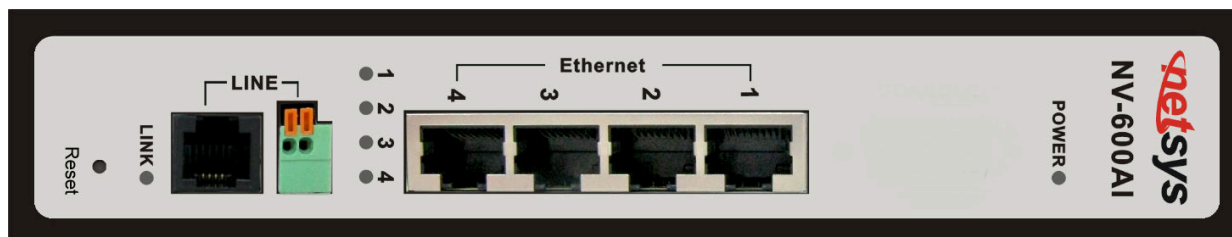

**Figure 3.1 Front Panel(NV-600AI)**

### **3.2 Front Indicators**

The router has **Six** LED indicators. The following Table shows the description. (Table 3-1)

**Table 3-1 LED Indicators Description and Operation**

LED	Color	Status	Descriptions
POWER (Power LED)	Green	On(Steady)	Lights to indicate that the VDSL2 router had power
		Off	The device is not ready or has malfunctioned.
1 ~ 4 (Ethernet LED)	Green	On(Steady)	The device has a good Ethernet connection.
		Blinking	The device is sending or receiving data.
		Off	The LAN is not connected or has malfunctioned.
LINK (VDSL2 LED)	Green	On(Steady)	The Internet or network connection is up.
		Fast Blinking	The device is sending or receiving data.
		Slow Blinking	The Internet or network connection is down.

**Table 3-2** Description of the router connectors

Connectors	Type	Description
Reset	Reset Button	The reset button allows users to reboot the VDSL2 or load the default settings. <b>Press and hold for 1-5 seconds: Reboot the VDSL2 Router</b> <b>Press over 5 seconds: Load the default settings</b>
Line	RJ-11/Terminal Block	For connecting to a VDSL2 device. ( <b>Do not</b> use RJ11 and Terminal Block at the same time.)
Gigabit Ethernet (E1-E4)	RJ-45	For connecting an Ethernet equipped device.
Link (WAN)	RJ-11/Terminal Block	Allows data communication between the router and the VDSL2 network. ( <b>Do not</b> use RJ11 and Terminal Block at the same time.)

**Note:**

It is normal for the connection between two Routers to take up to 3 minutes, due to NV-600LI/AI to establish a link mechanism in auto-negotiation, that detects and calculates CO and CPE both PBO and PSD level, noise levels and other arguments for getting a better connection.

### 3.3 Rear Panel

The following figure shows the rear panel. (Figure 3.3)

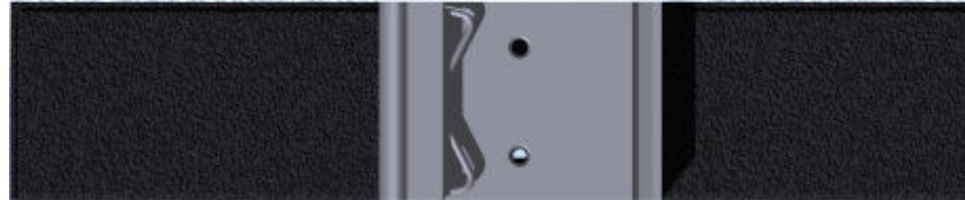

**Figure 3.3 Rear Panel**

**Note:**

Please refer to the section 2.6 to install DIN RAIL.

### 3.4 Side Panel

The following figure shows the side. (Figure 3.4)

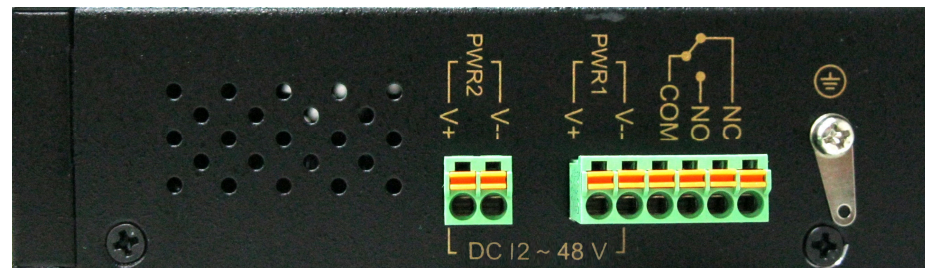

**Figure 3.4 Rear connectors**

The following description introduce Dual power and Relay Contact.



## Wiring the dual Power Inputs

The NV-600LI/AI has two sets of power inputs, power 1 and power 2, which are located on the NV-600AI's side panel. Power 1 pins are the bottom two contacts of the upper 6-contact terminal block and power 2 pins are the only two contacts on the lower 2-contact terminal block.

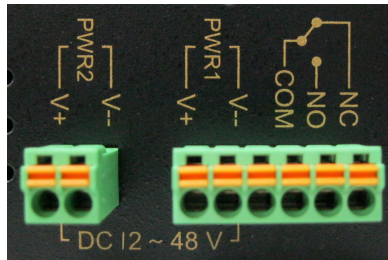

**STEP 1:** Insert the negative/positive DC wires into the V-/V+ terminals, respectively.

**STEP 2:** Place the DC wires into terminal block connector: Push the orange switch of the terminal block with a small flat-blade screwdriver, then the DC wires insert the orange button below of the circle hole, and release the small flat-blade screwdriver.

**STEP 3:** Insert the plastic terminal block connector prongs into the terminal block receptor, which is located on the NV-600AI's side panel.

### Attention:

1. Please note that the negative DC wire must connect into the V- terminal, positive DC wire must connect V+ terminal. If contrary to the location of the wiring, NV-600AI will enable Reverse Polarity Protection function automatically. DC power will not be able to directly through the machine.
2. Please note that if the DC power current exceeds 3A, NV-600AI will enable Overload Current Protection function automatically. DC power will not be able to directly through the machine.

### Safety Caution!

1. Be sure to disconnect the power when installing(uninstalling) the terminal block and power cable.
2. Please note that the user can use 12~48VDC dual power input(Redundant Power). Do not exceed DC 48V.
3. Be sure to disconnect the power before installing and/or wiring your NV-600AI router.
4. Please calculate the maximum possible current in each power wire and common wire. Observe all electrical codes dictating the maximum current allowable for each wire size. If the current goes above the maximum ratings, the wiring could overheat, causing serious damage to your equipment.

## Power Input Status

The following Table shows the examples of the power input status. (Table 3-4)

**Table 3-4**

		Example 1				Example 2				Example 3			
Power Item	Default Polarity	Power Input1	Output State1	Power Input2	Output State2	Power Input1	Output State1	Power Input2	Output State2	Power Input1	Output State1	Power Input2	Output State2
Power 1	-	12V-	OFF	12V-	ON	12V+	Protection	12V+	Protection	48V-	ON	No Power	OFF
	+	12V+		12V+		12V-		48V+					
Power 2	-	24V-	ON	No Power	OFF	24V-	ON	No Power	OFF	48V-	ON	48V-	ON
	+	24V+				24V+				48V+		48V+	

		Example 4				Example 5				Example 6			
Power Item	Default Polarity	Power Input1	Output State1	Power Input2	Output State2	Power Input1	Output State1	Power Input2	Output State2	Power Input1	Output State1	Power Input2	Output State2
Power 1	-	12V-	Malfunction	12V-	Malfunction	12V-	ON	12V-	Malfunction	48V-	ON	No Power	OFF
	+	12V+		12V+		12V+		48V+					
Power 2	-	60V-	Malfunction	No Power	Malfunction	No Power	OFF	60V-	Malfunction	48V+	Protection	48V+	Protection
	+	60V+						60V+		48V-		48V-	

### Notes:

1. State 1 always happens before State 2.
2. Protection means enable Reverse Polarity Protection function.
3. Please note that if use different DC voltage, higher voltage will feeding to NV-600LI or NV-600AI.
4. Please note that the warranty is void if DC 48V power input is exceeded.

## Wiring the Relay Contact

The NV-600AI has a set of relay outputs. The relay contact uses of the terminal block's contacts located on the NV-600AI's side panel. Refer to the following table shows how to connect the wires to the terminal block connector. In this section, we illustrate the meaning of the two contacts used to connect the relay contact.

### Fault Tip:

The relay contacts of the 3-pins terminal block connector are used to detect a power failure warning event. Wires connected to Warning Device over normal open contact (COM & NO) for detecting power system. If power failure not occurred, the fault circuit remains open. The current carrying capacity of relay contact is 1 A @ 24 VDC/ @ 125 VAC. This function triggered by built-in relay.

The following Table shows the Relay circuit and power status. (Table 3-5)

**Table 3-5** Relay Circuit Status and Power good/failure Status.

	Power good	COM & NC	Open Circuit
		COM & NO	Short Circuit
	Power failure	COM & NC	Short Circuit
		COM & NO	Open Circuit

### Grounding the NV-600AI

NV-600AI is designed to enhance EMS performance by grounding. NV-600AI come with metal DIN-Rail brackets for grounding the switches. For optimal EMS performance, connection of the right of the NV-600AI side panel ground lug to the grounding point.

### Before user installed power and device, please read and follow these essentials:

- ◆ Use separate paths to route wiring for power and devices. If power wiring and device wiring paths must cross, make sure the wires are perpendicular at the intersection point.

#### Note:

Do not run signal or communications wiring and power wiring through the same wire conduit. To avoid interference, wires with different signal characteristics should be routed separately.

- ◆ You can use the type of signal transmitted through a wire to determine which wires should be kept separate. The rule of thumb is that wiring sharing similar electrical characteristics can be bundled together.
- ◆ You should separate input wiring from output wiring.
- ◆ We recommend that you mark all equipment in the wiring system.

## **Chapter 4. Configure the NV-600AI Via Web Browser**

The NV-600AI provides a built-in HTML based management interface that allows configuration of the NV-600AI via Internet Browser. Best viewed using Chrome or Firefox browsers.

In order to use the web browser to configure the device, you may need to allow:

- Web browser pop-up windows from your device. Web pop-up blocking is enabled by default in windows XP SP2 or above.
- Java Scripts. (Enabled by default)
- Java permissions. (Enabled by default)

Launch your web browser and input the IP address [192.168.16.249](#) (NV-600LI) or [192.168.16.254](#) (NV-600AI) in the Web page.

## 4.1 Login

The default username is “admin” and password is “admin”, too. The password is changeable in Administrator Settings.



The screenshot shows a web form titled "CPE LOGIN". It contains two input fields: "Username:" with the text "admin" and "Password:" with five dots. Below the fields are two buttons: "LOGIN" and "CANCEL".

**Figure 4.1 Login Password**

### 4.1.1 Home

After successful login using the username **admin**, the home page of NV-600AI is loaded in web browser for NV-600AI. User can also click the "Home" on the left navigation bar. The home page displays the information screen as shown in [Figure 4.1.1](#)

Version Information	
Software Version	B.1
DSL Firmware version	5.4.8.0.0.6 5.4.4.4.0.1, 5.4.8.0.0.6 5.4.4.4.0.1

xDSL Information	
Connected Standard	
Modem Status	SILENT

Default WAN Connection	
Wan Mode	VDSL-PTM
Link Status	UNCONFIGURED
IP Address	UNDEFINED
Connection Type	PPPoE
DNS Server	168.95.1.1
	168.95.1.1

LAN Information	
IP Address	192.168.16.207
DHCP Mode	Disabled

Ethernet PHY Port Status	
PORT-1	Link Down
PORT-2	Link Down
PORT-3	Link Up, 100Mb/s, Full Duplex
PORT-4	Link Up, 1000Mb/s, Full Duplex

**Figure 4.1.1 Home Information**

The screen contains the following details:

**Fields in Home page**

Field	Description
<b>Version Information</b>	
Software Version	Shows the current version of NV-600AI Software loaded on the device.
DSL Firmware version	Shows the current version of xDSL firmware loaded on the device. Applicable only for DSL platforms.
<b>xDSL Information</b>	
Connected Standard	The DSL Standard which is being used currently between DSL CPE and DSLAM.
Modem Status	Displays the status of the physical xDSL Line in terms of the modem and mode selected.
<b>Default WAN Connection</b>	
Wan Mode	Current WAN mode being used in CPE.
Link Status	Shows the status of default WAN connection.
IP Address	Shows the IP address of default WAN connection.
Connection Type	Shows the Connection Type information of default WAN connection.
DNS Server	Shows the primary and secondary DNS servers configured in default WAN connection.
<b>LAN information</b>	
IP Address	Shows the IP address of LAN interface of CPE. This IP address to be used for accessing the CPE device from LAN side e.g. Web UI or UPnP sessions.
DHCP Mode	Shows the DHCP Mode on LAN interface of CPE device.
<b>Ethernet PHY Port Status</b>	
PORT-1 ~PORT-4	Shows the status of first to fourth ethernet port of CPE device.



## 4.1.2 Quick Setup

The **Quick Setup** is located on the left side of the screen. Quick Setup provides a simple and easy step for applying minimal configuration to CPE device, for making it ready to use. The **CPE Quick Setup** window is displayed as shown in [Figure 4.1.2](#). Click on Quick Setup to view and configure the following connections.

Quick Configuration of default WAN connection to Service Provider's network.

**WAN Setup**

**Default WAN Connection Setup**

Channel VlanId

Connection Type

Username  Password

**Figure 4.1.2 Quick Setup**

◆ **WAN Setup**

When the user clicks on Quick Setup, the **WAN Setup** tab is displayed as shown in [Figure 4.1.2.1](#). The **WAN Setup** enables the user to configure the default WAN connection. The user has to supply fields and the CPE device will take all necessary actions to ensure the default WAN is configured. In case, the WAN connection is already existing in CPE device, the same gets re-created with newly supplied attributes from the user. The default WAN Setup configuration shows the Bridged status.

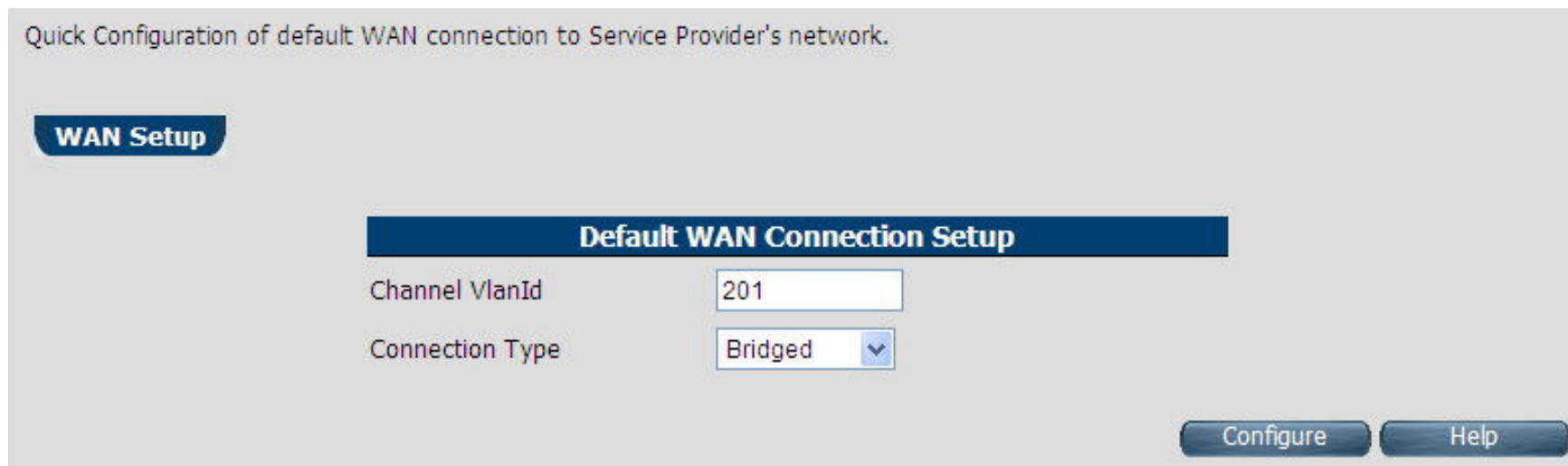

**Figure 4.1.2.1 WAN setup Bridged**

The screen contains the following details:

**Fields in Home page**

Field	Description
Channel VlanId	Specify VLAN Id. Reserved or internally used VLANs that can not be configured in Quick WAN Setup are listed.
Connection Type	Specify the Connection Type from the dropdown. Available options are <b>Bridged</b> , <b>Dynamic</b> and <b>Static</b> .

- ◆ Click **Configure** to configure the default WAN connection setup.

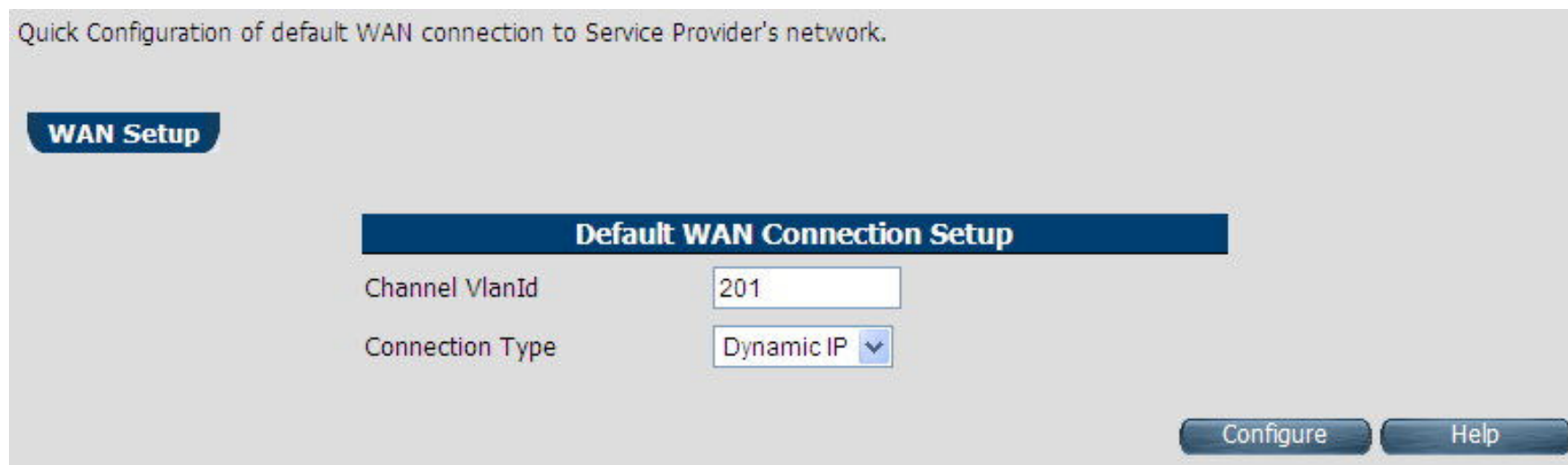

**Figure 4.1.2.2 WAN setup Dynamic IP**

The screen contains the following details:

**Fields in WAN setup Dynamic IP**

Field	Description
Channel VlanId	Specify VLAN ID.
Connection Type	Specify the Connection Type from the dropdown.

- ◆ Click **Configure** to configure the selected WAN connection setup.

Quick Configuration of default WAN connection to Service Provider's network.

**WAN Setup**

**Default WAN Connection Setup**

Channel VlanId

Connection Type

Username  Password

**Figure 4.1.2.3 WAN setup PPPoE**

The screen contains the following details:

**Fields in WAN setup PPPoE**

Field	Description
Channel VlanId	Specify VLAN Id.
Connection Type	Specify the Connection Type from the dropdown.
Username	Enter a valid Username.
Password	Enter a valid Password.

- ◆ Click **Configure** to configure the selected WAN connection setup.

Quick Configuration of default WAN connection to Service Provider's network.

**WAN Setup**

**Default WAN Connection Setup**

Channel VlanId	<input type="text" value="201"/>
Connection Type	<input type="button" value="Static IP"/> ▾
IP address	<input type="text"/> . <input type="text"/> . <input type="text"/> . <input type="text"/>
Subnet Mask	<input type="text"/> . <input type="text"/> . <input type="text"/> . <input type="text"/>
Gateway	<input type="text"/> . <input type="text"/> . <input type="text"/> . <input type="text"/>

**Figure 4.1.2.4 WAN setup Static IP**

The screen contains the following details:

### Fields in WAN setup Static IP

Field	Description
Channel VlanId	Specify VLAN Id.
Connection Type	Specify the Connection Type from the dropdown.
IP Address	Specify the IP Address of NV-600AI CPE's WAN link.
Subnet Mask	Specify the Subnet Mask of NV-600AI CPE's WAN link.
Gateway	Specify the Gateway address of the NV-600AI CPE's WAN.

- ◆ Click **Configure** to configure the selected WAN connection setup.

**Note:**

When WAN mode is other than ATM, the corresponding web pages will be available in WAN setup. Those web pages will not ask user for fields like ATM VCC etc.

## 4.2 Select the Menu Level

There is an easy Setup for end users at the setup of NV-600AI with **SYSTEM**, **Statistics**, **xDSL**, **WAN**, **LAN**, **Route**, **FIREWALL**, **NAT**, **QoS**, **Multicast**, **Ipssec**, **IPv6**, **Diagonstics**, **Quick Setup**, **Home**, **Logout** for more detail configurations.

The screenshot shows the web interface of the NV-600AI router. On the left is a vertical menu with the following items: System, Statistics, xDSL, WAN, LAN, Route, Firewall, NAT, QoS, Multicast, IPsec, IPv6, Diagnostics, Quick Setup, Home, and Logout. The main content area displays the 'Version Information' page, which contains several tables of system data.

Version Information	
Software Version	B.1
DSL Firmware version	5.4.8.0.0.6 5.4.4.4.0.1, 5.4.8.0.0.6 5.4.4.4.0.1
xDSL Information	
Connected Standard	
Modem Status	IDLE_REQUEST
Default WAN Connection	
Wan Mode	VDSL-PTM
Link Status	UNDEFINED
IP Address	UNDEFINED
Connection Type	Bridge
DNS Server	
LAN Information	
IP Address	192.168.16.207
DHCP Mode	Disabled
Ethernet PHY Port Status	
PORT-1	Link Down
PORT-2	Link Down
PORT-3	Link Up, 100Mb/s, Full Duplex
PORT-4	Link Up, 100Mb/s, Full Duplex

A 'Help' button is located at the bottom right of the main content area.

**Figure 4.2 Select the Menu Level (NV-600AI)**

### 4.3 Select "SYSTEM"

Select the "SYSTEM". The menu below will be used frequently. It includes the sub-menus of **Host Name Config**、**System Time**、**Administrator Settings**、**Web Settings**、**Software/Firmware Upgrade**、**System Log**、**SSL Certificat**、**Mac Table Aging Time**、**Vlan Tag Pass Through** and **Reset**. A screen is displayed as shown in [Figure 4.3](#)

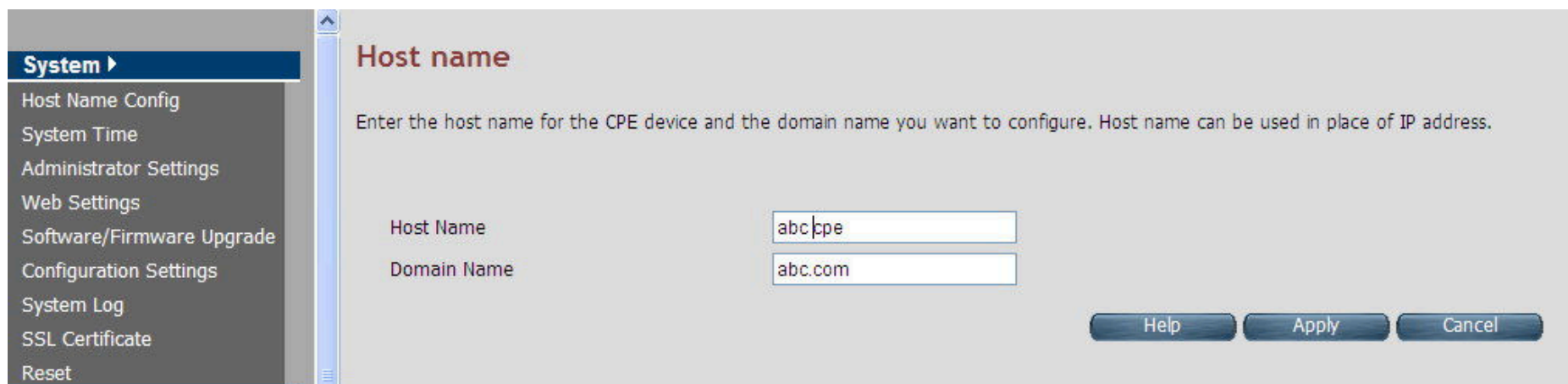

**Figure 4.3 System Setup**



### 4.3.1 Host Name Config

To configure the host name of NV-600AI, you have to enter host and domain name. Click the **Host Name Config** link (**System > Host Name Config**) on the left navigation bar. A screen is displayed as shown in [Figure 4.3.1](#).



**Figure 4.3.1 Host Name Config**

#### Fields in Host Name Config

Field	Description
Host Name	Enter the host name of the VDSL2 CPE. This is used to address VDSL2 CPE, by using this name instead of typing the IP address. Maximun Characters: 60.
Domain Name	Enter the domain name of the VDSL2 CPE. Maximun Characters: 60.

- ◆ Click **Apply** at any time during configuration to save the information that you have entered.

- ◆ Click **Cancel** to exit from this page without saving the changes.

### 4.3.2 System Time

You can set System Time by connecting to a **Simple Network Time Protocol (SNTP)** server allows the Modem to synchronize the system clock to the global Internet. The synchronized clock in the Modem is used to record the security log and control client filtering. This page provides the time zone selection and NTP (Network Time Protocol) configuration. Click the **System Time** link (**System > System Time**) on the left navigation bar and a screen is displayed as shown in [Figure 4.3.2](#).

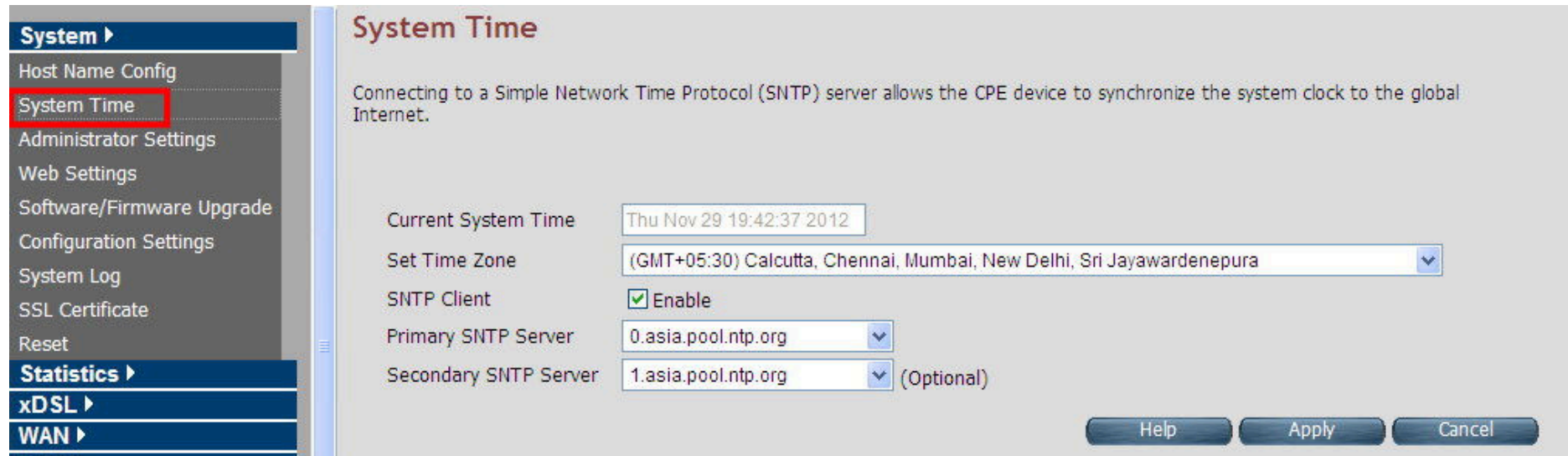

**Figure 4.3.2 System Time Configuration**

### Fields in System Time

Field	Description
Current System Time	Current Time in System shown in Day, Date and Time of day.
Set Time Zone	Select the time zone form the list of worldwide time zones in pull-down options.
SNTP Client	Tick on Check box, if SNTP client has to be enabled.

### Fields in System Time(Cont'd)

Field	Description
Primary SNTP Server	Main NTP Server to be selected form dropdown list.
Secondary SNTP Server	Backup NTP Server (optional).

- ◆ Click **Apply** at any time during configuration to save the information that you have entered.
- ◆ Click **Cancel** to exit from this page without saving the changes.

### Note:

**Static Routing functionality is used to define the connected Gateway between the LAN and WAN.** For example, if we want to activate the Network Time Protocol (NTP) service, and we have to define the Gateway connected to NTP server in the WAN. Please refer to “static routing” for your reference.

### 4.3.3 Administrator Settings

To change the password for the administrator, click the **Administrator Settings** link (**System > AdministratorSettings**) in the left navigation bar. A screen is displayed as shown in [Figure 4.3.3](#). This page allows the user to change the login password.

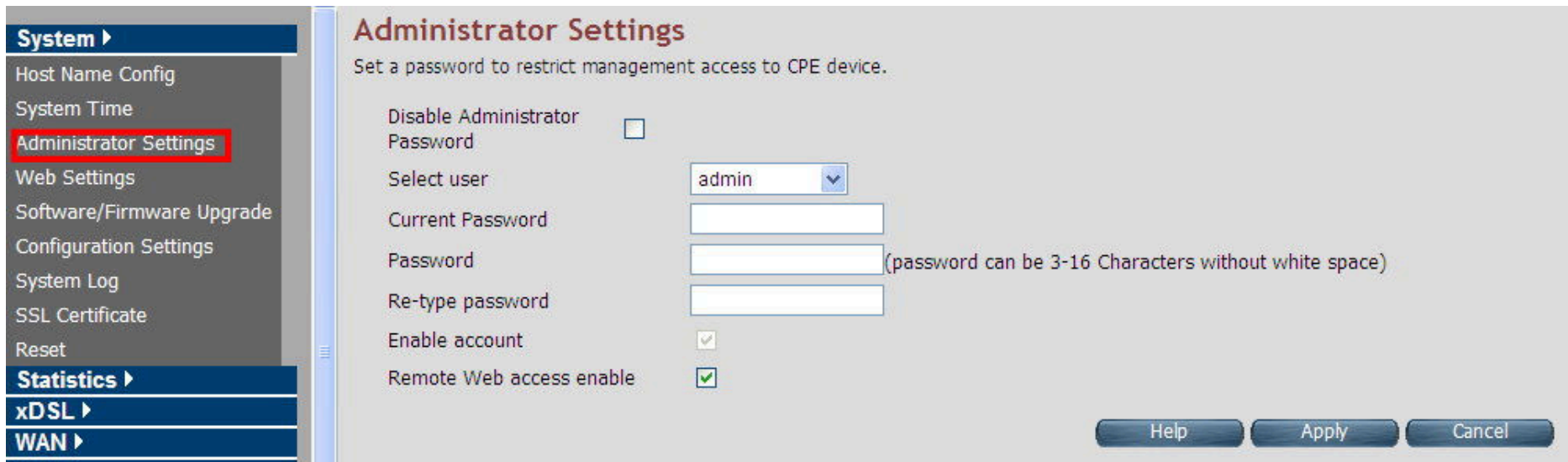

**Figure 4.3.3 Administrator Settings**

### Fields in AdministratorSettings

Field	Description
Disable Administrator Password	Select this to disable the web prompts for user login password.
Select User	Select user type. The available options are <b>Admin</b> and <b>support_user</b> .
Current Password	The user should specify the current login password.
Password	The user should specify the new password desired. The password should be at least 3 characters and not more than 16 characters in length without a white space.

### Fields in AdministratorSettings (Cont'd)

Field	Description
Re-type Password	The user should re-type the new password entered in previous field.
Enable Account	To enable the user account login.
Remote Web Access Enable	To enable web access from WAN side.

- ◆ Click **Apply** at any time during configuration to save the information that you have entered.
- ◆ Click **Cancel** to exit from this page without saving the changes.

### 4.3.4 Web Settings

This page shows the details of Web login timeout settings for the CPE device in seconds. Click the **Web Settings** link (**System > Web Settings**) on the left navigation bar and a screen is displayed as shown in [Figure 4.3.4](#)



**Figure 4.3.4 Web Settings**

#### Fields in Web Settings

Field	Description
Autologout Duration	This is logout duration after which the web session is automatically log-out. The unit is in seconds.

- ◆ Click **Apply** at any time during configuration to save the information that you have entered.
- ◆ Click **Cancel** to exit from this page without saving the changes.

### 4.3.5 Software/Firmware Upgrade

To update the system firmware, click the **Software/Firmware Upgrade** link (**System > Software/Firmware Upgrade**) on the left navigation bar. A screen displays the current version of NV-600AI Software running on the device as shown in [Figure 4.3.5](#)

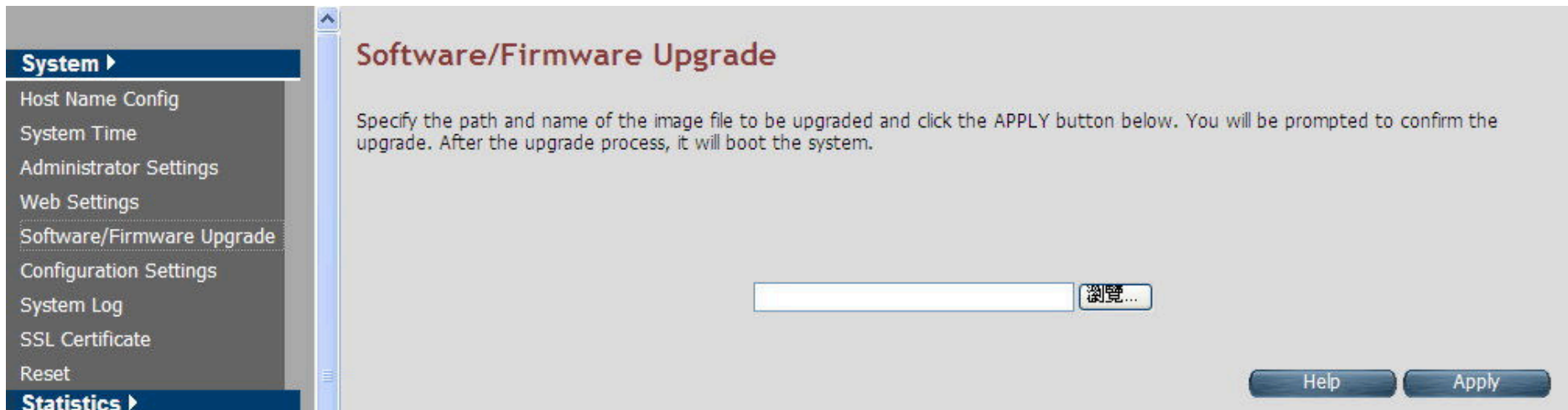

**Figure 4.3.5 Software/Firmware Upgrade**

- ◆ Click **Browse** to specify the software image file from host, to be upgraded in system.
- ◆ Click **Apply** to start the software upgrade process.

**Note:**

Regarding the software current version that you can click home on the left navigation bar to view.

### 4.3.6 Configuration Settings

To manage the configuration of the system, click the **Configuration Settings** link (**System > Configuration Settings**) on the left navigation bar. This page allows users to backup the current configuration of CPE to host PC or restore the previously backed-up configuration in host PC to CPE as displayed in [Figure 4.3.6](#)

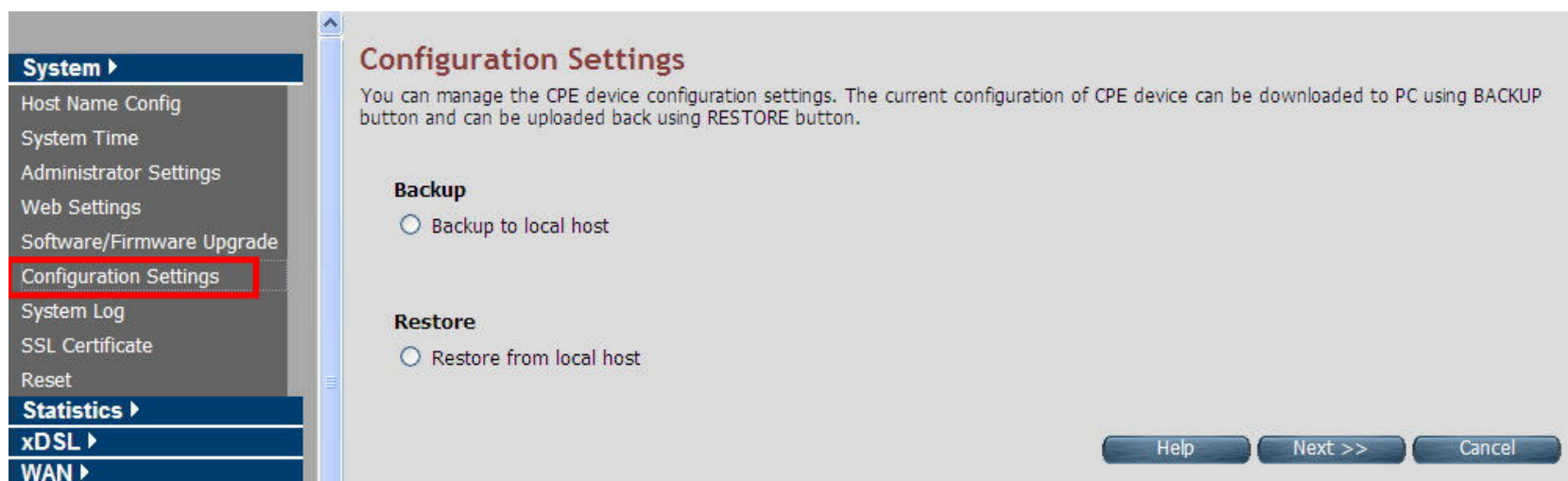

**Figure 4.3.6 Configuration Settings**

#### Fields in Configuration Settings

Field	Description
Backup to local host	This will backup the current active configuration of CPE in Host machine.
Restore from local host	This will load the user supplied configuration to CPE from Host machine.



- ◆ Click **Next** to start the firmware upgrade process.
- ◆ Click **Cancel** to exit from this page without saving the changes.

### ■ Backup Current Active Configuration

As mentioned before this option allows user to backup the current active configuration running in router system. This is very helpful, when a user wants to backup the current working configuration of router for rollbacks, if required in future. It is recommended that before any complex nature of configuration is done by user the current active configuration should be backed up in host machine. The Local Host Configuration backup are shown in [Figure 4.3.6.1](#)

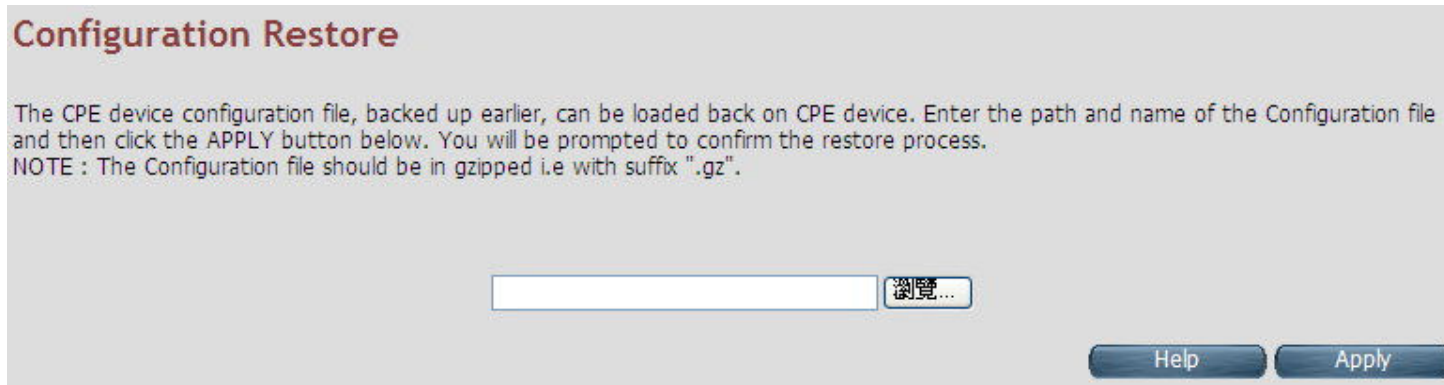

**Figure 4.3.6.1 Configuration Backup**

When you click **Backup** button as shown in [Figure 4.3.6.1](#), it will backup the config settings of CPE in connected PC from where Web UI is being accessed.

■ **Restore Previous Backed-up Configuration**

As mentioned before this option allows user to restore the earlier backed up configuration in router system. This operation is handy for restoring the system to last backed-up configuration mode. The Local Host Configuration restore are shown in [Figure 4.3.6.2](#). The system will go for reboot after configuration is restored. When CPE boots up it will be running with newly applied configuration.

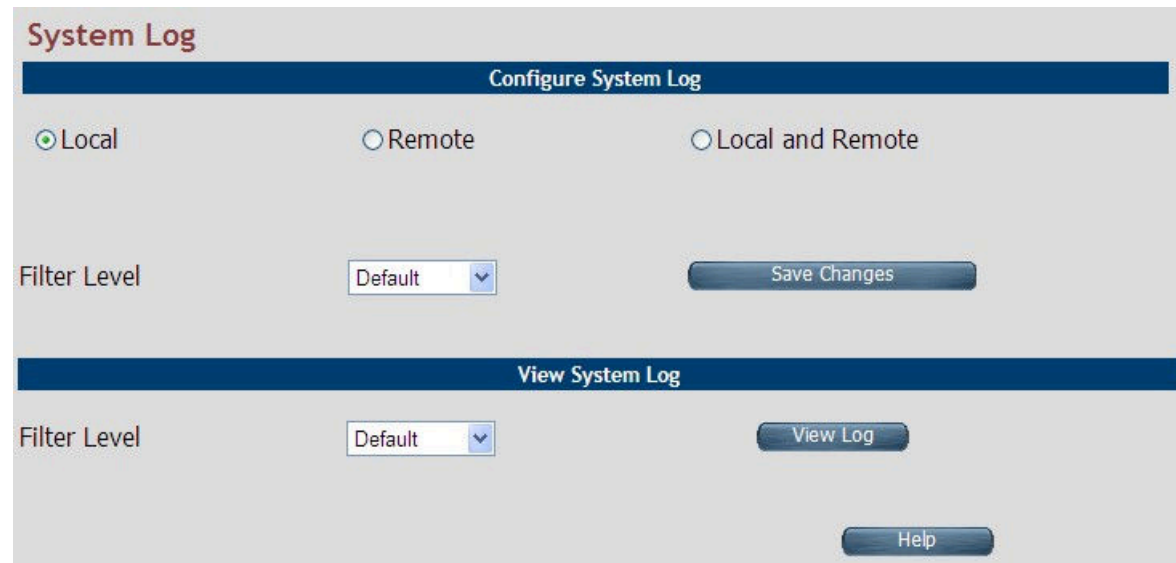

**Figure 4.3.6.2 Configuration Restore**

- ◆ Click **Apply** button to restore the config settings.

### 4.3.7 System Log

To view the logs produced in system, click the **System Log** link (**System > System Log**) on the left navigation bar. A screen is displayed as shown in [Figure 4.3.7](#)



**Figure 4.3.7 System Log**

This page allows to manage logging options in CPE device.

- ◆ If "Local" is selected, the events are logged locally in the system.
- ◆ If "Remote" is selected, the messages are logged to a remote server.

- ◆ If "Local and Remote" option is selected, messages are logged locally in the system as well as to the remote server. The events pertaining to the priority equal to or higher to the selected level will be logged. "Default" level logs all events. For viewing system log, the events corresponding to the priority level equal to or higher than the selected level will be displayed here. The screen contains the following details: **Fields in System Log**

Field	Description
Configure System Log	<p>Select the mode of log. The possible options are:</p> <ul style="list-style-type: none"> <li>◆ <b>Local Mode:</b> The log text is displayed in web browser itself.</li> <li>◆ <b>Remote Mode:</b> Specify the IP address and UDP port number for log transfer using syslog.</li> <li>◆ <b>Local and Remote Mode:</b> This supports both options mentioned above.</li> </ul>
Filter Level	<p>The user can apply one of the following filters to record logging above the specified level. Click on &lt;SAVE CHANGES&gt; button for applying the log level selection.</p> <ul style="list-style-type: none"> <li>◆ <b>Default:</b> The default pre-selected levels of logs are recorded.</li> <li>◆ <b>Debug:</b> Debug and above levels of logs are recorded.</li> <li>◆ <b>Info:</b> Informative and above level of logs are recorded.</li> <li>◆ <b>Notice:</b> Notice type and above level of logs are recorded.</li> <li>◆ <b>Warning:</b> Warning type and above levels of logs are recorded.</li> <li>◆ <b>Error:</b> Error type and above levels of logs are recorded.</li> <li>◆ <b>Critical:</b> Critical type and above levels of logs are recorded.</li> <li>◆ <b>Alert:</b> Alert type and above level of logs are recorded.</li> <li>◆ <b>Emerg:</b> Emergency type of log information is recorded.</li> </ul>
View System Log	<p>The user can apply one of the following filters to view specific logs of certain level:</p> <ul style="list-style-type: none"> <li>◆ <b>Default:</b> The default pre-selected levels of logs are viewed.</li> <li>◆ <b>Debug:</b> Debug and above levels of logs are viewed.</li> <li>◆ <b>Info:</b> Informative and above level of logs are viewed.</li> <li>◆ <b>Notice:</b> Notice type and above level of logs are viewed.</li> <li>◆ <b>Warning:</b> Warning type and above levels of logs are viewed.</li> <li>◆ <b>Error:</b> Error type and above levels of logs are viewed.</li> <li>◆ <b>Critical:</b> Critical type and above levels of logs are viewed.</li> <li>◆ <b>Alert:</b> Alert type and above level of logs are viewed.</li> </ul>

◆ **Emerg:** Emergency type of log information is viewed.

- ◆ Click **Save Changes** to configure the system log settings.
- ◆ Click **View Log** to fetch the logs in browser.

When you click **View log** button, a screen is displayed as shown in [Figure 4.3.7.1](#). This screen is an example of system log of default level as shown in the browser.



**Figure 4.3.7.1 View System Log**

For the ease of readability, the log messages of different levels are using different colors.

**For example:** all the debug messages are shown in green colored text.

- ◆ Click **Download** to save the file in Host Computer.
- ◆ Click **Clear** to clear the log from the system.
- ◆ Click **Refresh** to get the recent log.
- ◆ Click **Back** to go back to System Log page.

### 4.3.8 SSL Certificate

To install a SSL Certificate for SSL tunnel, click the **SSL Certificate** link (**System > SSL Certificate**) on the left navigation bar. A screen is displayed as shown in [Figure 4.3.8](#)

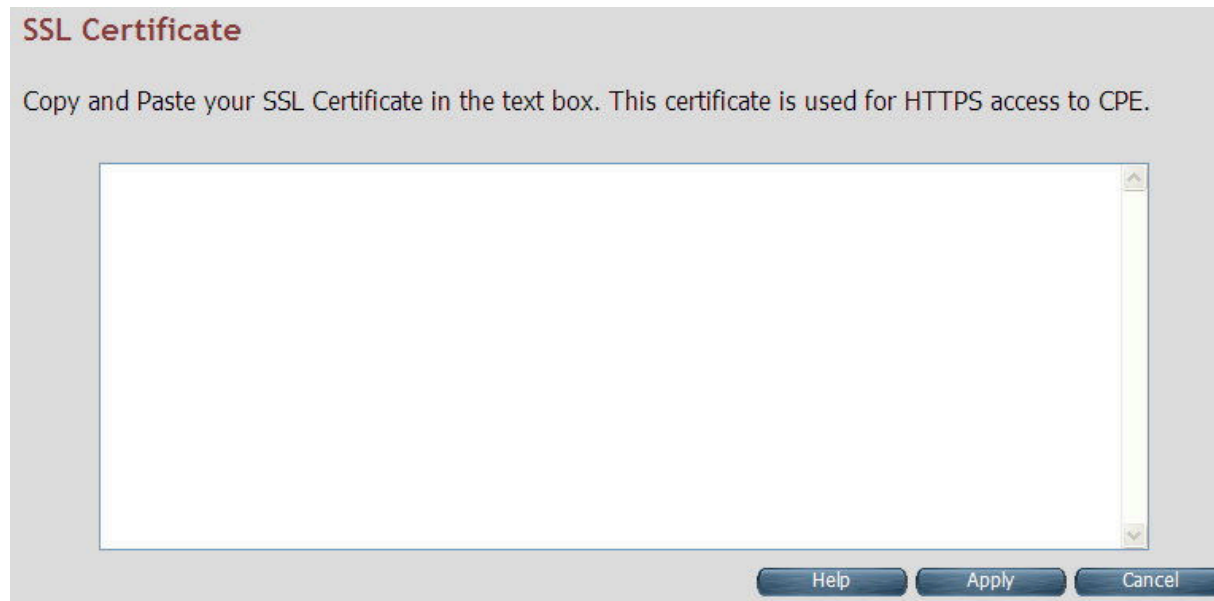
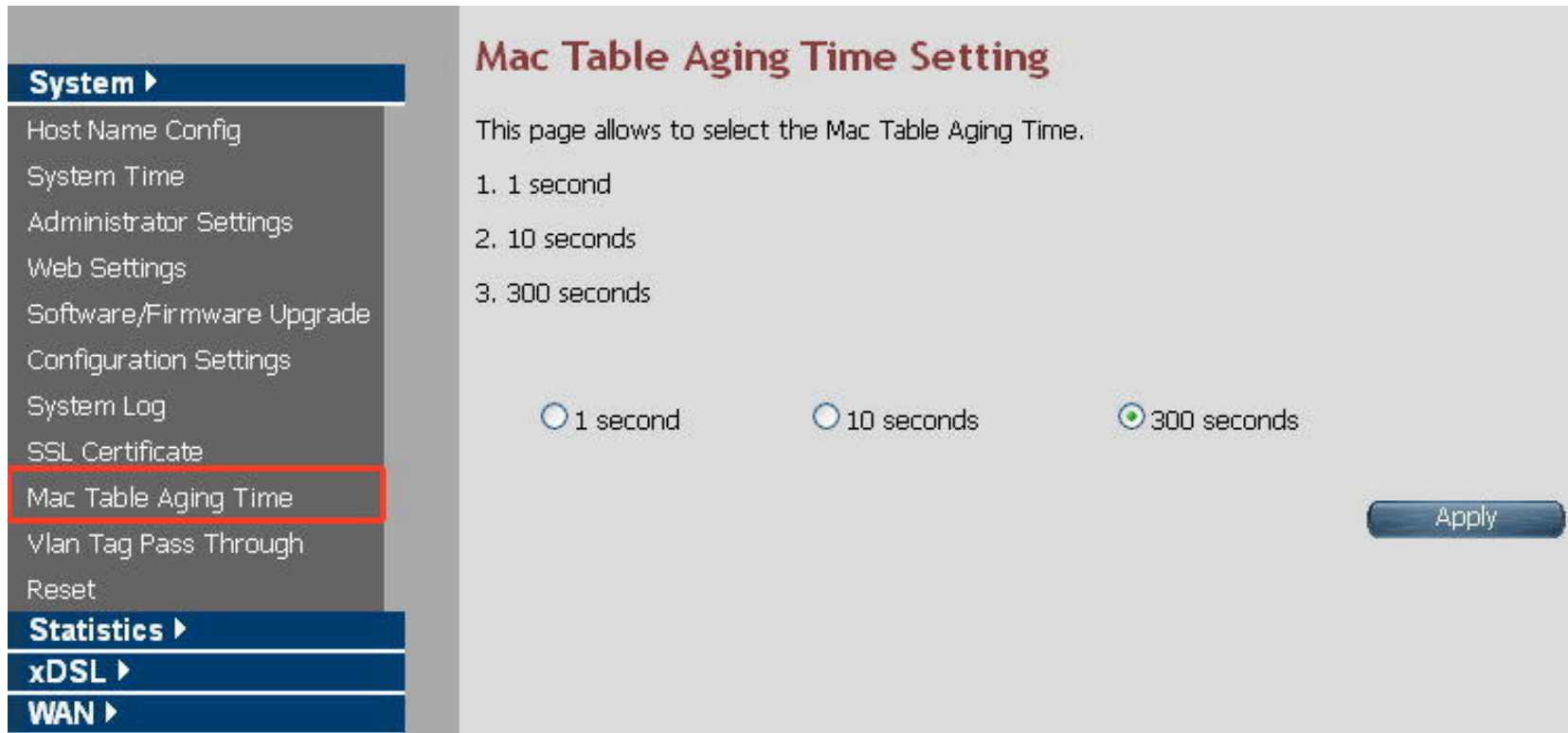

**Figure 4.3.8 SSL Certificate**

- ◆ Click **Apply** to install the entered certificate.
- ◆ Click **Cancel** for cancel the installation of entered certificate.

### 4.3.9 Mac Table Aging Time

Click the **Mac Table Aging Time** on the left navigation bar. This page allows users to select the Mac Table Aging Time in [Figure 4.3.9](#). The default of Mac Table is 300 seconds.

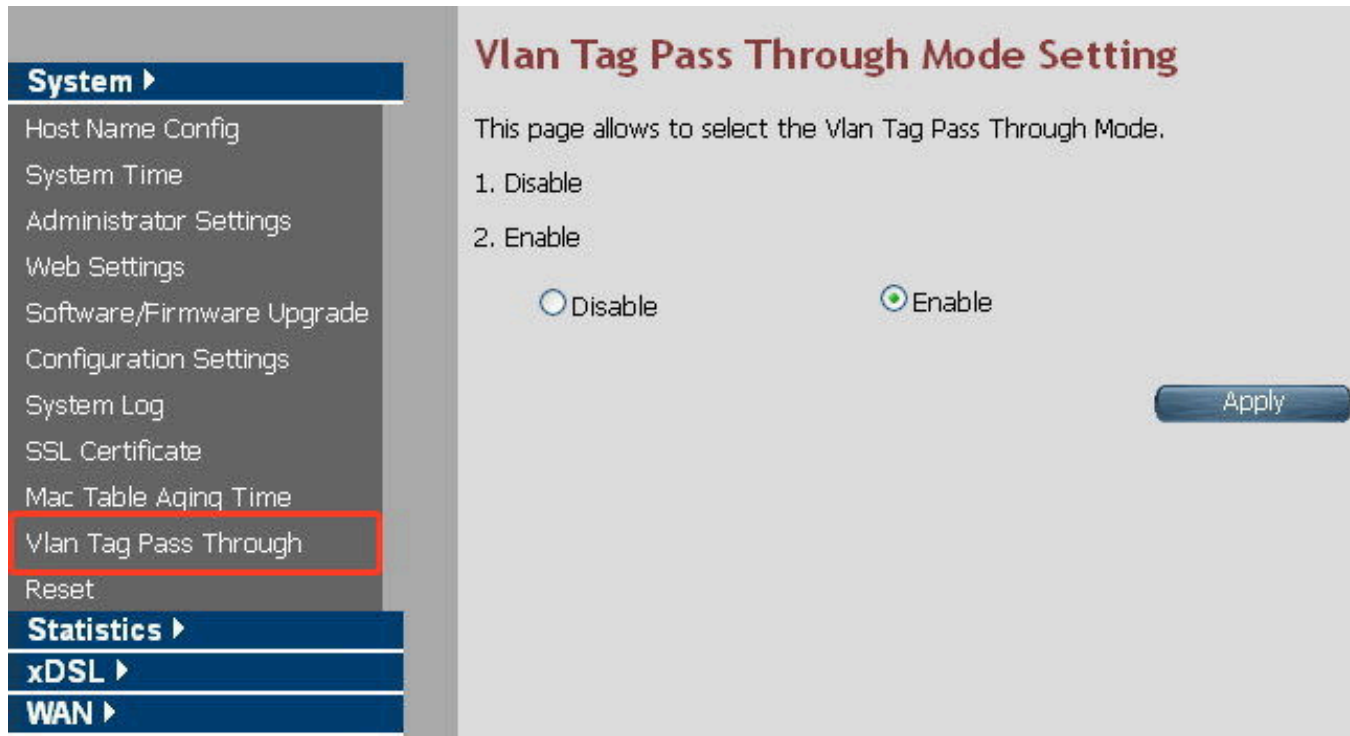

**Figure 4.3.9 Mac Table Aging Time**

- ◆ Click **Apply** button to select Mac Table Aging Time setting. Click **Apply** button to select Mac Table Aging Time setting.

### 4.3.10 Vlan Tag Pass Through Mode Setting

Click the **Vlan Tag Pass Through** on the left navigation bar. This page allows users to select the Vlan Tag Pass Through Mode in Figure 4.3.10



**Figure 4.3.10 Vlan Tag Pass Through Mode**

- ◆ Click **Apply** button to select Vlan Tag Pass Through Mode.



### 4.3.11 Reset

To reboot the system, click **Reset** link (**System > Reset**) on the left navigation bar. A screen is displayed as shown in [Figure 4.3.11](#)

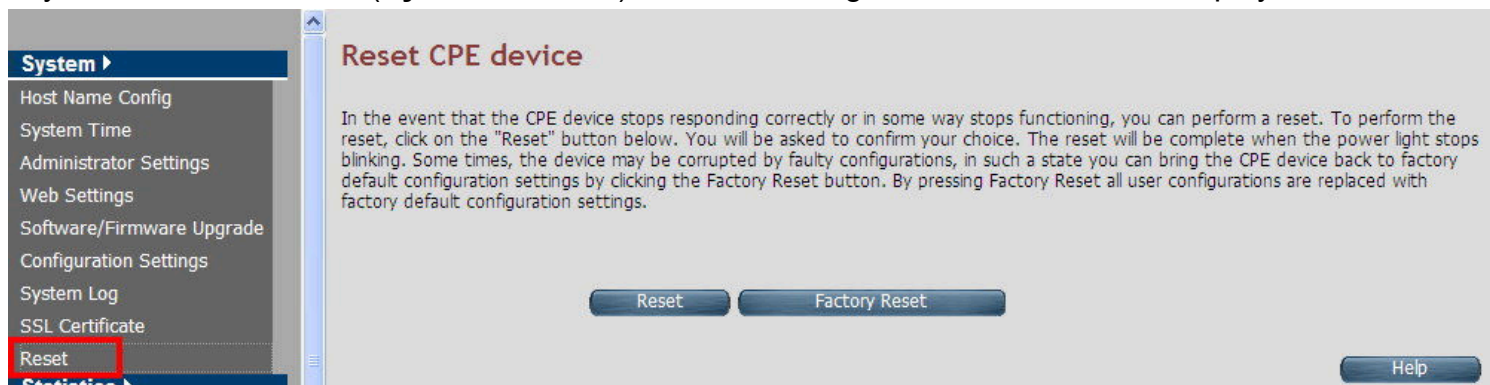

**Figure 4.3.11 Reset**

- ◆ Click **Reset** to reboot the system. This does not change the configurations existing in system.
- ◆ Click **Factory Reset** to reset the device configuration to factory defaults configuration. This operation will result in saving the current configuration and reverted back to factory shipped configuration.

When **Reset** or **Factory Reset** is clicked, a confirmation message is displayed as shown in [Figure 4.3.11.1](#)



**Figure 4.3.11.1 Reset Confirmation Message**

- ◆ Click **Ok** to perform the operation on CPE.
- ◆ Click **cancel** to exit from this page.

#### 4.4 Select “Statistics”

Select the “Statistics” link on left navigation menu. The menu below includes the sub-menus of **LAN** and **WAN**. A screen is displayed as shown in [Figure 4.4](#).



**Figure 4.4 Statistics in the left navigator bar**

### 4.4.1 LAN

To get the LAN Statistics, click the **LAN** link (**Statistics > LAN**) on the left navigation bar. A screen is displayed as shown in [Figure 4.4.1](#)

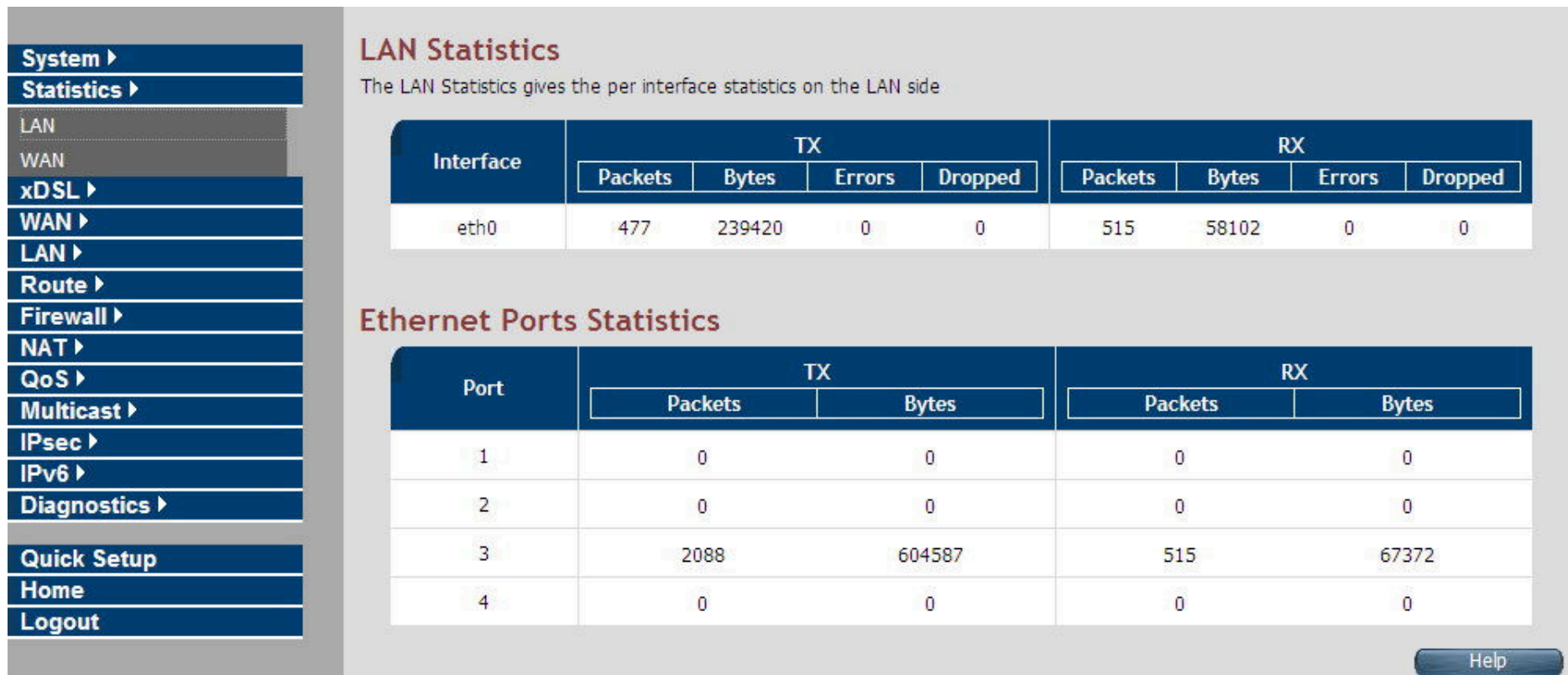

**Figure 4.4.1 Dynamic IP Configuration**

The screen contains the following details:

**Fields in LAN Statistics:**

Field	Description
Interface	Name of LAN Interface (e.g. eth0, usb0 etc.)
TX	Transmit Counters: <ul style="list-style-type: none"> <li>◆ Total packets transmitted from this interface.</li> <li>◆ Total bytes transmitted form this interface.</li> <li>◆ Total Error packets on this interface.</li> <li>◆ Total Dropped packets on this interface.</li> </ul>
RX	Receive Counters: <ul style="list-style-type: none"> <li>◆ Total packets received from this interface.</li> <li>◆ Total bytes received form this interface.</li> <li>◆ Total Erroneous packets on this interface.</li> <li>◆ Total Dropped packets on this interface.</li> </ul>

### 4.4.2 WAN

To get WAN Statistics, click the **WAN** link (**Statistics > WAN**) on the left navigation bar. A screen is displayed as shown in [Figure 4.4.2](#)

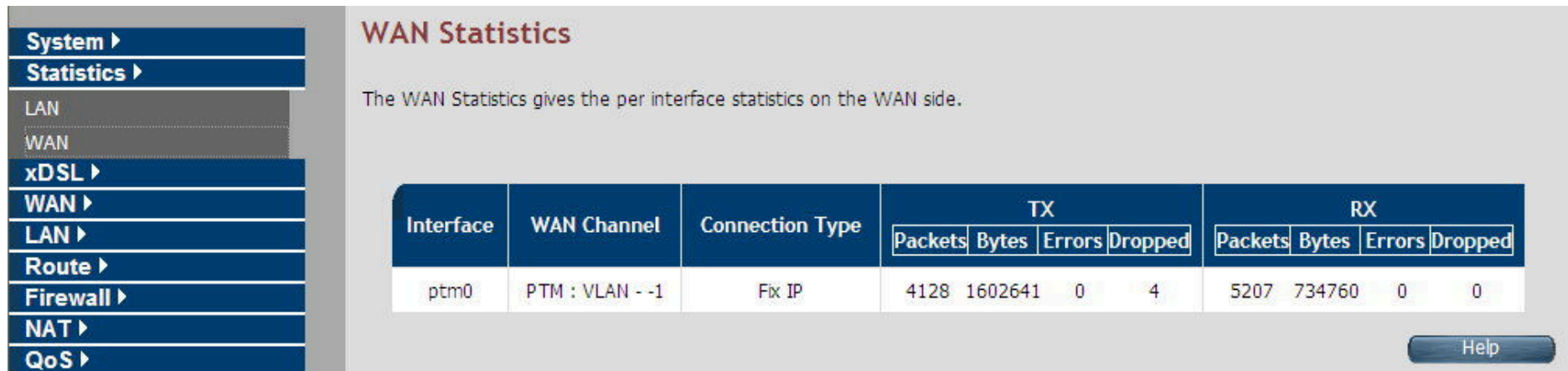

**Figure 4.4.2 IP Settings Configuration**

The screen contains the following details:

**Fields in WAN Statistics:**

Field	Description
Interface	Name of WAN Interface.
WAN Channel	Information about WAN Channel such as VCC or WAN-ethernet channel.
Connection Type	Type of WAN Connection.

**Fields in WAN Statistics (cont'd):**

Field	Description
TX	Transmit Counters for WAN interface: <ul style="list-style-type: none"> <li>◆ Total packets transmitted from this interface.</li> <li>◆ Total bytes transmitted form this interface.</li> <li>◆ Total Errorneous packets transmitted on this interface.</li> <li>◆ Total Dropped packets transmitted on this interface.</li> </ul>
RX	Receive Counters for WAN interface: <ul style="list-style-type: none"> <li>◆ Total packets received from this interface.</li> <li>◆ Total bytes received form this interface.</li> <li>◆ Total Errorneous packets received on this interface.</li> <li>◆ Total Dropped packets on this interface.</li> </ul>

## 4.5 Select “xDSL”

You can view the **xDSL** link on the left navigation bar of the CPE Home page. This web page is available only on DSL platforms. Select the “xDSL”. The menu below includes the sub-menus of **xDSL Status**. A screen is displayed as shown in [Figure 4.5](#).



**Figure 4.5 Select xDSL**

**Note:**

These options help to monitor and configure the DSL physical parameters in the device.

### 4.5.1 xDSL Status

To view the xDSL Status, click the **xDSL Status** link (**xDSL > xDSL Status**) on the left navigation bar. A screen is displayed as shown in [Figure 4.5.1](#)

#### xDSL Line Status

Provides detailed information about xDSL line's current attributes

ATU-C System Vendor Information		
Vendor ID	(B5,00,42,44,43,4D,00,00)	
Vendor Version Number	(76,30,39,2E,30,37,2E,31,35,20,20,20,20,00)	
Vendor Serial Number	(00,00)	

Status	
Modem Status	SHOWTIME, SYNC
Mode Selected	VDSL, 17A
Power Management Mode	DSL_G997_PMS_L0
Trellis-Coded Modulation	Enable
Latency Type	Fast

Rate		
	Downstream	Upstream
Data Rate	100012 kbps	60016 kbps
Maximum Attainable Data Rate(ATTNDR)	140868 kbps	62576 kbps

Information		
	Downstream	Upstream
Interleaver Depth	1	1
Line Attenuation(LATN)	0.1 dB	0.0 dB
Signal Attenuation(SATN)	0.1 dB	0.0 dB
Signal-to-Noise Ratio Margin(SNRM)	16.9 dB	8.6 dB
Actual Aggregate Transmit Power (ACATP)	13.1 dB	11.9 dB

Performance		
	Near End	Far End
Superframe	Not available	
LOS Failure	0	0
LOF Failure	0	0
LPR Failure	0	0
NCD Failure	0	0
LCD Failure	0	0
CRC	0	1793
RS Correction	240	255
Forward Error Correction Seconds(FECS-L)	0	0
Errored Second(ES-L)	0	1672
Severely Errored Seconds(SES-L)	0	116
Loss of Signal Seconds(LOSS-L)	0	108
Unavailable Seconds(UAS-L)	82	82
HEC Error	0	0

Help



**Figure 4.5.1 xDSL Status**

The screen contains the following details:

**Fields in xDSL Status:**

Field	Description
ATU-C System Vendor Information	Displays the Vendor ID, Version Number and the Serial Number of the ATU-C (DSLAM).
Status	Displays the status of the physical xDSL Line in terms of the modem, mode selected, Trellis-Coded Modulation and the Latency Type
Rate	Displays the data rate and the maximum attainable data rate
Information	Displays the information about the xDSL line, in terms of Line Attenuation, Signal Attenuation, Signal to Noise Ratio and other such parameters
Performance	Displays the performance figures of the physical xDSL line

## 4.5.2 Vectoring Mode selection

For viewing the vectoring mode, click the **Vectoring Mode Selection** link (**xDSL > Vectoring Mode Selection**) on the left navigation bar. A screen is displayed as shown in [Figure 4.5.2](#)

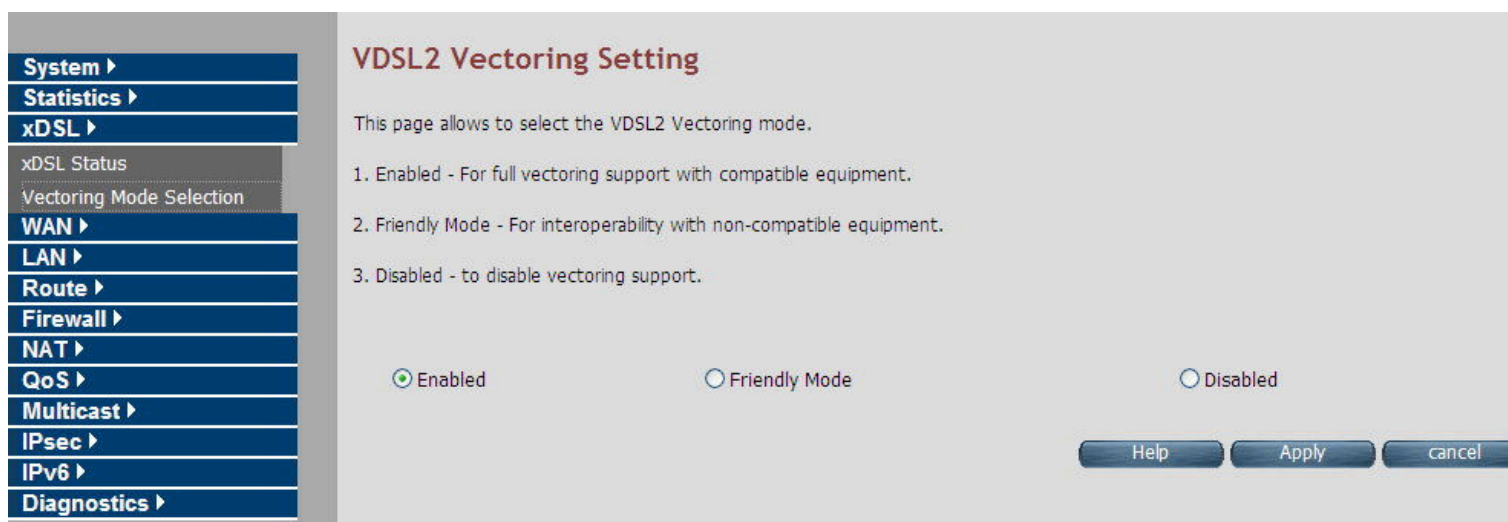

### Fields in Vectoring Mode Selection

Field	Description
Enabled	Enable VDSL2 Full Vectoring mode (Default setting), it will auto follow the CO side vectoring configuration.
Friendly Mode	Enable VDSL2 Vectoring-Friendly mode, it will auto follow the CO side vectoring configuration.
Disabled	Disable VDSL2 Vectoring feature.

**Notes:**

1. NV-600AI vdsl2 vectoring technology default setting is enabled.
2. If user would like to use vectoring technology, NV-600AI and IP DSLAM both need support vectoring technology and need both enabled. NV-600AI will auto follow the IP DSLAM vectoring technology to configure.
3. Vectoring technology does not support point to point applications.

**About vectoring function(Reference only):**

Vectoring is a transmission method that employs the coordination of line signals for reduction of crosstalk levels and improvement of performance. It is based on the concept of noise cancellation, much like noise-cancelling headphones. The ITU-T G.993.5 standard, "Self-FEXT cancellation (vectoring) for use with VDSL2 transceivers" (2010), also known as G.vector, describes vectoring for VDSL2. The scope of Recommendation ITU-T G.993.5 is specifically limited to the self-FEXT (far-end crosstalk) cancellation in the downstream and upstream directions. The far end crosstalk (FEXT) generated by a group of near-end transceivers and interfering with the far-end transceivers of that same group is cancelled. This cancellation takes place between VDSL2 transceivers, not necessarily of the same profile.

## 4.6 Select "WAN"

You can view **WAN** link on the left navigation bar for WAN related settings. Select the "NAT". The menu below includes the sub-menus of **WAN Mode Selection**, **WAN Channel Config**, **VLAN Channel Config**, **WAN Setting**, **WAN Status**, **DNS**, **DDNS**, and **OAM Configuration**. A screen is displayed as shown in [Figure 4.6](#).

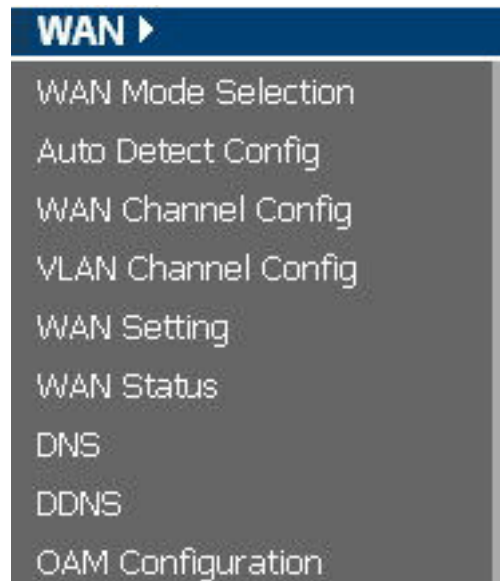

**Figure 4.6 WAN options**

### 4.6.1 WAN Mode Selection

To configure the WAN Mode Setting, click the **WAN Mode Selection (WAN > WAN Mode Selection)** on the left navigation bar. A screen is displayed as shown in [Figure 4.6.1](#)

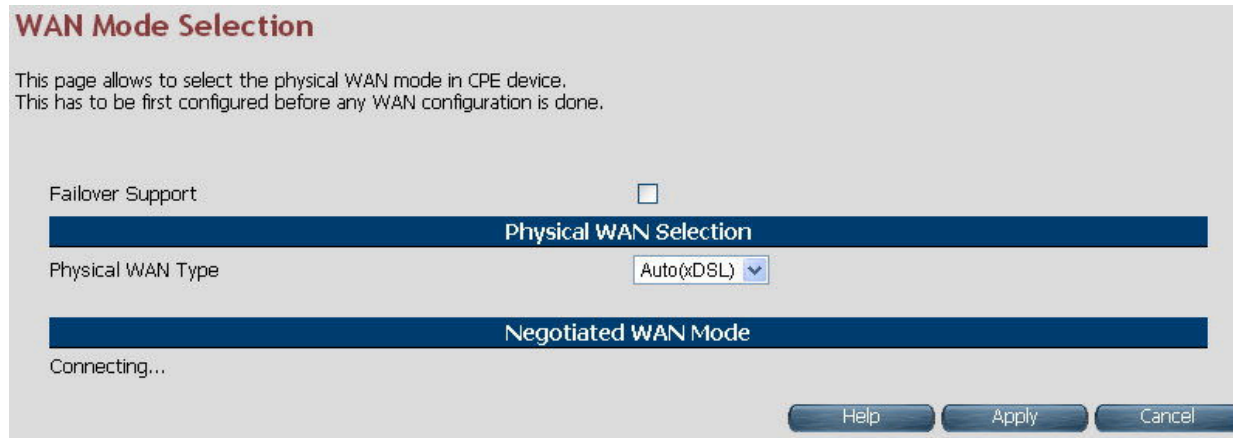

**Figure 4.6.1 WAN Mode Setting(Seleted Auto)**

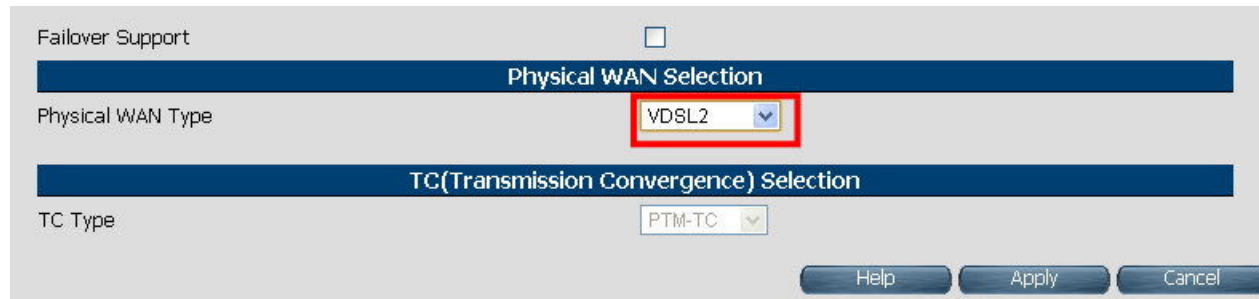

**Figure 4.6.1.1 WAN Mode Setting(Seleted ADSL2+ / VDSL2)**

The screen contains the following details:

**Fields in WAN Mode Setting:**

Field	Description
Failover Support	Select this checkbox to enable Dual WAN support.
<b>Primary WAN Selection</b>	
Physical WAN Type	Choose the WAN type from the drop down list. For multi-WAN mode supported CPE image the dropdown will present following options - ADSL2+, VDSL2, xDSL (Auto), WAN Ethernet over MII-0, WAN Ethernet over MII-1, 3G WAN and LTE WAN.
<b>TC (Transmission Convergence) Selection</b>	
TC Type	Choose the Transmission Convergence from the drop down list - 1). ATM-TC or 2).PTM-TC or 3). Auto. This field is displayed, only if ADSL2+ or xDSL is chosen as the WAN type.

When you enable the **Failover Support** in the WAN Mode Selection page, a screen is displayed as shown in [Figure 4.6.1.2](#)

### 4.6.2 Auto Detect Setting

Auto detect feature is a fully automatic way to find and configure VC channel or VLAN channel for active WAN PHY of the device and WAN protocol for the same (either PPPoE/DHCP).

User has to provide pool of VC channels or VLAN channels which will be probed one by one sequentially and upon successful detection of a channel, WAN protocol probing will be done and configured in the device.

To configure the **Auto Detect Config**, click **Auto Detect Config (WAN > Auto Detect Config)** on the left navigation bar. A screen is displayed as shown in [Figure 4.6.2](#)

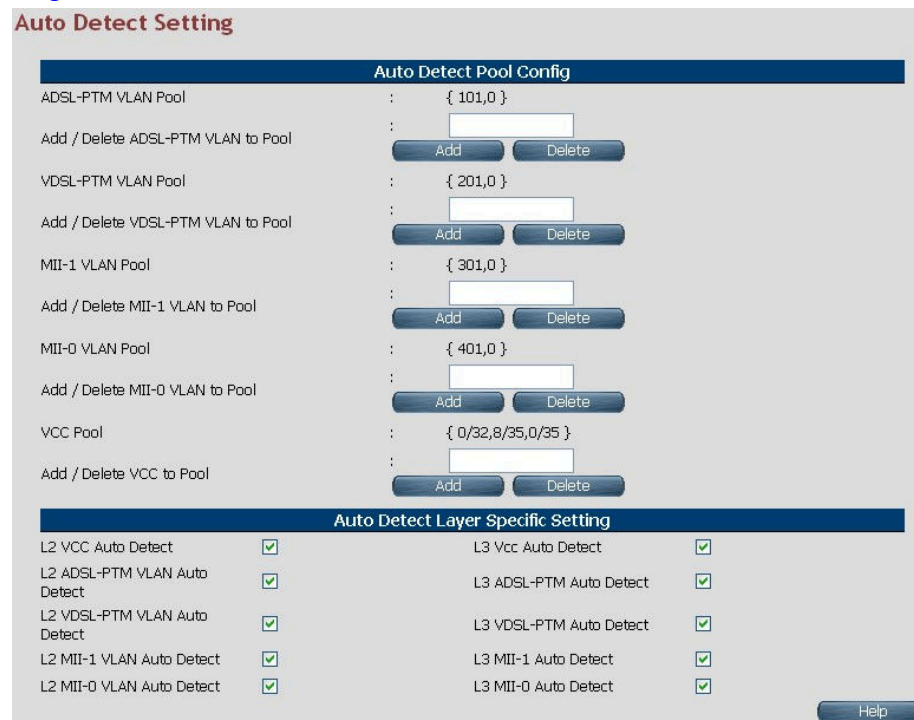

**Figure 4.6.2 Port Mapping Configuration**

The screen contains the following details:

**Fields in Auto detect Config:**

Field	Description
ADSL-PTM VLAN Pool	This displays the current configured VLAN pool for autodetect in ADSL-PTM WAN mode.
Add/Delete ADSL-PTM VLAN to Pool	Add or delete VLAN to ADSL-PTM VLAN pool.
VDSL-PTM VLAN Pool	This displays the current configured VLAN pool for autodetect in VDSL-PTM WAN mode.
Add/Delete VDSL-PTM VLAN to Pool	Add or delete VLAN to VDSL-PTM VLAN pool.
MII-1 VLAN Pool	This displays the current configured VLAN pool for autodetect in MII-1 WAN mode.
Add/Delete MII-1 VLAN to Pool	Add or delete VLAN to MII-1 VLAN pool.
MII-0 VLAN Pool	This displays the current configured VLAN pool for auto-detect in MII-0 WAN mode.
Add/Delete MII-0 VLAN to Pool	Add or delete VLAN to MII-0 VLAN pool.
VCC Pool	This displays the current configured VCC pool for auto-detect in ADSL-ATM WAN mode.
Add/Delete VC to Pool	Add or delete VCC to ADSL-ATM VCC pool.
L2 VCC Auto Detect	Select this to enable VCC auto detection from the specified pool for ADSL-ATM WAN mode
L2 ADSL - PTM VLAN Auto Detect	Select this to enable VLAN auto detection from the specified pool for ADSL - PTM WAN mode.
L2 VDSL - PTM VLAN Auto Detect	Select this to enable VLAN auto detection from the specified pool for VDSL - PTM WAN mode.



**Fields in Auto detect Config(cont'd):**

<b>Field</b>	<b>Description</b>
L2 MII-1 VLAN Auto Detect	Select this to enable VLAN auto detection from the specified pool for MII-1 WAN mode.
L2 MII-0 VLAN Auto Detect	Select this to enable VLAN auto detection from the specified pool for MII-0 WAN mode.
L3 VCC Auto Detect	Select this to enable WAN auto detection (in sequence of PPPoE/DHCP) in ADSL-ATM WAN mode.
L3 ADSL - PTM VLAN Auto Detect	Select this to enable WAN auto detection (in sequence of PPPoE/DHCP) in ADSL-PTM WAN mode.
L3 VDSL - PTM VLAN Auto Detect	Select this to enable WAN auto detection (in sequence of PPPoE/DHCP) in VDSL-PTM WAN mode.
L3 MII-1 VLAN Auto Detect	Select this to enable WAN auto detection (in sequence of PPPoE/DHCP) in MII-1 WAN mode.
L3 MII-0 VLAN Auto Detect	Select this to enable WAN auto detection (in sequence of PPPoE/DHCP) in MII-0 WAN mode.

### 4.6.3 WAN Channel Config

To configure the **WAN Channel Config**, click the **WAN Channel Config (WAN > WAN Channel Config)** on the left navigation bar. A screen is displayed as shown in [Figure 4.6.3](#).

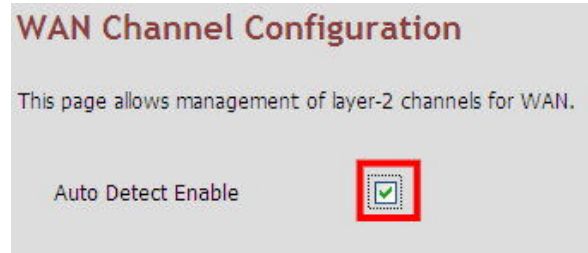

**Figure 4.6.3**

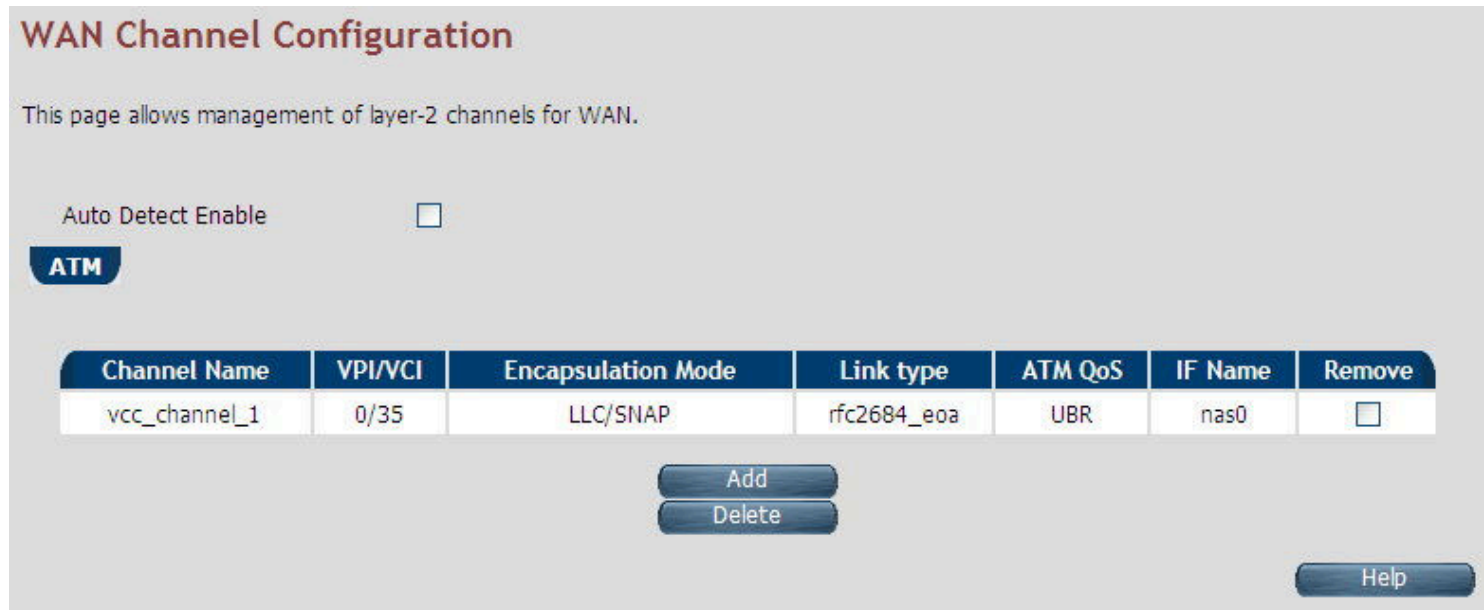

**Figure 4.6.3.1 WAN Channel Config (Auto Detecting does not check the checkbox)**

The screen contains the following details:

**Fields in WAN Channel Config:**

Field	Description
<b>ATM</b>	The ATM based WAN channels are configured through the ATM tab.
Auto Detect Enable	To enable Auto Detect.
Channel Name	User specified VCC Name.
VPI/VCI	Virtual Path Identifier and Virtual Channel Identifier.
Encapsulation Mode	Encapsulation Mode for this VCC from dropdown - LLC/SNAP or VCMux mode.
Link type	Shows AAL5 Link type for ATM VCC (values such as EoATM, IPoATM, PPPoATM).
ATM QoS	Quality of Service for ATM VCC
IF Name	ATM Channel interface name in system.
Remove	Select this option to delete an ATM channel.

When you click **Add** inside the WAN Channel-ATM tab, a screen is displayed as shown in [Figure 4.6.3.2](#)

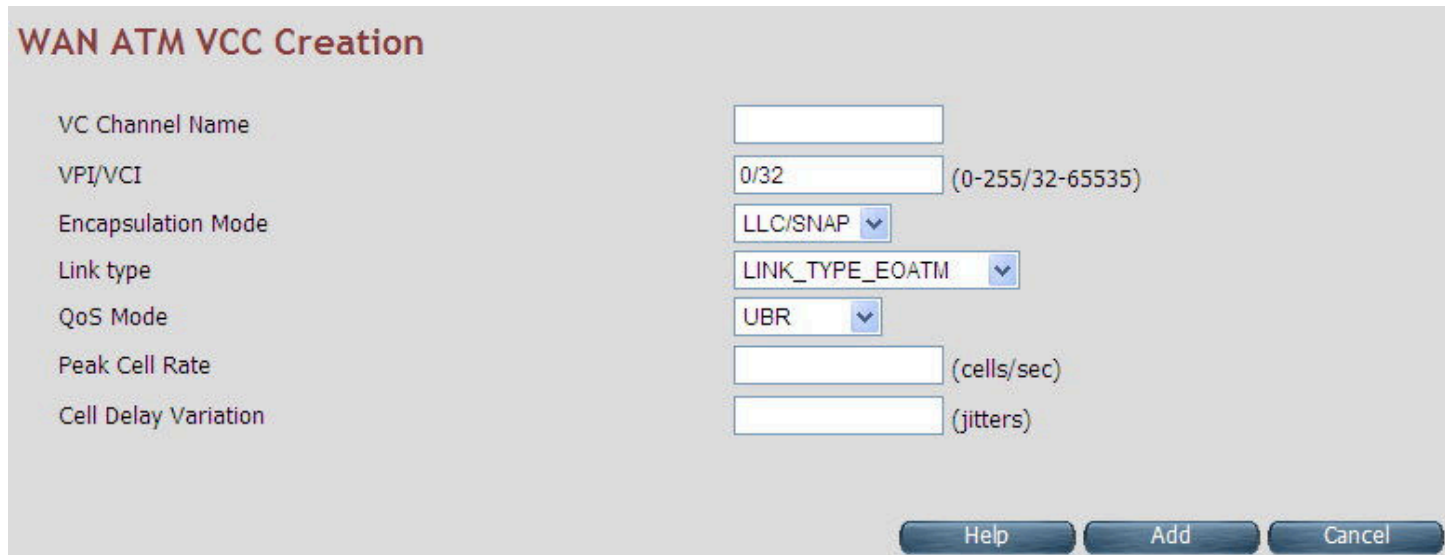

The image shows a configuration window titled "WAN ATM VCC Creation". It contains several fields and dropdown menus for configuring an ATM VCC. The fields are: VC Channel Name (empty), VPI/VCI (0/32, with a range of 0-255/32-65535), Encapsulation Mode (LLC/SNAP), Link type (LINK\_TYPE\_EOATM), QoS Mode (UBR), Peak Cell Rate (empty, with units cells/sec), and Cell Delay Variation (empty, with units jitters). At the bottom right, there are three buttons: Help, Add, and Cancel.

VC Channel Name	<input type="text"/>
VPI/VCI	<input type="text" value="0/32"/> (0-255/32-65535)
Encapsulation Mode	LLC/SNAP
Link type	LINK_TYPE_EOATM
QoS Mode	UBR
Peak Cell Rate	<input type="text"/> (cells/sec)
Cell Delay Variation	<input type="text"/> (jitters)

Buttons: Help, Add, Cancel

**Figure 4.6.3.2 WAN Channel Config - ATM VCC Creation**

The screen contains the following details:

**Fields in WAN Channel Config:**

Field	Description
VC Channel Name	User specified VCC Name.
VCI/VPI	Virtual Path Identifier and Virtual Channel Identifier
Encapsulation Mode	Encapsulation Mode for this VCC from dropdown - LLC/SNAP or VCMux mode.
Link type	Select AAL5 Link type for ATM VCC (possible values such as EoATM, IPoATM, PPPoATM).
QoS Mode	Quality of Service for ATM VCC. Available options are <b>UBR</b> , <b>CBR</b> , <b>rt-VBR</b> , <b>nrt-VBR</b> and <b>UBR+</b> .
Peak Cell Rate	Peak Cell Rate specified in cells/second.
Cell Delay Variation	Cell Delay Variation specified in terms of jitters.

- ◆ Click **Add** to save the information that you have entered.
- ◆ Click **Cancel** to exit from this page without saving the changes.

### 4.6.4 VLAN Channel config

To configure the **VLAN Channel Config**, click the **VLAN Channel Config (WAN > VLAN Channel Config)** on the left navigation bar. A screen is displayed as shown in [Figure 4.6.4](#).

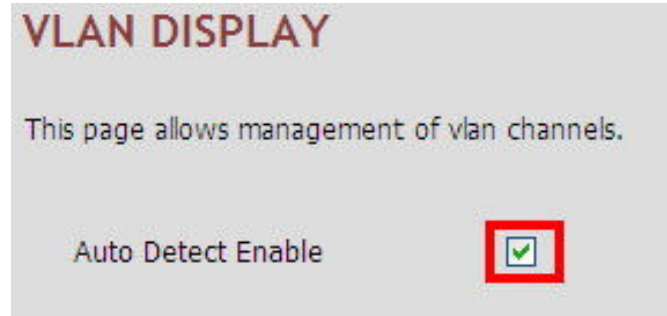

**Figure 4.6.4**



**Figure 4.6.4.1 VLAN Channel Config Display(Auto Detecting does not check the checkbox)**

The screen contains the following details:

**Fields in VLAN Display:**

Field	Description
Auto Detect Enable	To enable Auto Detect.
VLAN Name	User specified VLAN Channel name.
Base WAN Name	Displays the L2 interface names over which VLAN Channel has been configured.
VLAN id	VLAN identifier in range of 1- 4095.
IF Name	VLAN interface name.
MAC Address	MAC address of VLAN interface name.
Select	Select this option to delete a specific VLAN channel.

- ◆ Click **Add** to save the information that you have entered.
- ◆ Click **Cancel** to exit from this page without saving the changes.

When you click **Add** button inside the VLAN Channel Config page, a screen is displayed as shown in [Figure 4.6.4.2](#)

**Figure 4.6.4.2 VLAN Channel Config - Add**

The screen contains the following details:

**Fields in VLAN Creation:**

Field	Description
VLAN Channel Name	User specified VLAN Channel name.
Mode Name	List of L2 interfaces over which VLAN Channels can be configured.
VLAN Id	VLAN identifier in range of (7 - 4095). VLAN Identifiers(1 - 6) are internally used in system for special purpose and are not available to user for configuration.
Override MAC Address	This is an option to configure MAC address by overriding physical MAC address. In the current release, this option is not available to user for configuration.

- ◆ Click **Add** to save the information that you have entered.
- ◆ Click **Cancel** to exit from this page without saving the changes.



### 4.6.5 WAN Setting

To configure the WAN interface, click the **WAN Setting** link (**WAN > WAN Setting**) on the left navigation bar and a screen is displayed as shown in [Figure 4.6.5](#).

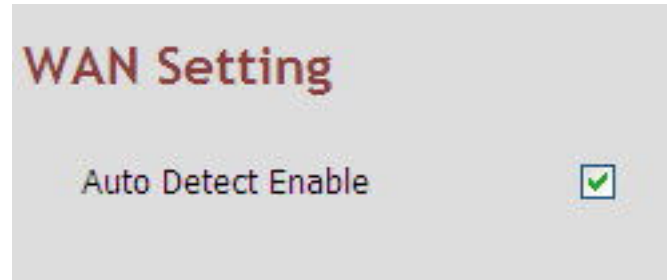

**Figure 4.6.5 WAN Setting - Auto Detect Enable**



**Figure 4.6.5.1 WAN Setting**

The NV-600AI can support up to maximum 16 WAN connections in system. When a hardware based QoS is enabled in system, it limits the number of VCCs to 8 only for ATM based WAN. For creating a new WAN connection, click **Add** in the WAN setting page. Please follow the rest of the steps for creating the WAN connection.

The last column named DEFAULT GATEWAY allows to select the WAN for relevant WAN mode setting in WAN setting web page. When the user clicks any of the radio button, he will be asked to confirm the same. If the user clicks **OK**, the default gateway will be configured on the selected WAN connection, otherwise the changes will not be applied.

The screen contains the following details:

**Fields in WAN Settings:**

Field	Description
Auto Detect Enable	To enable Auto Detect.
WAN Number	The configured WAN are referred through auto-assigned names in form WANIP<No.> or WANPPP<No.> where <No.> start from 0.
WAN Channel	Provides information of layer-2 WAN channel configured.
Type	Provides information about type of WAN such as PPPoE or DHCP or Bridged etc.
Default VoIP Interface	This option is present in only IAD models, where VoIP is supported. this is default interface for VoIP packets.
Default Gateway	This option allows to configure default route in system. The chosen WAN will be used for default route.

When you click **Add / Modify** button in WAN Settings web page, a screen is displayed as shown in [Figure 4.6.5.2](#)



**Figure 4.6.5.2 WAN Settings – Apply – Step1**

The screen contains the following details:

**Fields in WAN Settings – Apply – Step1:**

Field	Description
Attached Channel	Select the WAN Channel (e.g. PVC) from drop-down, being configured as WAN.
Dynamic IP Address	To get your IP Address from your service provider (means NV-600AI is DHCP client on WAN) click <b>Apply</b> .
Static IP Address	To enter the WAN interface IP Address of NV-600AI enable this field and click <b>Apply</b> .
PPPoE	Point-to-Point Protocol over Ethernet used for connecting to the ISP, click <b>Apply</b> .
PPPoA	Point-to-Point Protocol over ATM used for connecting to the ISP, click <b>Apply</b> . This setting is applicable only for ATM WAN mode.
Bridge	To configure the WAN of bridged type, select this field and click <b>Apply</b> .

- ◆ Click **Apply** at any time during configuration to save the information that you have entered.
- ◆ Click **Cancel** to exit from this page without saving the changes.

### 4.6.5.1 Dynamic IP Address

To configure the WAN interface of DHCP IP type, select **Dynamic IP Address** option. A screen is displayed as shown in [Figure 4.6.5.3](#)

The screenshot shows the WAN configuration page. At the top, it says "WAN" and "The CPE device can be connected to your service provider in any of the following ways". Below this, there are two dropdown menus: "Attached Channel" set to "1\_ptm0.201" and "WAN TYPE" set to "Dynamic IP Address". Under "Address Version", there are two checkboxes: "IPv4" (checked) and "IPv6" (checked, highlighted with a red box). Below this is a section titled "WAN IPv6 Configuration" which is also outlined with a red box. It contains several fields: "Configuration Modes" (Stateful DHCPv6 (IA\_NA and IA\_PD)), "DUID Type" (Type-1: LLT (Link Layer Time)), "IANA ID" (0), "IAPD ID" (0), "SLA ID" (0), "Rapid-Commit" (unchecked), and "Default WAN" (unchecked). At the bottom right of the form are three buttons: "Help", "Apply", and "Cancel".

**Figure 4.6.5.3 Dynamic IP Address**

Please Enable IPv6 to set the WAN IPv6 Configuration. Select IPv6 Setting(IPv6 > IPv6 setting) on the left navigation bar.

### 4.6.5.2 Static IP Address

To configure the WAN interface to use a static IP address, select the option **Static IP Address** in the **WAN Settings** screen. A screen is displayed as shown in [Figure 4.6.5.4](#)

**WAN**

The CPE device can be connected to your service provider in any of the following ways

Attached Channel: 1\_ptm0.201

WAN TYPE: Static IP Address

Address Version:  IPv4  IPv6

IP address assigned by your ISP: [ ][ ][ ][ ]

Subnet Mask: [ ][ ][ ][ ]

ISP Gateway Address: [ ][ ][ ][ ]

**IPv6**

IPv6 address assigned by your ISP: [ ][ ][ ][ ][ ][ ][ ][ ]

Prefix Length: [ ][ ]

IPv6 Gateway Address: [ ][ ][ ][ ][ ][ ][ ][ ]

Lan Prefix: [ ][ ][ ][ ][ ][ ][ ][ ]

**IPv6 DNS Servers**

IPv6 Primary DNS Server address: [ ][ ][ ][ ][ ][ ][ ][ ]

IPv6 Secondary DNS Server address: [ ][ ][ ][ ][ ][ ][ ][ ]

Default WAN:

Help Apply Cancel

**Figure 4.6.5.4 WAN Static IP**

The screen contains the following details:

**Fields in Static IP:**

Field	Description
<b>Address Version</b>	
IP address assigned by your ISP	To specify the IP Address of NV-600AI CPE's WAN link.
Subnet Mask	To specify the Subnet Mask of NV-600AI CPE's WAN link.
ISP Gateway Address	To specify the Gateway address of the NV-600AI CPE's WAN.
<b>IPv6</b>	
IPv6 address assigned by your ISP	This is the static IP address for the WAN interface.
Prefix Length	This is the prefix length of the IPv6 address.
IPv6 Gateway Address	This is the default gateway.
LAN Prefix	This is the prefix used to auto-configure LAN side hosts.
<b>IPv6 DNS Servers</b>	
IPv6 Primary DNS Server Address	This is the primary DNS server.
IPv6 Secondary DNS Server Address	This is the secondary DNS server.
Default WAN	This option allows to configure default route for relevant WAN mode of this WAN connection.

- ◆ Click **Apply** at any time during configuration to save the information that you have entered.
- ◆ Click **Cancel** to exit from this page without saving the changes.

### 4.6.5.3 PPPoE

To configure the WAN interface to use PPPoE, choose the option **PPPoE**. A screen is displayed as shown in [Figure 4.6.5.5](#)

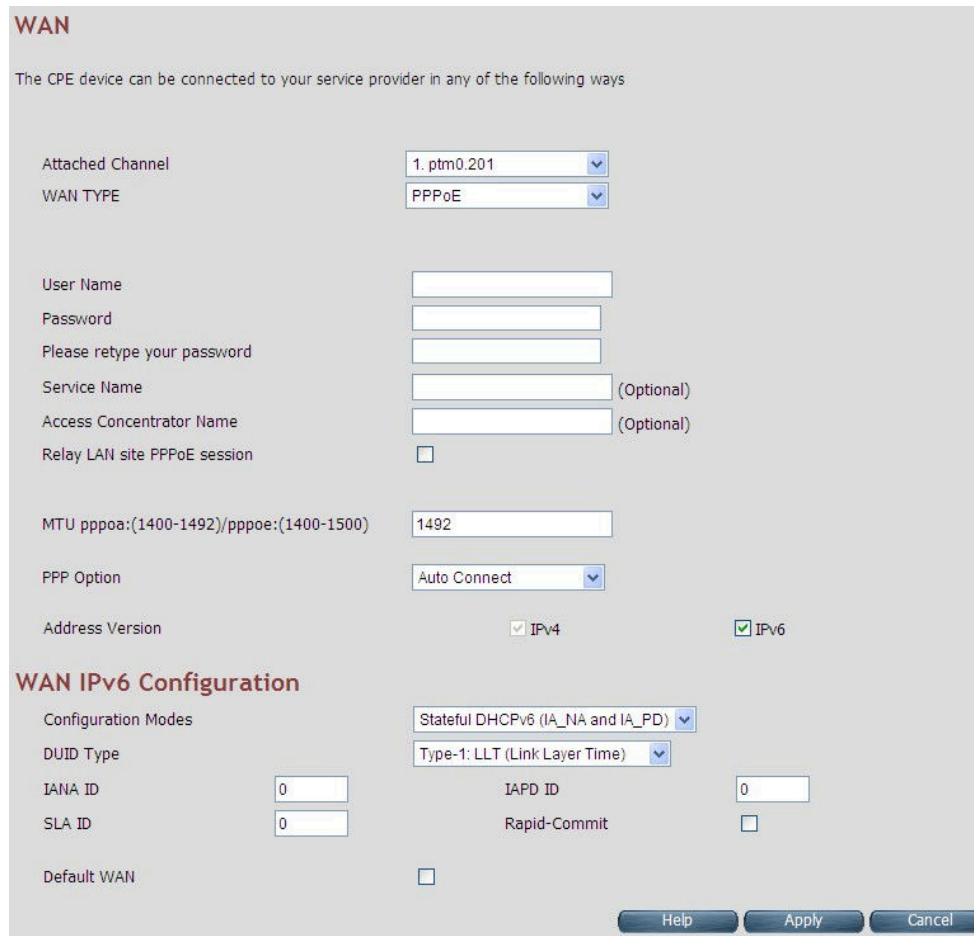

**WAN**

The CPE device can be connected to your service provider in any of the following ways

Attached Channel: 1. ptm0.201

WAN TYPE: PPPoE

User Name:

Password:

Please retype your password:

Service Name:  (Optional)

Access Concentrator Name:  (Optional)

Relay LAN site PPPoE session:

MTU pppoa:(1400-1492)/pppoe:(1400-1500): 1492

PPP Option: Auto Connect

Address Version:  IPv4  IPv6

**WAN IPv6 Configuration**

Configuration Modes: Stateful DHCPv6 (IA\_NA and IA\_PD)

DUID Type: Type-1: LLT (Link Layer Time)

IANA ID:  IAPD ID:

SLA ID:  Rapid-Commit:

Default WAN:

Buttons: Help, Apply, Cancel

**Figure 4.6.5.5 WAN PPPoE creation**

The screen contains the following details:

**Fields in PPPoE WAN:**

Field	Description
User Name	To enter a username for PPPoE session used for authentication in B-RAS.
Password	To enter a password for PPPoE session used for authentication in B-RAS.
Please retype your password	To enter the same password again to reconfirm.
Service Name	PPP Service Name (optional).
Access Concentrator Name	PPP Access concentrator Name (optional).
Relay LAN site PPPoE Session	This feature allows to enable/disable a PPPoE relay session. PPPoE relay also called PPPoE Passthrough.
PPP Option	Choose the option form the drop down list. The available options are, Auto Connect, Dial-On-Demand and Manual Connect.
Address Version	This option allows configurability of IPv4 and/or IPv6 stack on per WAN interface.



**Fields in PPPoE WAN (WAN IPv6 Configuration):**

Field	Description
Configuration Modes	This option allows to select following modes of IPv6 configuration: <ul style="list-style-type: none"> <li>◆ Stateful DHCPv6(IA_NA and IA_PD)</li> <li>◆ SLAAC (Address Configuration) with DHCPv6 (IA_PD)</li> </ul>
DUID Type	This option allows to configure different DUID (DHCP Unique Identifier) types: <ul style="list-style-type: none"> <li>◆ "Type-1: LLT (Link Layer Time)</li> <li>◆ "Type-2: EN (Enterprise Number)</li> <li>◆ "Type-3: LL (Link Layer)</li> </ul>
IANA ID	IANA option represents IPv6 address and parameters related to the same being accepted by DHCPv6 clients. IANA is the Identity Association for Non- Temporary Addresses option. This Identifier to be configured when Stateful DHCPv6 configuration mode is selected.
IAPD ID	IAPD options represent one or more IPv6 prefix and parameters related to it. IAPD is the Identity Association for Prefix Delegation. This identifier to be configured in both Stateful DHCPv6 or SLAAC+DHCPv6 configuration modes.
SLA ID	This parameter is called Site Level Aggregation Identifier. This identifier is used to configure the subnet for DHCPv6 client configuration.
Rapid-commit	This declaration enables DHCPv6-client to request the DHCPv-server to perform a Rapid Commit. Handshaking will happen with two DHCPv6 messages.
Default WAN	This option allows to configure default route for relevant WAN mode of this WAN connection.

- ◆ Click **Apply** at any time during configuration to save the information that you have entered.
- ◆ Click **Cancel** to exit from this page without saving the changes.

### 4.6.5.4 PPPoA

The PPP-over-ATM (PPPoA) mode is valid **only for ATM based** WAN. To configure the WAN interface to use PPPoA, select the **PPPoA** option. A screen is displayed as shown in [Figure 4.6.5.6](#)

**WAN**

The CPE device can be connected to your service provider in any of the following ways

Attached Channel: 5 VCC : pppatm1  
 WAN TYPE: PPPoA

User Name:   
 Password:   
 Please retype your password:

MTU pppoa:(1400-1492)/pppoe:(1400-1500): 1492  
 PPP Option: Auto Connect

Address Version:  IPv4  IPv6

**WAN IPv6 Configuration**

Configuration Modes: Stateful DHCPv6 (IA\_NA and IA\_PD)  
 DUID Type: Type-1: LLT (Link Layer Time)  
 IANA ID: 0 IAPD ID: 0  
 SLA ID: 0 Rapid-Commit:

Default WAN:

Help Apply Cancel

**Figure 4.6.5.6 WAN PPPoA creation**

The screen contains the following details:

**Fields in PPPoA WAN:**

Field	Description
User Name	To enter the username to be used in the PPPoA session.
Password	To enter the corresponding password for the specified username.
Please retype your password	To enter the password again to reconfirm.
Dial on Demand	This feature allows to automatically re-connect to the service provider once the connection was lost. The checkbox can be enabled or disabled for this feature.
Maximum Idle Time	Specifies how long the connection may remain idle before the PPPoA connection gets automatically disconnected. The Idle Timeout is specified in seconds.
Address Version	For PPPoA, the only supported IP addressing is IPv4 currently. The IPv6 for PPPoA is not available in this version of NV-600AI.

**Fields in PPPoA WAN IPv6 Configuration:**

Field	Description
Configuration Modes	<p>This option allows to select following modes of IPv6 configuration:</p> <ul style="list-style-type: none"> <li>◆ Stateful DHCPv6(IA_NA and IA_PD)</li> <li>◆ SLAAC (Address Configuration) with DHCPv6 (IA_PD)</li> </ul>
DUID Type	<p>This option allows to configure different DUID (DHCP Unique Identifier) types:</p> <ul style="list-style-type: none"> <li>◆ "Type-1: LLT (Link Layer Time)</li> <li>◆ "Type-2: EN (Enterprise Number)</li> <li>◆ "Type-3: LL (Link Layer)</li> </ul>
IANA ID	<p>IANA option represents IPv6 address and parameters related to the same being accepted by DHCPv6 clients. IANA is the Identity Association for Non- Temporary Addresses option. This Identifier to be configured when Stateful DHCPv6 configuration mode is selected.</p>
IAPD ID	<p>IAPD options represent one or more IPv6 prefix and parameters related to it. IAPD is the Identity Association for Prefix Delegation. This identifier to be configured in both Stateful DHCPv6 or SLAAC+DHCPv6 configuration modes.</p>
SLA ID	<p>This parameter is called Site Level Aggregation Identifier. This identifier is used to configure the subnet for DHCPv6 client configuration.</p>
Rapid-commit	<p>This declaration enables DHCPv6-client to request the DHCPv-server to perform a Rapid Commit. Handshaking will happen with two DHCPv6 messages.</p>
Default WAN	<p>This option allows to configure default route for relevant WAN mode of this WAN connection.</p>

- ◆ Click **Apply** at any time during configuration to save the information that you have entered.

- ◆ Click **Cancel** to exit from this page without saving the changes.

#### 4.6.5.5 Bridge

The option **Bridge** enables the bridge mode, which is a common connection method used for xDSL modem. Select this option on WAN Settings page and click Next. A screen is displayed as shown in [Figure 4.6.5.7](#)

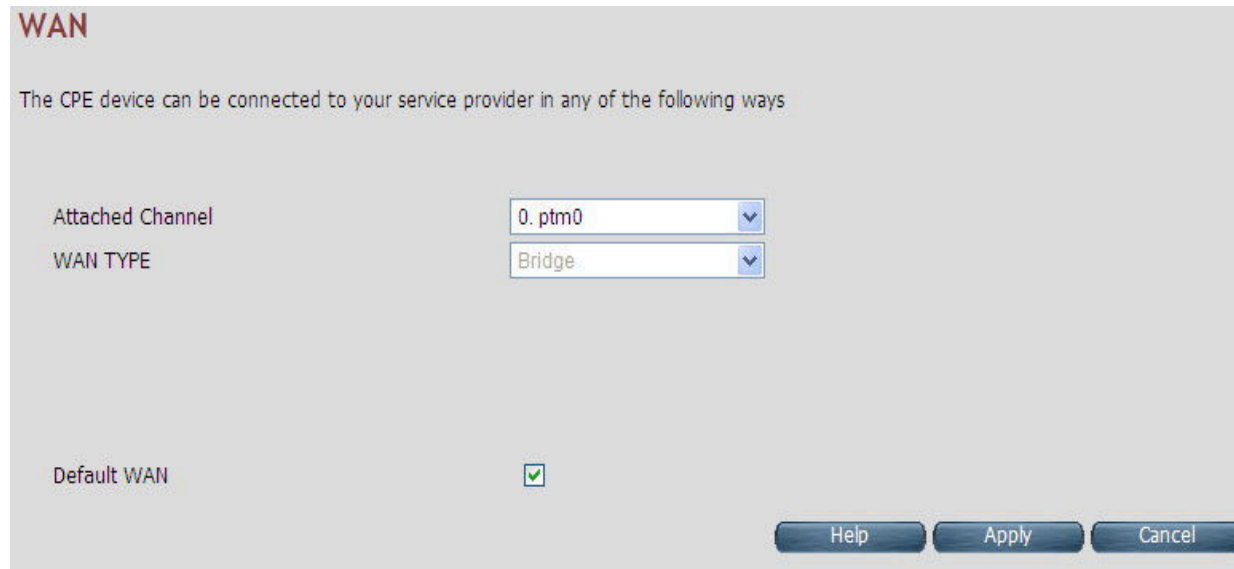

The screenshot shows the WAN configuration interface. At the top, the title "WAN" is displayed. Below it, a message states: "The CPE device can be connected to your service provider in any of the following ways". There are two dropdown menus: "Attached Channel" is set to "0. ptm0" and "WAN TYPE" is set to "Bridge". At the bottom left, there is a checkbox labeled "Default WAN" which is checked. At the bottom right, there are three buttons: "Help", "Apply", and "Cancel".

**Figure 4.6.5.7 Bridge WAN Setting**

The screen contains the following details:

**Fields in Bridge Configuration:**

Field	Description
Default WAN	This option allows to configure default route for relevant WAN mode of this WAN connection.

- ◆ Click **Apply** at any time during configuration to save the information that you have entered.
- ◆ Click **Cancel** to exit from this page without saving the changes.

#### **4.6.5.6 Delete**

This option allows to delete the selected configured WAN connection. This makes WAN connections free to re-choose the type of protocol and other parameters configuration.

- ◆ Click **Cancel** to exit from this page without saving the changes.
- ◆ Click **Apply** for deleting the WAN connection.

### 4.6.6 WAN Status

To display the status report of VCCs, click the **WAN Status** link (**WAN > WAN Status**) on the left navigation bar. A screen is displayed as shown in [Figure 4.6.6](#)

**WAN Status**

IPv4 IPv6

No	WAN Channel	Connection Type	Status	IP	Netmask	Connection Name	
1	PTM : VLAN - 201	PPPoE	UNCONFIGURED	Unconfigured	Unconfigured	WANPPP1	Connect

**Gateway Information**

**DNS Information**

Primary

Secondary

Help

**Figure 4.6.6 WAN Status**

The screen contains the following details:

**Fields in WAN Status:**

Field	Description
IPv4/IPv6	Choose the appropriate tab to view the status.
WAN Channel	For the currently configured WAN interface, this gives the layer-2 WAN channel information (such as ATM VCC).
Connection Type	The type of the connection mode in which NV-600AI is configured.
Status	Displays the connection status of the WAN.
IP	Displays the IP address in use.
Netmask	Displays the netmask in use.
Configured Connection Name	Displays the configured connection name.
Gateway Information	Provides information about the gateway.
DNS Information	Provides information about the primary and secondary DNS.

The control buttons shown against few WAN are explained below.



**Fields in Control Fields displayed in WAN Status Screen:**

Field	Description
Connect	This button appears only for PPPoA and PPPoE type of WAN links. On clicking this button, it tries to establish PPP link.
Disconnect	This button too appears only for PPPoA and PPPoE type of WAN links. On clicking this button, it brings down the PPP link.
Renew	This button appears only for DHCP type of WAN links. On clicking this button, it tries to establish renew the current lease.
Release	This button appears only for DHCP type of WAN links. On clicking this button, it tries to release the current lease.

When you click on the IPv6 tab in the WAN Status page, a screen is displayed as shown in [Figure 4.6.6.1](#)

**WAN Status**

IPv4 **IPv6**

No	WAN Channel	Connection Type	Status	IP	Configured Connection Name	
1	PTM : VLAN - 201	PPPoE	UNCONFIGURED	UNCONFIGURED	WANPPP1	Connect

**Gateway Information**

**DNS Information**

Primary	
Secondary	

Help

**Figure 4.6.6.1 WAN Status IPv6 Tab**

The screen contains the details as described in table of “**Fields in WAN Status**”.

### 4.6.7 DNS

To configure the Domain Name Server (DNS) address, click the **DNS** link (**WAN > DNS**) on the left navigation bar. A screen is displayed as shown in [Figure 4.6.7](#). For statically configured WAN, it is mandatory to configure DNS addresses through this page.

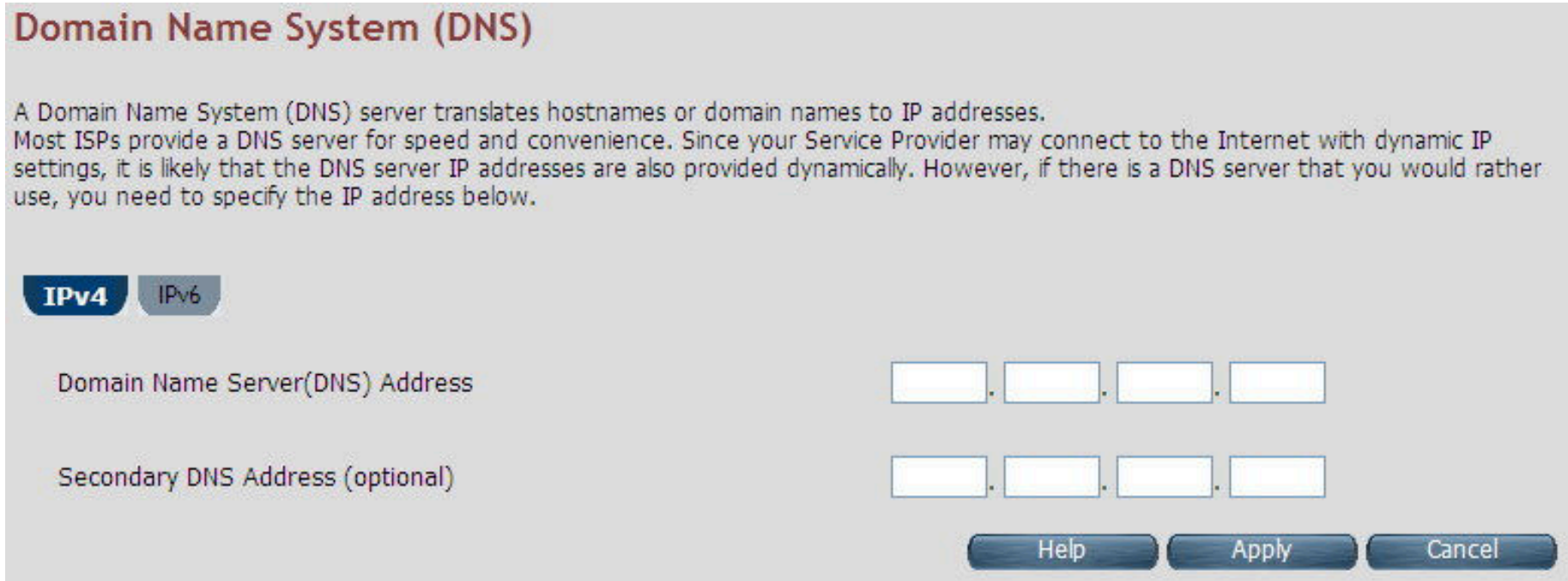

**Domain Name System (DNS)**

A Domain Name System (DNS) server translates hostnames or domain names to IP addresses. Most ISPs provide a DNS server for speed and convenience. Since your Service Provider may connect to the Internet with dynamic IP settings, it is likely that the DNS server IP addresses are also provided dynamically. However, if there is a DNS server that you would rather use, you need to specify the IP address below.

**IPv4** IPv6

Domain Name Server(DNS) Address  .  .  .

Secondary DNS Address (optional)  .  .  .

Help Apply Cancel

**Figure 4.6.7 DNS Configuration**

The screen contains the following details:

**Fields in DNS:**

Field	Description
IPv4/IPv6	Select the appropriate tab to configure IPv4 or IPv6. IPv6 support is currently not available for DNS configuration.
Domain Name Server (DNS) Address	Enter the DNS address of the primary DNS server.
Secondary DNS Address (optional)	Enter the address of the secondary DNS server, if available. It is an optional parameter.

- ◆ Click **Cancel** to exit from this page without saving the changes.
- ◆ Click **Apply** for deleting the WAN connection.

### 4.6.8 DDNS

The Dynamic DNS is useful for getting a FQDN URL registered for a dynamic IP address to a DNS service provider. The NV-600AI software integrates support for three Dynamic DNS service providers:

- dhs
- dyndns
- dyns

The user needs to register first with a chosen DNS Service provider. The registered information needs to be configured in DDNS settings web page. To configure thee registered information in DDNS settings page, click the **DDNS** link (**WAN > DDNS**) on the left navigation bar. A screen is displayed as shown in [Figure 4.6.8](#)

#### DDNS Settings

Dynamic DNS allows you to update your dynamic IP address with one or many dynamic DNS services. So anyone can access your FTP or Web service on your computer using DNS-like address.

Enable DDNS Support	<input type="checkbox"/>
WAN Interface	WANPPP1 <span style="font-size: small;">▼</span>

	DDNS Server	Host Name	User Name	Password
<input checked="" type="radio"/>	dhs	<input type="text"/> .dyn.dhs.org	<input type="text"/>	<input type="text"/>
<input type="radio"/>	dyndns	<input type="text"/> .dyndns.org	<input type="text"/>	<input type="text"/>
<input type="radio"/>	dyns	<input type="text"/> .dyns.cx	<input type="text"/>	<input type="text"/>

**Figure 4.6.8 DDNS Settings**

The screen contains the following details:

**Fields in DDNS:**

Field	Description
Enable DDNS support	Check box to enable DDNS support in CPE.
WAN Interface	WAN Interface name from dropdown for DDNS resolution. The DDNS agent running in CPE keeps track of changes in IP address of chosen WAN and informs DNS service provider.
DDNS Server	Dynamic DNS Server Provider.
Host Name	Host name registered with DDNS Service provider. This is part of FQDN used for accessing the host.
User Name	Registered user name with DDNS service provider.
Password	Registered password with DDNS service provider.

- ◆ Click **Apply** for applying the DDNS changes into system.
- ◆ Click **Cancel** to exit from this page without saving the changes.

### 4.6.9 OAM Configuration

This page provides ATM F5 based OAM test. Hence the settings are valid only for ATM based WAN. To configure the ADSL OAM settings, click the **OAM Configuration** link (**WAN > OAM Configuration**) on the left navigation bar. This release supports only F5 type of OAM tests as shown in [Figure 4.6.9](#)

#### ADSL OAM Configuration

OAM Setting Table

No	VPI/VCI	Loopback	Transmit Time	TX Cells	Update Entry
1	0/35	Disable	600	5	<input checked="" type="radio"/>
2	0/0	Disable	600	5	<input type="radio"/>

OAM Settings

Select Mode: OAM\_F5 ▼

VPI Channel:

VCI Channel:

Select Method:  PING

Loopback:  Enable

Transmit interval time:  [ 60 - 10000 ] Milliseconds

Number of Tx Cells:  [ 1 - 100 ]

**Figure 4.6.9 ADSL OAM F5 Test**

The screen contains the following details:

**Fields in ADSL OAM F5 Test page:**

Field	Description
OAM F5 Setting Table	<p>This table displays all active connections with following OAM parameters information:</p> <ul style="list-style-type: none"> <li>◆ No: Number</li> <li>◆ VPI: Virtual Path Identifier</li> <li>◆ VCI: Virtual Connection Identifier</li> <li>◆ Loopback: Enabled or Disabled</li> <li>◆ Transmit Time: actual value in milliseconds</li> <li>◆ Tx Cells: No of cells to be transmitted</li> <li>◆ Update Entry:</li> </ul>
<b>OAM Settings</b>	
Select Mode	OAM_F5
VPI Channel	Displays the selected VPI channel of the OAM F5 Setting Table.
VCI Channel	Displays the selected VCI channel of the OAM F5 Setting Table.
F5 Loopback	Used to enable/disable F5 Loopback.
F5 Transmit Interval time	Configures the time (in ms) for the interval to send F5 loopback cells.
Number of Tx cells	Count to total number of transmitted ATM cells.

- ◆ Click **Test** to view the OAM F5 results.



When you test the OAM Configuration, the F5 result is displayed as shown in [Figure 4.6.9.1](#) and this may be a failure or successful OAM F5 result.

**OAM F5 Ping Successful!**

VPI/VCI	0/35
Cells Tx	5
Cells Rx	5
Cells Not Rx	0
Max Resp Time	7
Min Resp Time	7
Avg Resp Time(millisecs)	7

**Figure 4.6.9.1 Test Successful**

**OAM F5 Ping Failed!**

VPI/VCI	0/35
Cells Tx	5
Cells Rx	0
Cells Not Rx	5
Max Resp Time	-1
Min Resp Time	0
Avg Resp Time(millisecs)	0

**Figure 4.6.9.2 Test Failed**

The screen contains the following details:

**Fields in ADSL OAM F5 Test Page:**

Field	Description
VPI/VCI	Displays the selected VPI/VCI channel of the OAM F5 Setting Table.
Cells Tx	Count of total number of transmitted ATM cells.
Cells Rx	Count of total number of received ATM cells.
Cells not Rx	Count of total number of not received ATM cells.
Max Resp Time	Displays the maximum response time in milliseconds.
Min Resp Time	Displays the minimum response time in milliseconds.
Avg Resp Time (milisecs)	Displays the average response time in milliseconds.

## 4.7 Select "LAN"

When connecting the NV-600AI to a new control PC, one may want to go through the following steps in order to make the IP address previously set by ifconfig in the console or on some later occasion, one may want to change it again without using the console, then the menu below will be helpful. In order to set the IP address, click on "LAN Settings". You can view **LAN** in the left navigation bar for LAN related settings.

Select the "LAN". The menu below includes the sub-menus of **LAN ARP List**, **LAN Settings**, **UPnP Devices**, **LAN Switch Port Setting**, **LAN Port Status**. A screen is displayed as shown in [Figure 4.7](#).

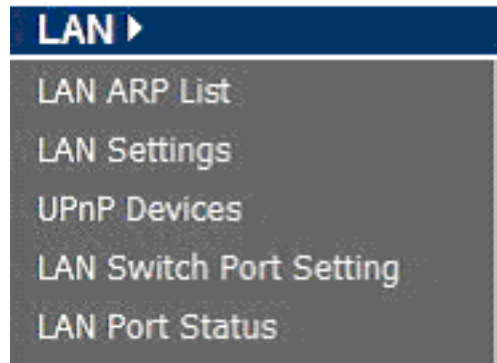

**Figure 4.7 LAN options**

### 4.7.1 LAN ARP List

To view the ARP entries list that is currently present in CPE, click the **LAN ARP List** link (**LAN > LAN ARP List**) on the left navigation bar. A screen is displayed as shown in [Figure 4.7.1](#)



**Figure 4.7.1 ARP List**

The screen contains the following details:

#### Fields in LAN ARP List:

Field	Description
MAC Address	MAC Address of next hop node from ARP entry.
IP Address	IP Address of node from ARP entry.
HW Type	Hardware Type for ARP entry. 0x1 corresponds to IEEE 802.3 ethernet based interface.

- ◆ Click **Perform ARP Scan** to ensure the ARP entries connected to the CPE.

### 4.7.2 LAN Settings

To configure the LAN interface, click the **LAN Settings** link (**LAN > LAN Settings**) on the left navigation bar. In case the Secondary level subnet Range checkbox is checked, some additional data and options will be on display. A screen is displayed (DHCP Server mode) as shown in [Figure 4.7.2](#).

The screenshot displays the 'LAN Settings' configuration page. At the top, there is a title 'LAN Settings' and a descriptive text: 'You can configure LAN settings of CPE device such as LAN IP Address and DHCP configuration.' Below this, there are two tabs: 'IPv4' (selected) and 'IPv6'. The main configuration area includes fields for 'IP Address' (192, 168, 16, 250), 'Subnet Mask' (255, 255, 255, 0), and 'MAC Address' (00, 05, 6e, 02, 00, 10). A section titled 'Secondary level subnet Range' contains a checked checkbox labeled 'Enable', a red-bordered box around the 'Secondary IP Address' (192, 168, 2, 1) and 'Secondary Subnet Mask' (255, 255, 255, 0) fields, and a 'DHCP Mode' dropdown menu set to 'Disable'. A red arrow points from the 'Enable' checkbox to the secondary IP address fields. At the bottom, there are 'IP Address Reservation' options with a 'Click Here' link, and three buttons: 'Help', 'Apply', and 'Cancel'.

**Figure 4.7.2 LAN Settings – DHCP Server**

The screen contains the following details:

**Fields in LAN Settings:**

Field	Description
IP Address	Used to enter the LAN interface IP Address of CPE device.
Subnet Mask	To enter the LAN Subnet Mask of CPE device.
MAC Address	MAC Address of LAN bridge device. It can be overridden by specifying the user supplied MAC address here.
Enable	To enable the secondary IP address on the LAN interface.
Secondary IP Address	This is to enter the secondary IP address.
Secondary Subnet Mask	This is to enter the secondary subnet mask.
DHCP Mode	To choose the mode of DHCP in NV-600AI. The options available are: Disable, Server and Relay Agent. The default value is <b>Disable</b> . If DHCP Mode is set to <b>Server</b> , there are some additional options available, which are shown in <b>Figure 4.7.2</b> . IP Pool Starting Address - To enter the starting IP Address of the DHCP server pool. IP Pool Ending Address - To enter the ending IP Address of the DHCP server pool. Lease Time - To specify the lease period for DHCP allocation. Local Domain Name (optional) - To enter the Domain Name of the DHCP server. DHCP Server IP - IP address of the DHCP server on the interface shown, to which the DHCP requests are relayed.

Field	Description
DHCP Server	DHCP Mode <span style="border: 2px solid red; padding: 2px;">Server</span>
	<b>DHCP Server</b>
	IP Pool Starting Address <input type="text" value="192"/> . <input type="text" value="168"/> . <input type="text" value="1"/> . <input type="text" value="2"/>
	IP Pool Ending Address <input type="text" value="192"/> . <input type="text" value="168"/> . <input type="text" value="1"/> . <input type="text" value="254"/>
	Lease Time <span style="border: 1px solid gray; padding: 2px;">Half hour</span>
Local Domain Name <input type="text" value="dslgw.lantiq.com"/> (optional)	
IP Pool Starting Address	DHCPv4 pool start IPv4 address.
IP Pool Ending Address	DHCPv4 pool end IPv4 address.
Lease Time	Lease Time for every DHCP leased entry. Select from dropdown of allowed values.
Local Domain Name	Local domain name configured to LAN hosts by DHCPv4 server.

- ◆ Click APPLY at any time during configuration to save the information that you have entered.
- ◆ Click CANCEL to exit from this page without saving the changes.

When you click the **Click Here** link under IP Address Reservation in the LAN Settings page, a screen is displayed as shown in [Figure 4.7.2.1](#) This is used for the reservation of IP address of client's MAC address in DHCP server.

**IP Reservation**

IP reservation Allow static IP address assignment by DHCP server for specified MAC address

HOST NAME	IP ADDRESS	MAC ADDRESS	ENABLE	
unknown	<input type="text"/> . <input type="text"/> . <input type="text"/> . <input type="text"/> <input type="text"/>	<input type="text"/> : <input type="text"/> : <input type="text"/> : <input type="text"/> : <input type="text"/> <input type="text"/> : <input type="text"/>	<input type="checkbox"/>	<input type="button" value="Add"/>

**Figure 4.7.2.1 IP Reservation**



The screen contains the following details:

**Fields in LAN Settings:**

Field	Description
Host Name	Host Computer name.
IP Address	IP Address to be statistically reserved for this host identified by MAC address.
MAC Address	MAC address of Host computer for which static IP reservation is needed.
Enable	To enable this static IP reservation entry.
Add	To add this IP reservation entry.

- ◆ Click APPLY to save the changes that you have entered.
- ◆ Click CANCEL to exit from this page without saving the changes.

The following pages describe the LAN Settings for IPv6:

**LAN Settings - IPv6 Tab**

If IPv6 functionality is enabled through (**Advanced Setup > IPv6**), then LAN Settings web page also presents IPv6 tab. Based on the **Auto Configuration Mode**, the following screens are displayed as shown in [Figure 4.7.2.2](#), [Figure 4.7.2.3](#) and [Figure 4.7.2.4](#).

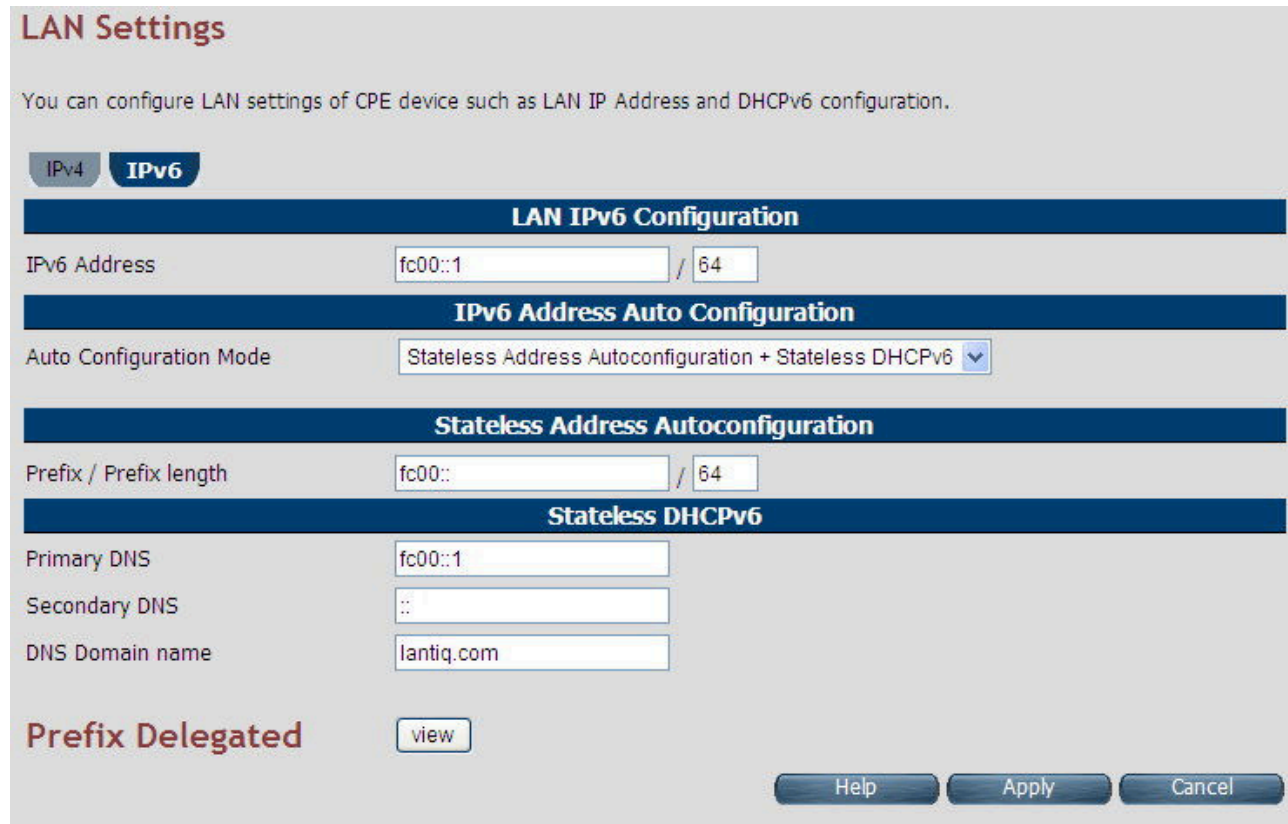

**LAN Settings**

You can configure LAN settings of CPE device such as LAN IP Address and DHCPv6 configuration.

IPv4 **IPv6**

**LAN IPv6 Configuration**

IPv6 Address  /

**IPv6 Address Auto Configuration**

Auto Configuration Mode

**Stateless Address Autoconfiguration**

Prefix / Prefix length  /

**Stateless DHCPv6**

Primary DNS

Secondary DNS

DNS Domain name

**Prefix Delegated**

**Figure 4.7.2.2 LAN Settings - IPv6 Tab (Option 1: SLAAC + Stateless DHCPv6)**

**LAN Settings**

You can configure LAN settings of CPE device such as LAN IP Address and DHCPv6 configuration.

IPv4 **IPv6**

**LAN IPv6 Configuration**

IPv6 Address  /

**IPv6 Address Auto Configuration**

Auto Configuration Mode

**Stateless Address Autoconfiguration**

Prefix / Prefix length  /

Route

Primary DNS

Secondary DNS

**Prefix Delegated**

**Figure 4.7.2.3 LAN Settings - IPv6 Tab (Option 2: SLAAC)**

**LAN Settings**

You can configure LAN settings of CPE device such as LAN IP Address and DHCPv6 configuration.

IPv4 **IPv6**

**LAN IPv6 Configuration**

IPv6 Address  /

**IPv6 Address Auto Configuration**

Auto Configuration Mode

**Statefull DHCPv6**

IPv6 Pool Start Address

IPv6 Pool End Address

Primary DNS

Secondary DNS

DNS Domain name

**Prefix Delegated**

**Figure 4.7.2.4 LAN Settings - IPv6 Tab (Option 3: Statefull DHCPv6 Server)**

For LAN interface, the NV-600AI uses SLAAC based prefix assignment to LAN hosts. The IPv6 prefix obtained from DHCPv6 on WAN is automatically passed to LAN hosts for their IPv6 address configuration.

The screen contains the following details:

**Fields in LAN Settings – IPv6:**

Field	Description
<b>LAN IPv6 Configuration</b>	
IPv6 Address	IPv6 Address of CPE
<b>IPv6 Address Autoconfiguration</b>	
Auto Configuration Mode	Auto Configuration Mode on LAN interface for LAN hosts. • Stateless Auto Config (SLAAC) + Statefull DHCPv6 • Stateless Auto Config (SLAAC) • Statefull DHCPv6 <b>Stateless Address Autoconfiguration</b>
<b>Stateless Address Autoconfiguration</b>	
Prefix/Prefix Length	IPv6 Prefix and Length Configuration.
Route	IPv6 Route for configuration in LAN host.
Primary DNS	Primary DNS for IPv6 name resolution.
Secondary DNS	Secondary DNS for IPv6 name resolution.
<b>Statefull DHCPv6</b>	
Primary DNS	Primary DNSv6 Address.
Secondary DNS	Secondary DNSv6 Address.
DNS Domain Name	Domain Name.

- ◆ Click **Apply** at any time during configuration to save the information that you have entered.
- ◆ Click **Cancel** to exit from this page without saving the changes.

When you click **Prefix Delegated view** button in the LAN Settings - IPv6 page, a screen is displayed as shown in [Figure 4.7.2.5](#)

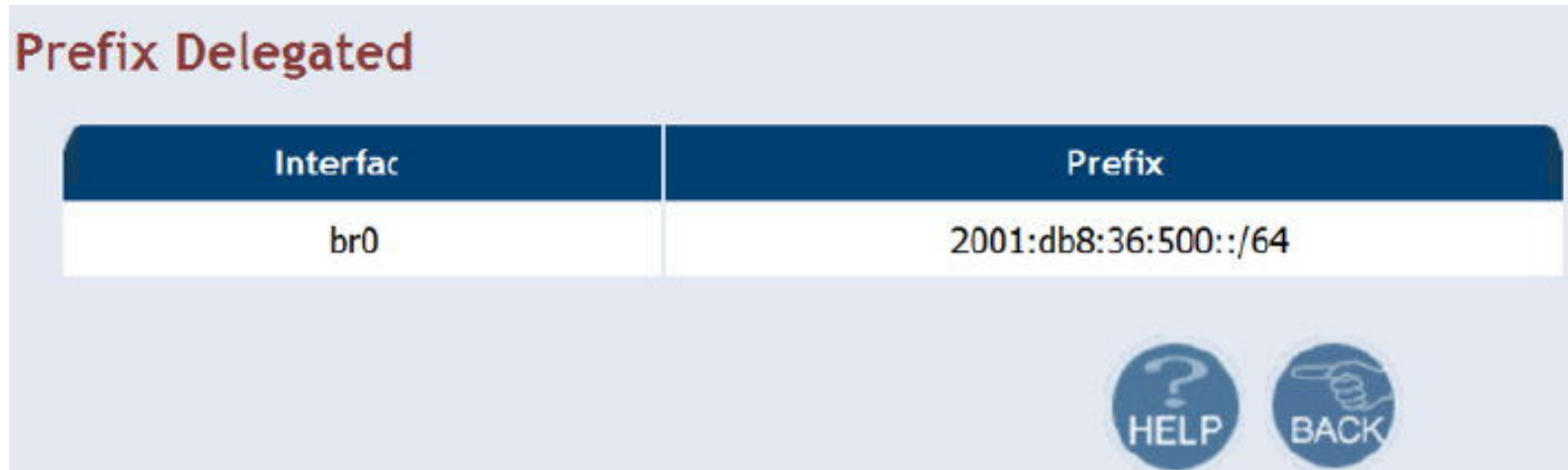

Interfac	Prefix
br0	2001:db8:36:500::/64

**Figure 4.7.2.5 Prefix Delegated view**

- ◆ Click **Back** to exit from this page.

### 4.7.3 UPnP Devices List

To discover the UPnP Devices in LAN network, click the **UPnP Devices** link (**LAN > UPnP Devices**) on the left navigation bar. A screen is displayed as shown in [Figure 4.7.3](#)

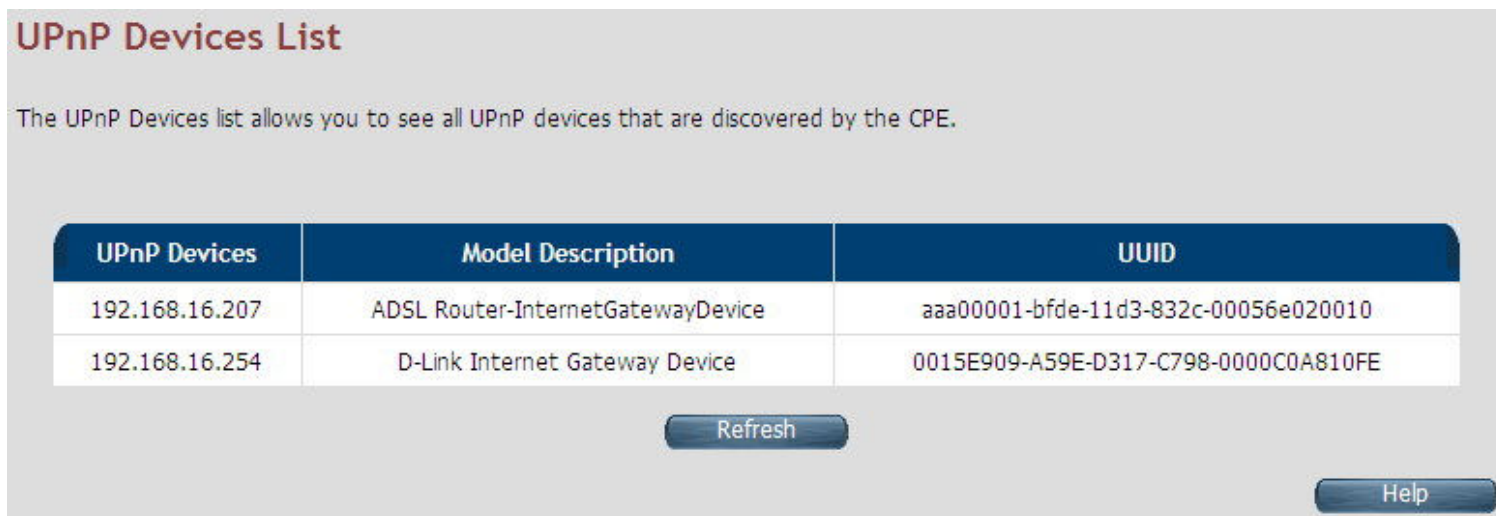

**UPnP Devices List**

The UPnP Devices list allows you to see all UPnP devices that are discovered by the CPE.

UPnP Devices	Model Description	UUID
192.168.16.207	ADSL Router-InternetGatewayDevice	aaa00001-bfde-11d3-832c-00056e020010
192.168.16.254	D-Link Internet Gateway Device	0015E909-A59E-D317-C798-0000C0A810FE

Refresh

Help

**Figure 4.7.3 UPnP device list**

The screen contains the following details:

**Fields in UPnP Device List:**

Field	Description
UPnP Devices	IP address of the device connected discovered through UPnP protocol.
Friendly Name	Name of the device connected.
UUID	Universal Unique Identifier.

- ◆ Click **Refresh** to view a new UPnP devices list.



### 4.7.4 LAN Switch Port Setting

To discover the All LAN Port Setting in LAN network, click the **LAN Switch Port Setting** link (**LAN > LAN Switch Port Setting**) on the left navigation bar. A screen is displayed as shown in [Figure 4.7.4](#)

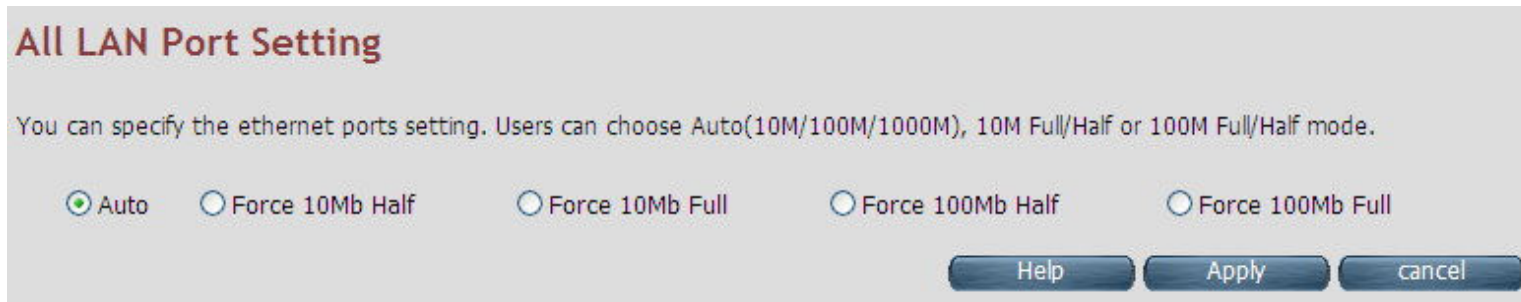
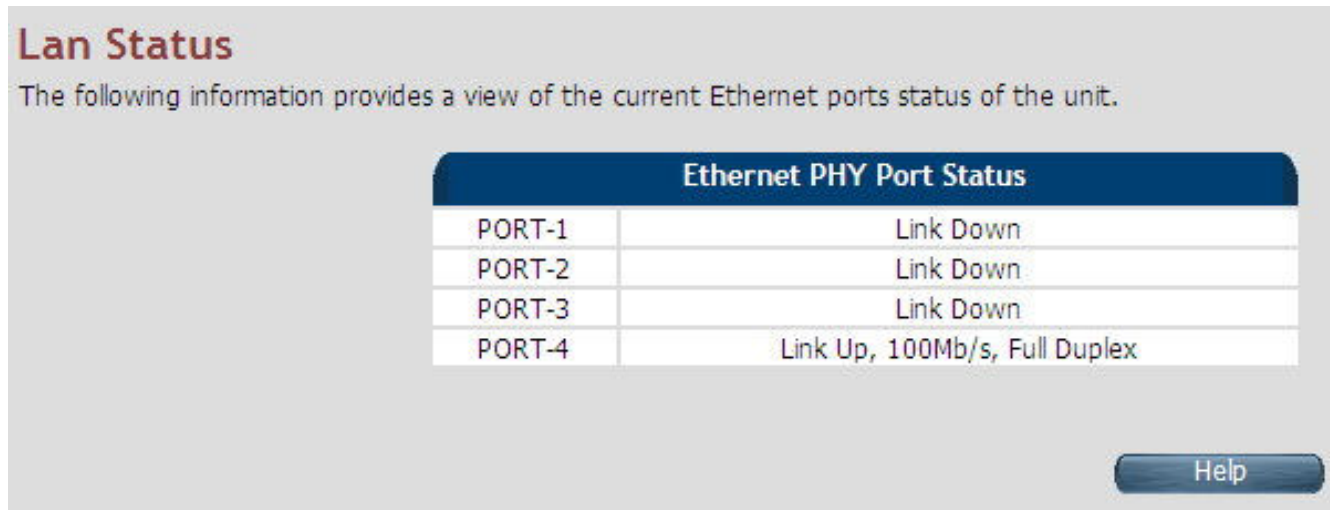

**Figure 4.7.4 All LAN Port Setting**

- ◆ Default value is “Auto 10/100 Full/Half”.
- ◆ Click APPLY to save the information that has been entered.
- ◆ Click CANCEL to exit from this page without saving the changes.

### 4.7.5 LAN Port Status

To discover the LAN Port Status in LAN network, click the **LAN Port Status** link (**LAN > LAN Port Status**) on the left navigation bar. A screen is displayed as shown in [Figure 4.7.5](#)



**Figure 4.7.5 LAN Port Status**

**Example Table:**

Input 1	Output 1	Input 2	Output 2	Input 3	Output 3	Input 4	Output 4
NWAY 10M Full	10M Full	Force 10M Full	10M Half	None	Link Down	NWAY 10M Half	10M Half
Input 5	Output 5	Input 6	Output 6	Input 7	Output 7	Input 8	Output 8
NWAY 100M Half	100M Half	Force 100M Full	100M Half	Auto 100M Full	100M full	Auto	100M FULL

#### 4.8 Select “Route”

If there are multiple routers installed on your network, it is necessary to configure the VDSL2 router unit's routing functions. Select the “Route”. The menu below includes the sub-menus of **Static Routing**, **RIP Support** and **Routing Table List**. Following are the options available under **Route** menu as shown in [Figure 4.8](#).



**Figure 4.8 Route Options on the Left Navigator Bar**

### 4.8.1 Static Routing

The static routing function determines the path that data follows over your network before and after it passes through your router. You can use static routing to allow different IP domain users to access the Internet through this VDSL2 Router device.

To setup Static Routing, click the **Static Routing** link (**Route > Static Routing**) on the left navigation bar. A screen is displayed as shown in [Figure 4.8.1](#).

**Static Routing**

The static routing function determines the path that data follows over your network before and after it passes through your router. You can use static routing to allow different IP domain users to access the Internet through this device. The default route cannot be added from this web page. The default route is added in system automatically based upon the Gateway selection in WAN Settings page.

**IPv4** IPv6

Destination IP	Subnet Mask	Gateway	Interface	
<input type="text"/> . <input type="text"/> .	<input type="text"/> . <input type="text"/> .	<input type="text"/> . <input type="text"/> .	<input type="text"/> ▾	<input type="button" value="Add"/>
<input type="text"/> . <input type="text"/>	<input type="text"/> . <input type="text"/>	<input type="text"/> . <input type="text"/>		

**Figure 4.8.1 Static Routing Configuration**

The screen contains the following details:

**Fields in Static Routing:**

Field	Description
Destination LAN IP	To enter the destination IP Address of routing entry. Enter the IP Address <b>0-0-0-0</b> of routing entry.
Subnet Mask	To enter the Subnet Mask of routing entry. Enter the Subnet Mask <b>0-0-0-0</b> of routing entry.
Gateway	To enter the Gateway address of routing entry. Enter the Gateway address of routing entry.
Interface	To enter the outgoing interface name for this route. It can be selected from dropdown.

- ◆ Click Add to create a new static route of specified destination IP, Netmask and Gateway values.
- ◆ Click **Cancel** to exit from this page without saving the changes.

**Notes:**

1. **Static Routing functionality is used to define the connected Gateway between the LAN and WAN.** For example, if we want to activate the Network Time Protocol (NTP) service, and we have to define the Gateway connected to NTP server in the WAN.
2. The gateway of static routing just used for switch(Bridged) mode.

When you click the **IPv6** tab in the Static Routing page, a screen is displayed as shown in [Figure 4.8.1.1](#) The addition and deletion of static IPv6 routes is not supported currently.

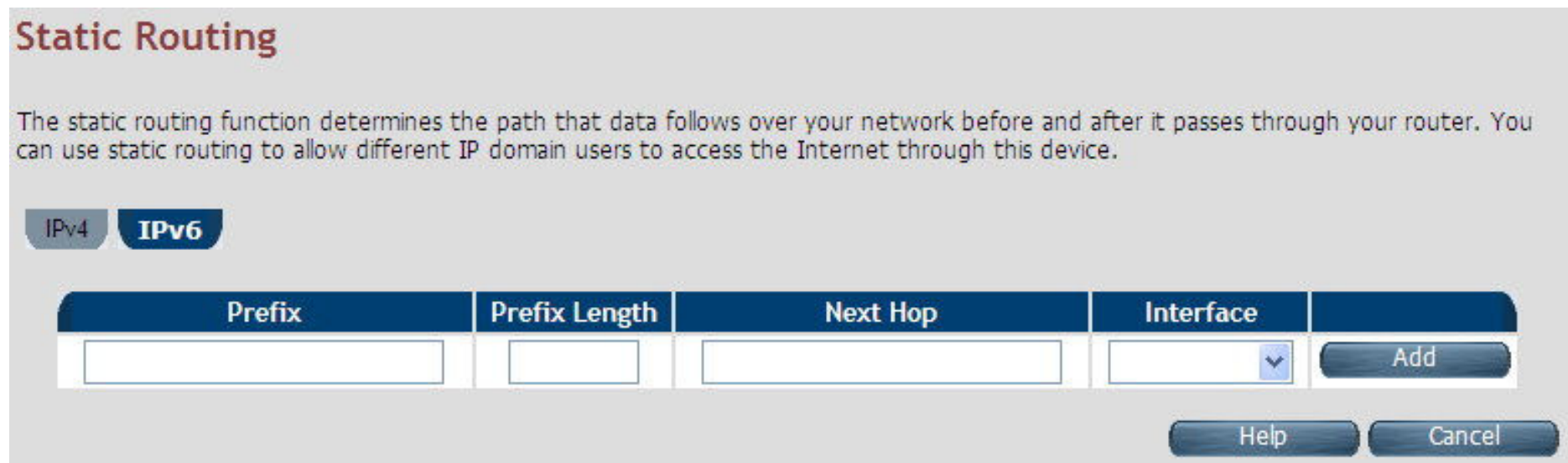

**Figure 4.8.1.1 Static Routing IPv6**

**Tip:**

Please note that default route should not be added from this web page. To configure default route, specify default Gateway on selected WAN in **WAN Setting** page.

### 4.8.2 RIP Support

The RIP support for enabling dynamic routes in CPE may be present in some of pre-built packages. To enable the RIP support, click the **RIP Support** link (**Route > RIP Support**) on the left navigation bar. A screen is displayed as shown in [Figure 4.8.2](#).

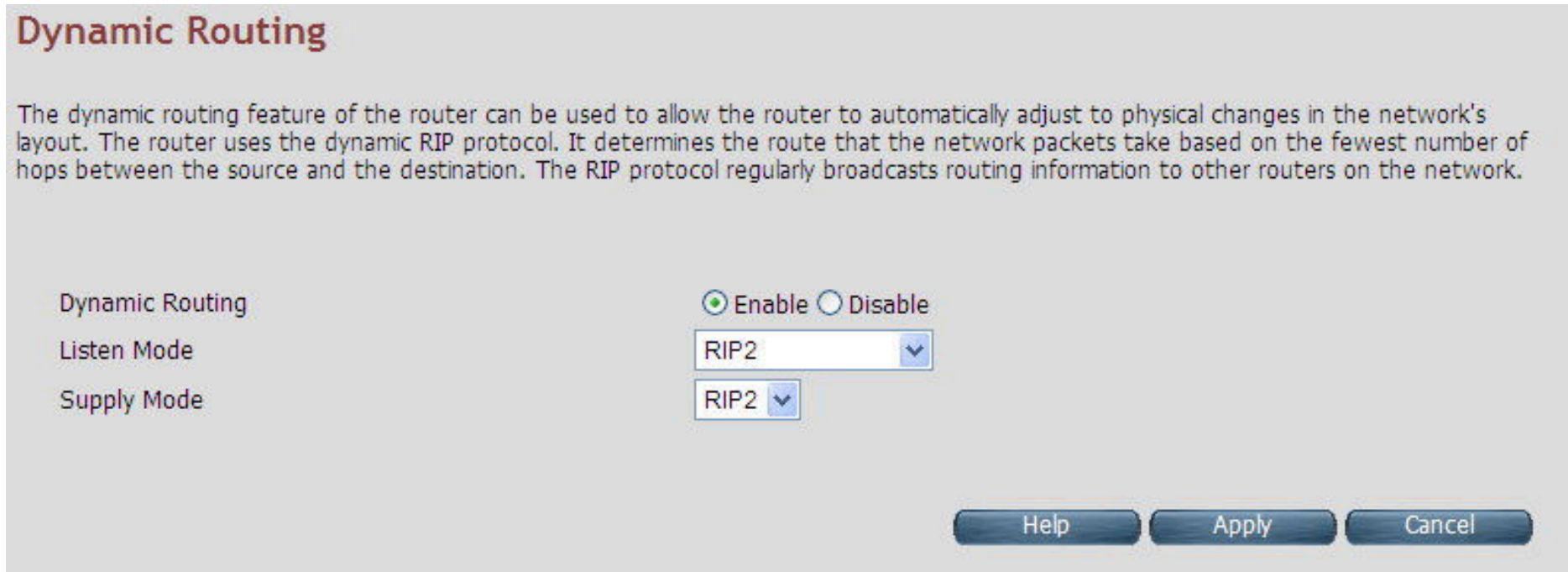

**Figure 4.8.2 Dynamic Routing**

The screen contains the following details:

**Fields in Dynamic Routing:**

Field	Description
Dynamic Routing	To enable or disable the Dynamic Routing (RIP) in CPE.
Listen Mode	To configure the listen mode of RIP to: <ul style="list-style-type: none"> <li>◆ Disabled</li> <li>◆ RIP1</li> <li>◆ RIP2</li> <li>◆ Both (RIP1 + RIP2)</li> </ul>
Supply Mode	To configure the supply mode of RIP to: <ul style="list-style-type: none"> <li>◆ Disabled</li> <li>◆ RIP1</li> <li>◆ RIP2</li> </ul>

- ◆ Click **Apply** at any time during configuration to save the information that you have entered.
- ◆ Click **Cancel** to exit from this page without saving the changes.

**Note(Reference Only):**

The Routing Information Protocol (RIP) is one of the oldest distance-vector routing protocols, which employs the hop count as a routing metric. RIP prevents routing loops by implementing a limit on the number of hops allowed in a path from the source to a destination. The maximum number of hops allowed for RIP is 15. This hop limit, however, also limits the size of networks that RIP can support. A hop count of 16 is considered an infinite distance, in other words the route is considered unreachable.



RIP implements the split horizon, route poisoning and holddown mechanisms to prevent incorrect routing information from being propagated. These are some of the stability features of RIP. It is also possible to use the Routing Information Protocol with Metric-Based Topology (RMTI) algorithm to cope with the count-to-infinity problem. With RMTI, it is possible to detect every possible loop with a very small computation effort.

RIP uses the User Datagram Protocol (UDP) as its transport protocol, and is assigned the reserved port number 520.

**RIP version 1:** The original specification of RIP, defined in RFC 1058, was published in 1988 and uses classful routing. The periodic routing updates do not carry subnet information, lacking support for variable length subnet masks (VLSM). This limitation makes it impossible to have different-sized subnets inside of the same network class. In other words, all subnets in a network class must have the same size. There is also no support for router authentication, making RIP vulnerable to various attacks.

**RIP version 2:** Due to the deficiencies of the original RIP specification, RIP version 2 (RIPv2) was developed in 1993 and last standardized in 1998. It included the ability to carry subnet information, thus supporting Classless Inter-Domain Routing (CIDR). To maintain backward compatibility, the hop count limit of 15 remained. RIPv2 has facilities to fully interoperate with the earlier specification if all Must Be Zero protocol fields in the RIPv1 messages are properly specified. In addition, a compatibility switch feature allows fine-grained interoperability adjustments.

### 4.8.3 Routing Table List

The Routing table allows you to see how many routings on your VDSL2 router routing table and interface information. To view the Routing entry table list of NV-600AI, click on the “Routing Table List” link in the left navigation bar. A screen is displayed as shown in [Figure 4.8.3](#).

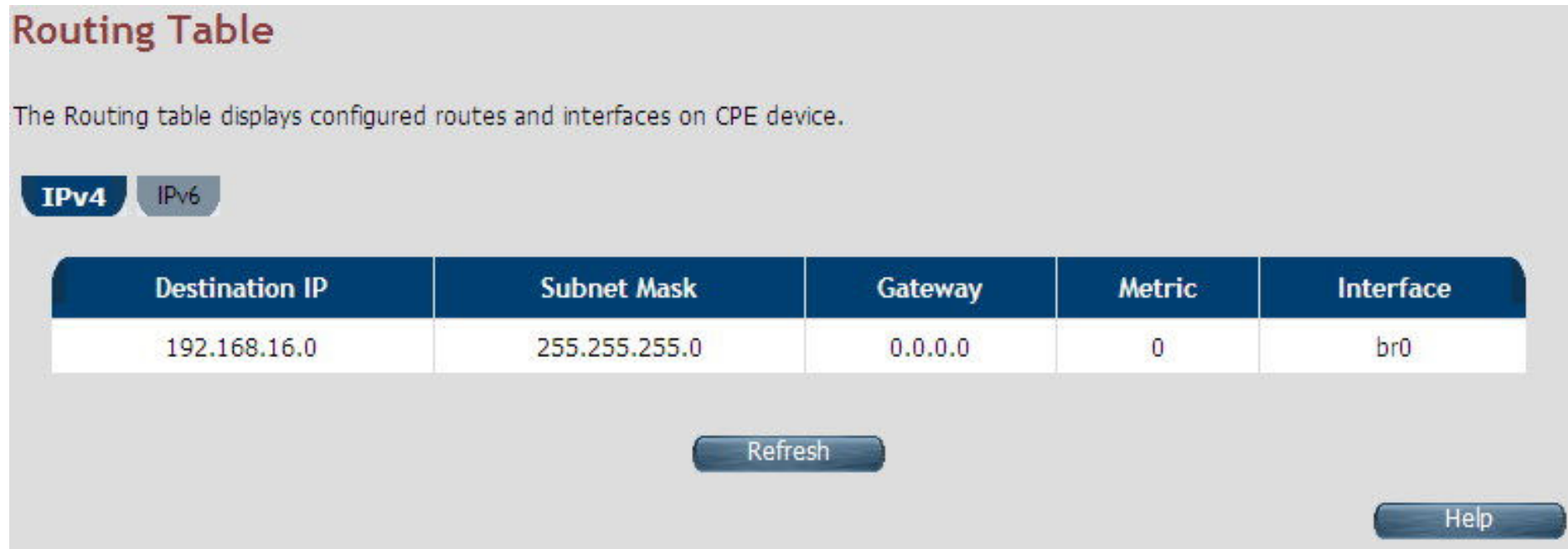

**Figure 4.8.3 Routing Table List**

The screen contains the following details:

**Fields in Static Routing:**

Field	Description
Destination IP	Destination IPv4 address for route.
Subnet Mask	Destination IPv4 subnet mask for route.
Gateway	IPv4 gateway address for this route.
Metric	Routing metric is number used by the routing protocol. Higher metrics have the effect of making a route less favorable by Router.
Interface	This depends on the interfaces currently configured in the system. Possible values are: • br0 - Bridge interface • eth0 - First ethernet interface • eth1 - Second ethernet interface (maybe connected to an external switch) • nas<i> - e.g. nas0. Ethernet over ATM interface (Applicable only to ATM WAN). • ppp<i> - e.g. ppp0. PPPoE or PPPoA interface
Refresh	When you click <b>Refresh</b> button, it will refresh the table of IPv4 routes by gathering fresh list of routes from system.

**Routing Table List - IPv6 Tab**

If IPv6 functionality is enabled through (**Quick Setup > IPv6**), then the Routing Table List web page also lists all IPv6 routes in system under IPv6 tab as shown in [Figure 4.8.3.1](#)

**Routing Table**

The Routing table displays configured routes and interfaces on CPE device.

IPv4 **IPv6**

Destination	Next Hop	Metric	Interface
fc00::/64	::	256	br0
fe80::/64	::	256	br0
fe80::/64	::	256	eth0
ff02::1/128	ff02::1	0	br0
ff00::/8	::	256	br0
ff00::/8	::	256	eth0
ff00::/8	::	256	ptm0
ff00::/8	::	256	ptm0.201

Refresh

Help

\*IPv6 functionalities are not supported in this software version

**Figure 4.8.3.1 Routing List – IPv6 Tab**

## 4.9 Select “Firewall”

You can view **Firewall** link on the left navigation bar of the NV-600AI CPE homepage. The menu below includes the sub-menus of **Firewall Setting**, **IPv6 Firewall Setting**, **Packet Filtering**, **URL Filtering**, **Parental Control**, **Application Server Settings** and **ACL**. Following are the options available under **Firewall** as shown in [Figure 4.9](#)

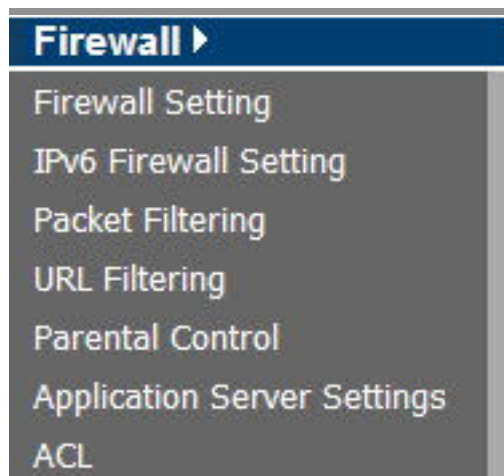

**Figure 4.9 Firewall Options**

### 4.9.1 Firewall Setting

To enable or disable the firewall, click the **Firewall Setting** link (**Firewall > Firewall Setting**) on the left navigation bar. A screen is displayed as shown in [Figure 4.9.1](#)

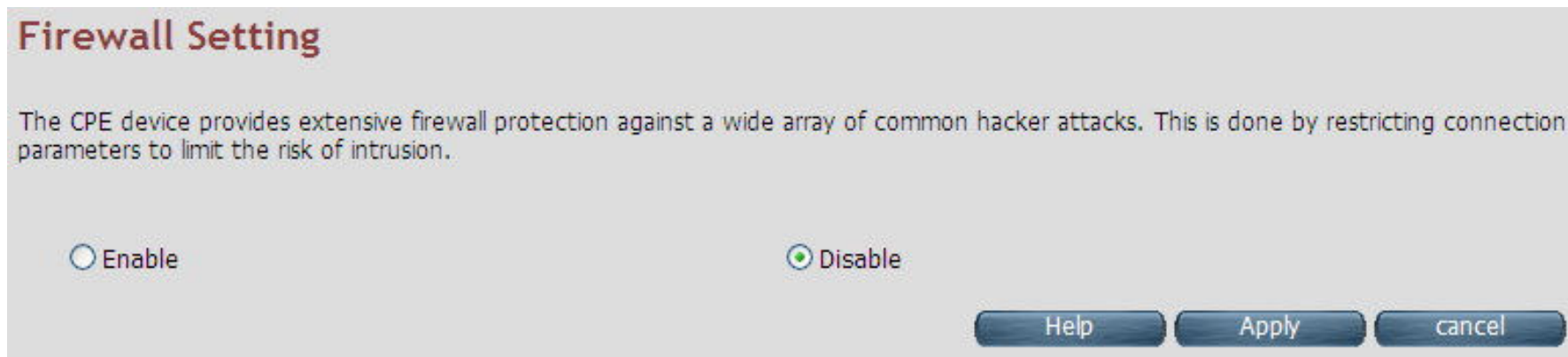

**Figure 4.9.1 Firewall Setting**

The screen contains the following details:

**Fields in Firewall Setting:**

Field	Description
Firewall Setting	It allows to ENABLE or DISABLE the firewall in UGW.

- ◆ Click APPLY at any time during configuration to save the information that you have entered.
- ◆ Click CANCEL to exit from this page without saving the changes.

### 4.9.2 IPv6 Firewall Setting

To enable or disable the firewall, click the **IPv6 Firewall Setting** link (**Firewall > IPv6 Firewall Setting**) on the left navigation bar. A screen is displayed as shown in [Figure 4.9.2](#)

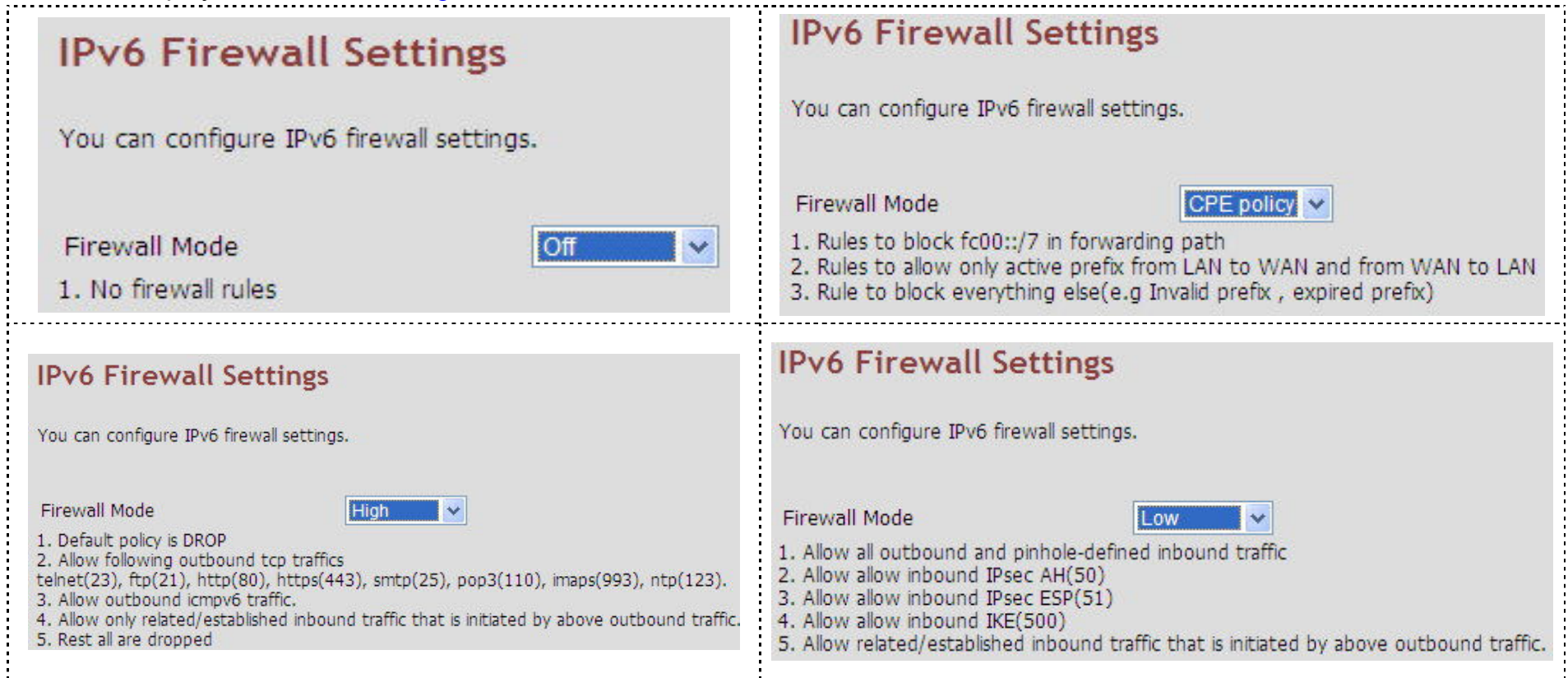

**Figure 4.9.2 IPv6 Firewall Setting**

The screen contains the following details:

**Fields in UPnP Settings:**

Field	Description
Firewall Mode	The available options are <b>Off</b> , <b>CPE policy</b> , <b>High</b> and <b>Low</b> .

- ◆ Click APPLY for committing the desired action.
- ◆ Click CANCEL to exit from this page without saving the changes.



### 4.9.3 Packet Filtering

To enable Packet Filtering, click the **Packet Filtering** link (**Firewall > Packet Filtering**) on the left navigation bar. A screen is displayed as shown in [Figure 4.9.3](#)

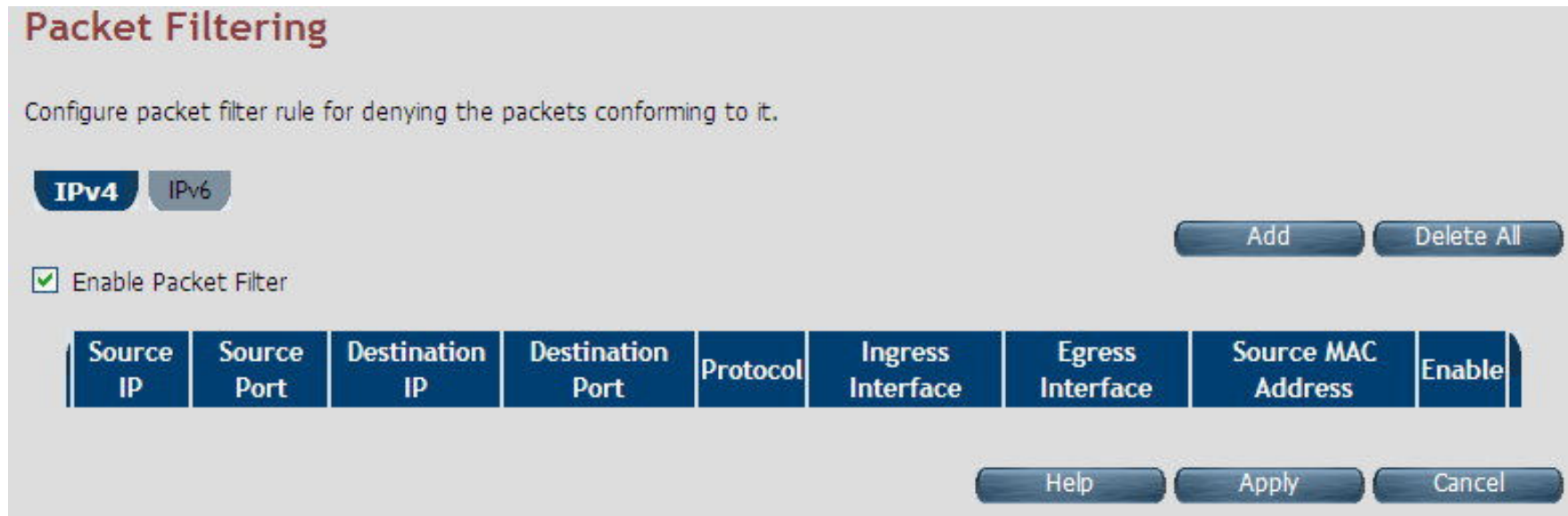

**Figure 4.9.3 Packet Filtering**

The screen contains the following details:

**Fields in Packet Filtering:**

Field	Description
IPV4/IPv6	Choose the appropriate tab to configure.
Enable Packet Filter	To enable or disable the Packet Filter feature of NV-600AI CPE. To enable, select the check box.
Source IP	Filter IP Address range of the local machine under NV-600AI CPE.
Source Port	Filter Port number range of the local machine under NV-600AI CPE.
Destination IP	IP address of the destination.
Destination Port	Port address of the destination.
Protocol	Filter protocol. (TCP or UDP).
Ingress Interface	Input interface of the packet.
Egress Interface	Output interface of the packet.
Source MAC Address	Source MAC Address of packet originating host.
Enable	To provide more IP Addresses of the WAN interface.
Add	On pressing Add button, the screen shown in <a href="#">Figure 4.9.3.1</a> is displayed for adding a new packet filtering rule in system.
Delete All	To delete all the packet filtering rules configured in system.

- ◆ Click Apply at any time during configuration to save the information that you have entered.
- ◆ Click CANCEL to exit from this page without saving the changes.

When you have chosen IPv4 tab, and click Add button in the Packet Filtering page, a screen is displayed as shown in Figure 104. If you choose IPv6 tab and click on Add button, a screen is displayed as shown in [Figure 4.9.3.2](#).

**Add a packet filtering rule**

Allows to create a packet filtering rule thereby conforming traffic is denied access.

Protocol	ALL
Source IP Type	SUBNET
Source IP Address	
Source Netmask	
Source Port	~
Destination IP Type	SUBNET
Destination IP Address	
Destination Netmask	
Destination Port	~
Ingress Interface	
Egress Interface	
Source MAC Address	
Enable	<input type="checkbox"/>

Help Apply Cancel

**Figure 4.9.3.1 Add a Packet Filtering Rule for Firewall - IPv4**

The screen contains the following details:

**Fields in“Add a Packet Filtering Rule” page:**

Field	Description
Protocol	To select the protocol. The options available are ALL, TCP, UDP, ICMP, AH and ESP.
Source IP	The source IP can be a SINGLE address or a SUBNET, involving a range of IP addresses.
IP Address	To specify the source IP address.
Netmask	To specify the netmask for the source address.
Source Port	To specify the range of the source port. Valid for protocols TCP or UDP only.
Destination IP Type	The destination IP can be a SINGLE address or a SUBNET or All involving a range of IP addresses.
IP Address	To specify the destination IP address.
Netmask	To specify a netmask for the destination IP address.
Destination Port	To specify the range of the destination port. Valid for protocols TCP or UDP only.
Ingress Interface	To specify the input interface of the packet from dropdown options. (e.g. WAN1).
Egress Interface	To specify the output interface of the packet from dropdown options. (e.g. WAN2).
Source MAC Address	This is the source hosts's MAC address.
Enable	To enable/disable the particular packet filtering rule.

- ◆ Click Apply at any time during configuration to for adding the packet filtering rule.
- ◆ Click CANCEL to exit from this page without saving the changes.

### Add a packet filtering rule

Allows to create a packet filtering rule thereby conforming traffic is denied access.

Ingress Interface	Any	<input type="checkbox"/> Exclude
Egress Interface	Any	<input type="checkbox"/> Exclude
IP Version	IPv6	
IPv6 Destination Address	<input type="text"/> / <input type="text"/>	<input type="checkbox"/> Exclude
IPv6 Source Address	<input type="text"/> / <input type="text"/>	<input type="checkbox"/> Exclude
Protocol	Any	<input type="checkbox"/> Exclude
Destination Port	<input type="text"/> ~ <input type="text"/>	<input type="checkbox"/> Exclude
Source Port	<input type="text"/> ~ <input type="text"/>	<input type="checkbox"/> Exclude
Target	Drop	
Enable this rule	<input checked="" type="checkbox"/>	

Help Apply Cancel

**Figure 4.9.3.2 Add a Packet Filtering Rule for Firewall - IPv6**

The screen contains the following details:

**Fields in “Add a Packet Filtering Rule - IPv6” page:**

Field	Description
Ingress Interface	To specify the input interface of the packet from dropdown options. (e.g. WAN1).
Egress Interface	To specify the output interface of the packet from dropdown options. (e.g. WAN2).
Exclude	To exclude the selected option.
IP Version	Displays the IP version.
IP Source Address	To specify the source IP address.
Protocol	To select the protocol. The options available are ALL, TCP, UDP, ICMP, AH and ESP.
Source Port	To specify the range of the source port. Valid for protocols TCP or UDP only.
Destination Port	To specify the range of the destination port. Valid for protocols TCP or UDP only.
Destination IP Type	The destination IP can be a SINGLE address or a SUBNET or All involving a range of IP addresses.
Exclude	To exclude the selected option.
Target	The available options are Drop, Reject and Accept.
Enable this rule	Enable/disable this rule.

- ◆ Click Apply at any time during configuration to for adding the packet filtering rule.
- ◆ Click CANCEL to exit from this page without saving the changes.

◆ Packet Filtering configuration example:

**1. Packet Filter configuration procedures:**

- (1). All devices must be connected and turned on.
- (2). Confirm that the NV-600AI is in router mode (default mode).
- (3). If there is not router mode, please refer to the following configuration diagram to configure the router mode and packet filter.
- (4). All the configuration arguments are for reference only.

**1. Router mode configuration:**

◆ WAN setting

**WAN**

The CPE device can be connected to your service provider in any of the following ways

Attached Channel: 0. ptm0

WAN TYPE: Static IP Address

IP address assigned by your ISP: 192 . 168 . 16 . 204

Subnet Mask: 255 . 255 . 255 . 0

ISP Gateway Address: 192 . 168 . 16 . 1

Default WAN:

Help Apply Cancel

**Configure example: WAN→WAN Setting**

Items	Setting argument / Action
Attached Channel	Default
WAN TYPE	Static IP Address
IP address assigned by tour ISP	WAN IP: 192.168.16.204 (Example)
Subnet Mask	255.255.255.0 (Example)
ISP Gateway Address	192.168.16.1(Example)
Default WAN	Please check box
Apply Button	Click it

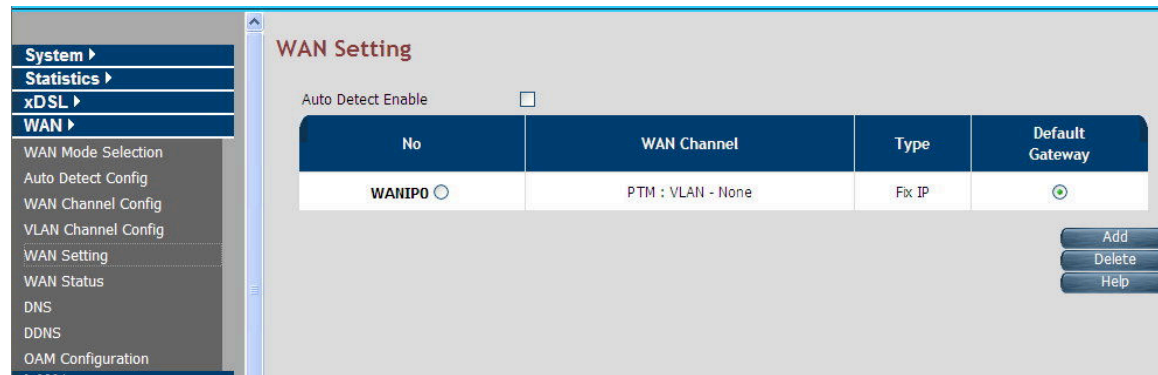

**WAN setting complete**



◆ LAN Setting

**LAN Settings**

You can configure LAN settings of CPE device such as LAN IP Address and DHCP configuration.

IP Address: 192 . 168 . 1 . 204  
 Subnet Mask: 255 . 255 . 255 . 0  
 MAC Address: 00 : 05 : 8e : 02 : 00 : 03

Secondary level subnet Range  Enable

DHCP Mode: Server

**DHCP Server**

IP Pool Starting Address: 192 . 168 . 1 . 30  
 IP Pool Ending Address: 192 . 168 . 1 . 50  
 Lease Time: One day  
 Local Domain Name: dslgw.com (optional)

**IP Address Reservation**

[Click Here](#)

Buttons: Help, **Apply**, Cancel

**Configure example: LAN→LAN Settings**

Items	Setting argument / Action
IP Address	LAN IP: 192.168.1.204 (Example)
Subnet Mask	255.255.255.0(Example)
MAC Address	NV-600W mac address(Auto detect)
DHCP Server	Server
IP Pool Starting Address	192.168.1.30 (DHCP IP pool example)
IP Pool Ending Address	192.168.1.50 (DHCP IP pool example)
Apply Button	Click it

◆ **DNS Setting**

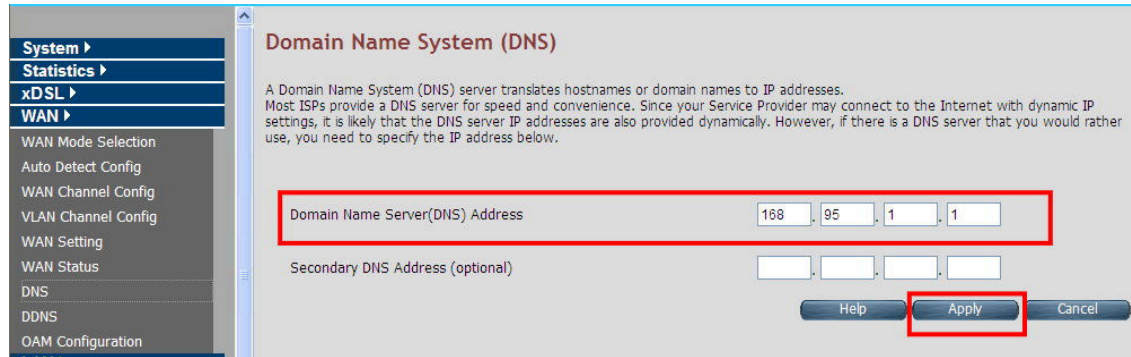

**Configure example: WAN→DNS**

Items	Setting argument / Action
DNS Address	DNS IP: 168.95.1.1 (Example)
Apply Button	Click it

**Note:** When configuration is completed with the above arguments, please reboot the NV-600AI.

◆ PC NIC card setting

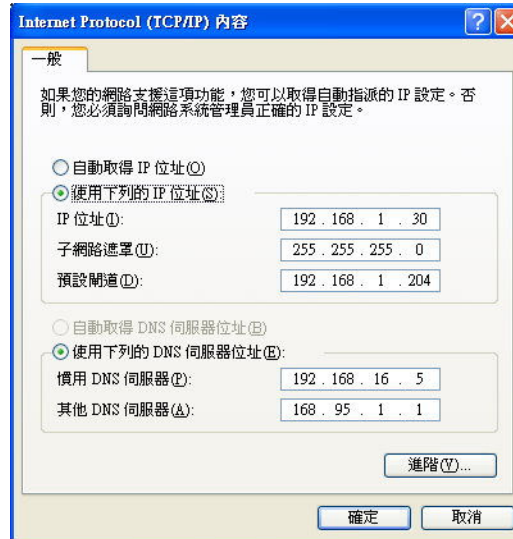

**Configure example:**

Items	Setting argument / Action
IP Address	PC LAN IP: 192.168.1.30 (Example)
Subnet Mask	255.255.255.0 (Example)
Gateway	192.168.1.204 (Example)
DNS	192.168.16.5 (Example)

### 3. Packet Filtering configuration:

#### ◆ NV-600AI Packet Filtering

**Modify packet filtering rule**

Filtering Internet access for LAN clients can be controlled from here based on IP address.

Protocol	TCP
Source IP Type	ALL
Source IP Address	
Source Netmask	
Source Port	3671 ~ 3671
Destination IP Type	SUBNET
Destination IP Address	192.168.1.0
Destination Netmask	255.255.255.0
Destination Port	3671 ~ 3671
Ingress Interface	
Egress Interface	
Source MAC Address	
Enable	<input checked="" type="checkbox"/>

Help **Apply** Cancel

**Configure example: Firewall→Packet Filtering**

Items	Setting argument / Action
Protocol	TCP (Example)
Source IP Type	ALL (All source IP Address)
Source port	3671~3671
Destination IP Type	Subnet
Destination IP Address	192.168.1.0 (Example, it means 192.168.1.0~192.168.16.255)
Destination Netmask	255.255.255.0 (Example)
Destination port	3671~3671
Enable	Please check box
Apply Button	Click it

**Packet Filtering**

Configure packet filter rule for denying the packets conforming to it.

Enable Packet Filter

	Source IP	Source Port	Destination IP	Destination Port	Protocol	Ingress Interface	Egress Interface	Source MAC Address	Enable	
1	*	3671~3671	192.168.1.0/24	3671~3671	TCP				<input checked="" type="checkbox"/>	Modify Delete

Help **Apply** Cancel

**Packet filtering complete**

◆ **Enable Firewall function:**

The firewall has to be enabled in order to start the packet filter.



**Note:**

All the setting arguments above are examples; please follow the on-site environment to set.

### 4.9.4 URL Filtering

Using URL Filtering, the user can block the access to specific URLs to the web users by adding them to the list in the URL Blocking web page. To configure the URL Filtering, click the **URL Filtering** link (**Firewall > URL Filtering**) on the left navigation bar. A screen is displayed as shown in [Figure 4.9.4](#)



**Figure 4.9.4 URL Blocking**

The screen contains the following details:

**Fields in URL Blocking:**

Field	Description
Domain Name	URL of the domain that needs to be blocked. For example: www.google.com.tw
Select	Select this option to remove the URL entry from blocked list.

- ◆ Click Add for adding a new URL filtering entry.
- ◆ Click Delete for deleting the existing URL filtering entry.



### 4.9.5 Parental Control

To configure the Parental Control, click the **Parental Control** link (**Firewall > Parental Control**) on the left navigation bar. A screen is displayed as shown in [Figure 4.9.5](#)

**Parental Control**

You can block access, based on MAC addresses and Time of Day, to certain client PCs on the LAN.

MAC Address Control :  Disable  Deny All  Permit All

MAC Address Control List														
Policy	MAC Address				Date/Time Select									
					Mon	Tue	Wed	Thu	Fri	Sat	Sun		Begin hh:mm	End hh:mm
Disable ▾	<input type="text"/>	<input type="text"/>	<input type="text"/>	<input type="text"/>	<input type="checkbox"/>	<input type="checkbox"/>	<input type="checkbox"/>	<input type="checkbox"/>	<input type="checkbox"/>	<input type="checkbox"/>	<input type="checkbox"/>	<input type="text"/>	<input type="text"/>	<input type="button" value="Add"/>

**Figure 4.9.5 Parental Control Configuration**

The screen contains the following details:

**Fields in Parental Control:**

Field	Description
MAC Address Control	To disable/"deny all"/"permit all" - MAC address control feature.
MAC Address Control List	
Policy	To specify whether the particular MAC address is disabled, denied or permitted.
MAC Address	To assign the controlled MAC address for local machine.
Date/Time Select	To select the day(s) and time slot when the policy has to be applied on the MAC address provided. The Begin time entered should not be later than the End time and should be in the 24 hour format (hh:mm).

- ◆ Click Add at any time during configuration to add the specified MAC address entry in the table.
- ◆ Click Apply at any time during configuration to save the information that you have entered.
- ◆ Click Cancel to exit from this page without saving the changes.

### 4.9.6 Application Server Settings

To configure the Application Server Settings, click the **Application Server** Settings link (**Firewall > Application Server Settings**) on the left navigation bar. A screen is displayed as shown in [Figure 4.9.6](#)

Service	Accept from WAN	Port	Accept from LAN
Https Web Server	<input checked="" type="checkbox"/>	443	
Http Web Server	<input checked="" type="checkbox"/>	80	<input checked="" type="checkbox"/>
Telnet Server	<input checked="" type="checkbox"/>	23	<input checked="" type="checkbox"/>
TFTP Server	<input checked="" type="checkbox"/>	69	<input checked="" type="checkbox"/>
FTP Server	<input checked="" type="checkbox"/>	21	<input checked="" type="checkbox"/>
SNMP	<input type="checkbox"/>		

**Figure 4.9.6 Application Server Settings**

The screen contains the following details:

**Fields in Application Servers Settings:**

Field	Description
Web Server	Web Server settings: ◆ The acceptance from WAN ◆ The Port Number ◆ The acceptance from LAN
Telnet Server	Telnet Server settings: ◆ The acceptance from WAN ◆ The Port number ◆ The acceptance from LAN
TFTP Server	TFTP Server Settings: ◆ The acceptance from WAN ◆ The Port number ◆ The acceptance from LAN
FTP Server	FTP Server Settings: ◆ The acceptance from WAN ◆ The Port number ◆ The acceptance from LAN
FTP Server	FTP Server Settings: ◆ The acceptance from WAN ◆ The Port number ◆ The acceptance from LAN
SNMP	SNMP Server Settings: ◆ Acceptance from WAN

- ◆ Click Apply for committing the App Server settings.
- ◆ Click Cancel to exit from this page without saving the changes.

### 4.9.7 Access Control List (ACL)

To configure the access control list, click the **ACL** link (**Firewall > ACL**) on the left navigation bar. This can be used for allowing specified IP addresses to access the NV-600AI CPE from WAN. The system allows upto 16 ACL entries to be configured in the CPE device. A screen is displayed as shown in [Figure 4.9.7](#).

**Access Control - IP Address**

Access to the device is restricted to IP Addresses listed here

Enable ACL

No	IP Address
1	<input type="text"/>
2	<input type="text"/>
3	<input type="text"/>
4	<input type="text"/>
5	<input type="text"/>
6	<input type="text"/>
7	<input type="text"/>
8	<input type="text"/>
9	<input type="text"/>
10	<input type="text"/>
11	<input type="text"/>
12	<input type="text"/>
13	<input type="text"/>
14	<input type="text"/>
15	<input type="text"/>
16	<input type="text"/>

**Figure 4.9.7 Application Server Settings**

The screen contains the following details:

**Fields in ACL Setting:**

Field	Description
Enable ACL	To enable/disable ACL settings.
IP Address	If ACL is enabled, the IP addresses specified here are allowed to access device.

- ◆ Click Apply after filling the IP address for adding the entry in ACL list.
- ◆ Click Cancel to exit from this page without saving the changes.

## 4.10 NAT

You can view the NAT on the left navigation bar of the NV-600AI CPE homepage. The menu below includes the sub-menus of **NAT Settings**, **Virtual Server**, **Port Triggering** and **DMZ**. Following are the options available under NAT as shown in [Figure 4.10](#)

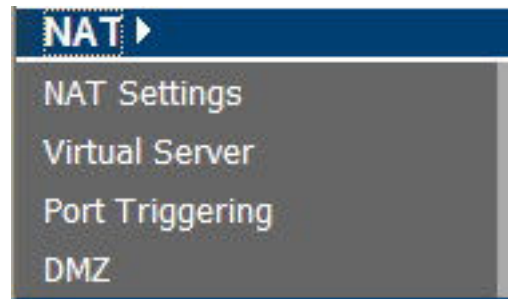

**Figure 4.10 NAT Options**

### 4.10.1 NAT Settings

To configure Network Address Translation (NAT), click the **NAT Settings** link (**NAT > NAT Settings**) on the left navigation bar. A screen is displayed as shown in [Figure 4.10.1](#)

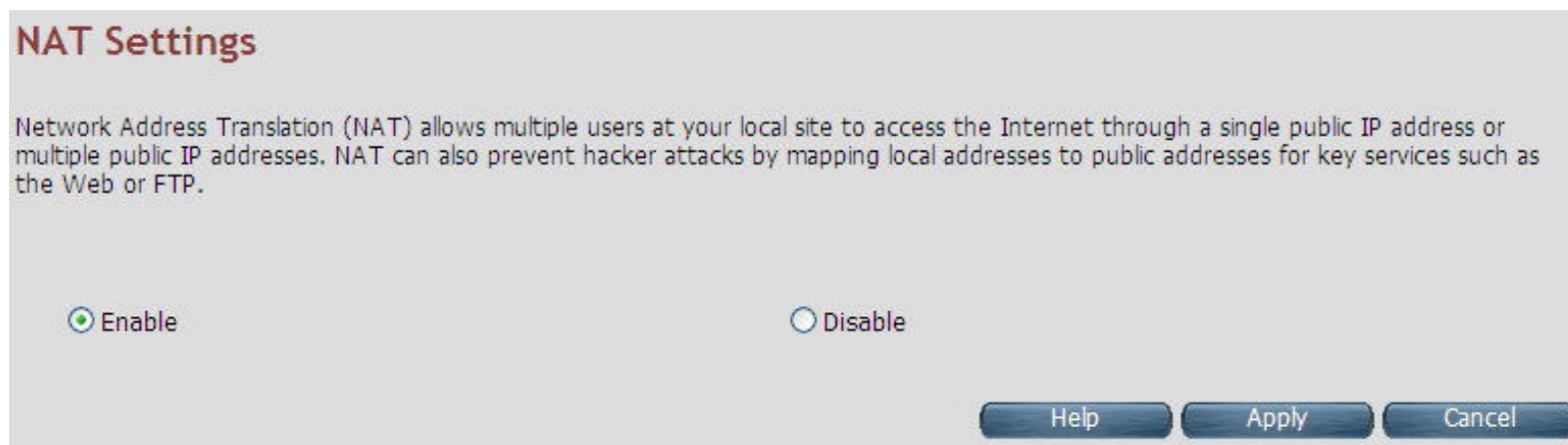

**Figure 4.10.1 Network Address Translation (NAT) Settings**

The screen contains the following details:

**Fields in Network Address Translation:**

Field	Description
NAT Settings	Used to Enable or Disable the Network Address Translation feature.

- ◆ Click Apply for activating or deactivating the NAT feature.
- ◆ Click CANCEL to exit from this page without saving the changes.



### 4.10.2 Virtual Server

To configure the virtual server, click the **Virtual Server** link (**NAT > Virtual Server**) on the left navigation bar. A screen is displayed as shown in [Figure 4.10.2](#)

**Virtual Server**

You can configure the CPE device as a virtual server so that remote users accessing services such as the Web or FTP at your local site via public IP addresses can be automatically redirected to local servers configured with private IP addresses. In other words, depending on the requested service (TCP/UDP port numbers), the CPE device redirects the external service request to the appropriate server (located at another internal IP address).

[Add](#)

	Application name	Private IP	Remote IP	Private Start Port	Private End Port	Protocol	Public Start Port	Public End Port	Enable	WAN Interface	Port Type	
1	Skype UDP at 192.168.16.21:31082 (2382)	192.168.16.21	*	31082		UDP	31082		<input checked="" type="checkbox"/>	WANPPP1	Dynamic	Delete Modify
2	Skype TCP at 192.168.16.21:31082 (2382)	192.168.16.21	*	31082		TCP	31082		<input checked="" type="checkbox"/>	WANPPP1	Dynamic	Delete Modify
3	Skype UDP at 192.168.16.16:49285 (2382)	192.168.16.16	*	49285		UDP	49285		<input checked="" type="checkbox"/>	WANPPP1	Dynamic	Delete Modify
4	Skype TCP at 192.168.16.16:49285 (2382)	192.168.16.16	*	49285		TCP	49285		<input checked="" type="checkbox"/>	WANPPP1	Dynamic	Delete Modify

**Figure 4.10.2 Virtual Server**

The screen contains the following details:

**Fields in Virtual Server Page:**

Field	Description
Application Name	Configured Application Name for Virtual Server rule.
Private IP	Private IP address of Virtual Server rule.
Remote IP	Remote IP address of Virtual Server rule.
Private Start Port	Private Port starting range.
Private End Port	Private Port ending range. for single port the start and end both are same
Protocol	Virtual Server protocol - TCP or UDP or Both i.e. TCP/UDP.
Public Start Port	Public Port starting range.
Public End Port	Public Port ending range. for single port the start and end both are same
Enabled	To enable the specified entry of the virtual server.
WAN Interface	WAN interface on which the Virtual Server rule is configured.

- ◆ Click Add to add a Virtual Server entry.

When you click Add button in the Virtual Server page, a screen opens with a new web page as shown in [Figure 4.10.2.1](#)

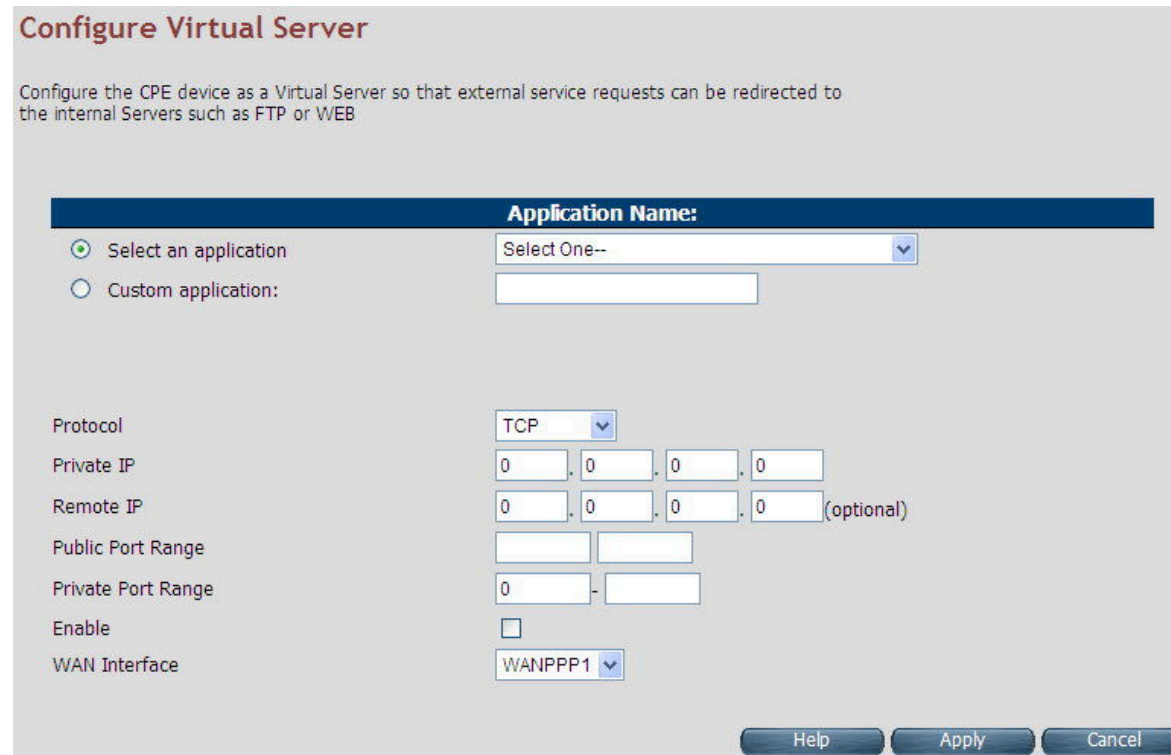

**Configure Virtual Server**

Configure the CPE device as a Virtual Server so that external service requests can be redirected to the internal Servers such as FTP or WEB

**Application Name:**

Select an application

Custom application:

Protocol: TCP

Private IP: 0 . 0 . 0 . 0

Remote IP: 0 . 0 . 0 . 0 (optional)

Public Port Range:

Private Port Range: 0  -

Enable:

WAN Interface: WANPPP1

Help Apply Cancel

**Figure 4.10.2.1 Virtual Server Add**

The screen contains the following details:

**Fields in Virtual Server - Add:**

Field	Description
Application Name	Specify Application name from dropdown or custom name for Virtual Server rule.
Protocol	Specify Virtual Server protocol - TCP or UDP or Both i.e. TCP/UDP.
Private IP	Specify Private IP address of Virtual Server rule.
Remote IP	Specify Remote IP address of Virtual Server rule.
Public Port Range	Specify Public Port range.
Private Port Range	Specify Private Port range. For single port, the start and end both are same.
Enabled	To enable the specified entry of the virtual server, tick on check box.
WAN Interface	Specify WAN interface on which the Virtual Server rule is configured.

- ◆ Click Apply at any time during configuration to save the information that you have entered.
- ◆ Click CANCEL to exit from this page without saving the changes.

**Note:**

1. NV-600AI can be set up to support up to 48 virtual servers.

### 4.10.3 Port Triggering

To configure Port Triggering, click the **Port Triggering** link (**NAT > Port Triggering**) on the left navigation bar. A screen is displayed as shown in [Figure 4.10.3](#)

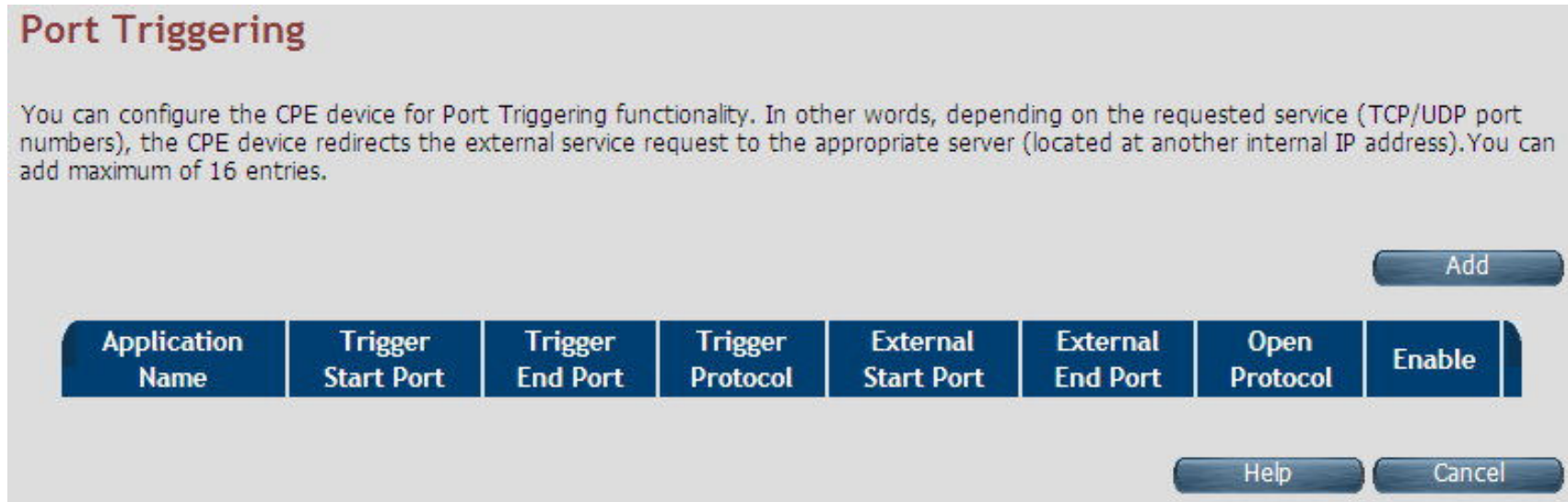

**Figure 4.10.3 Port Triggering**

The screen contains the following details:

**Fields in Port Triggering:**

Field	Description
Application Name	Port Triggering Application Name
Trigger Start Port	Trigger Port start range.
Trigger End Port	Trigger Port End Range. In case of one port, the end and start both are same.
Trigger Protocol	Trigger Protocol - TCP, UDP or TCP/UDP.
External Start Port	External Port Start range.
External End Port	External Port End Range.
Open Protocol	Protocol to be opened from external input - TCP, UDP or TCP/UDP.
Enable	Enable or Disable of Port Triggering Rule.
Add	Add a Port Triggering entry.

- ◆ Click Cancel to exit from this page without saving the changes.

When you click Add button in the Port Triggering page, a screen is displayed as shown in [Figure 4.10.3.1](#).

**Configure Port Triggering**

Some applications such as games, video conferencing, remote access applications and others require that specific ports in the Router's firewall be opened for access by the applications. You can configure the port settings from this screen by selecting an existing application or creating your own (Custom application) and click "Save/Apply" to add it.

**Application Name:**

Select an application:

Custom application:

Trigger Port Start	Trigger Port End	Trigger Protocol	Open Port Start	Open Port End	Open Protocol	Enable
<input type="text"/>	<input type="text"/>	TCP	<input type="text"/>	<input type="text"/>	TCP	<input type="checkbox"/>

**Figure 4.10.3.1 Port Triggering Add**

The screen contains the following details:

**Fields in Port Triggering:**

Field	Description
Application Name	Port Triggering Application Name.
Trigger Port Start	Trigger Port start range.
Trigger Port End	Trigger Port End Range. In case of one port, the end and start both are same.
Trigger Protocol	Trigger Protocol - TCP, UDP or TCP/UDP.
Open Port Start	Open Port Start range.
Open Port End	Open Port End range.
Open Protocol	Protocol to be opened from external input - TCP, UDP or TCP/UDP.
Enable	Enable or Disable the Port Triggering Rule.

- ◆ Click Apply at any time during configuration to save the information that you have entered.
- ◆ Click CANCEL to exit from this page without saving the changes.



### 4.10.4 DMZ

To configure the DMZ (Demilitarized Zone), click the **DMZ** link (**NAT > DMZ**) on the left navigation bar. Upon configuration of DMZ all traffic sent towards RG would be unconditionally forwarded to DMZ Lan Host. A screen is displayed as shown in [Figure 4.10.4](#).

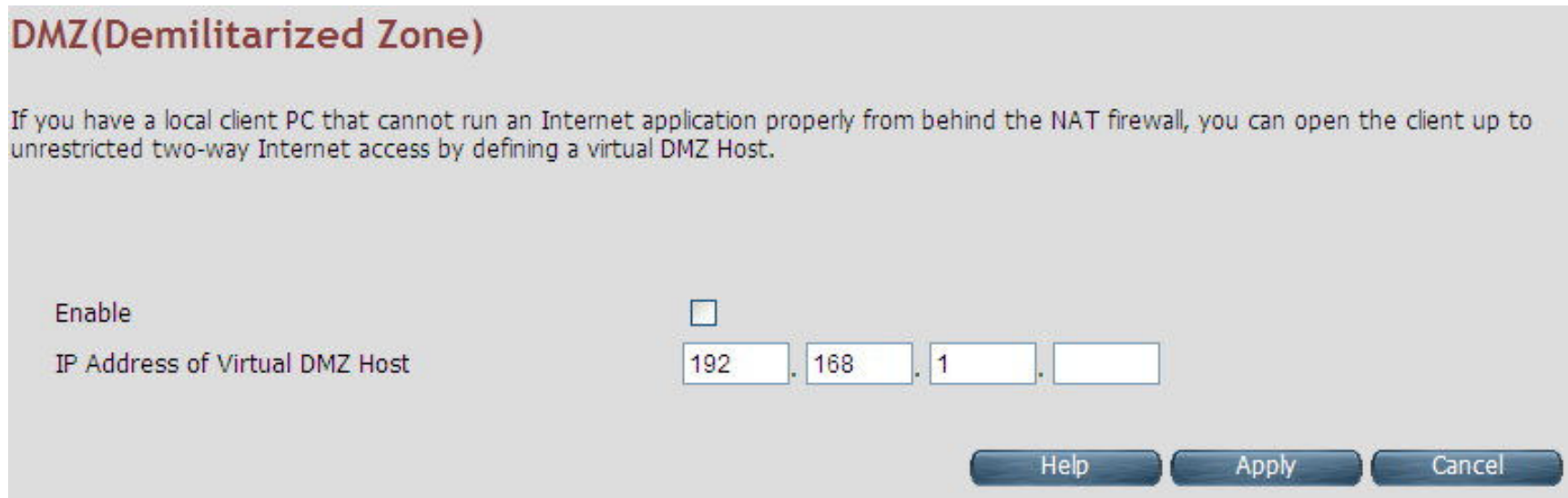

**Figure 4.10.4 DMZ (Demilitarized Zone)**

The screen contains the following details:

**Fields in DMZ:**

Field	Description
Enable	To enable or disable the DMZ setting of NV-600AI CPE. Select the check box to enable.
IP Address of Virtual DMZ Host	To enter IP Address of the DMZ host.

- ◆ Click Apply for applying the configured DMZ.
- ◆ Click Cancel to exit from this page without saving the changes.

## 4.11 QoS

You can view QoS on the left navigation bar of the NV-600AI CPE homepage. The menu below includes the sub-menus of **QoS Settings**, **Queue Config** and **Class Config**. Following are the options available under QoS as shown in [Figure 4.11](#)

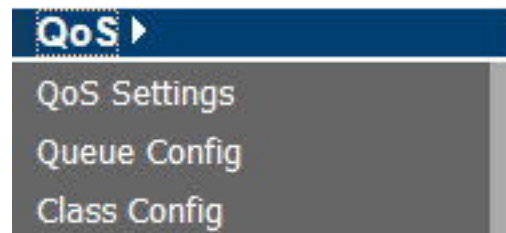

**Figure 4.11 QoS Options**

### 4.11.1 QoS Settings

To configure the Quality of Service (QoS) Settings, click the **QoS Settings** link (**QoS > QoS Settings**) on the left navigation bar. A screen is displayed as shown in [Figure 4.11.1](#)

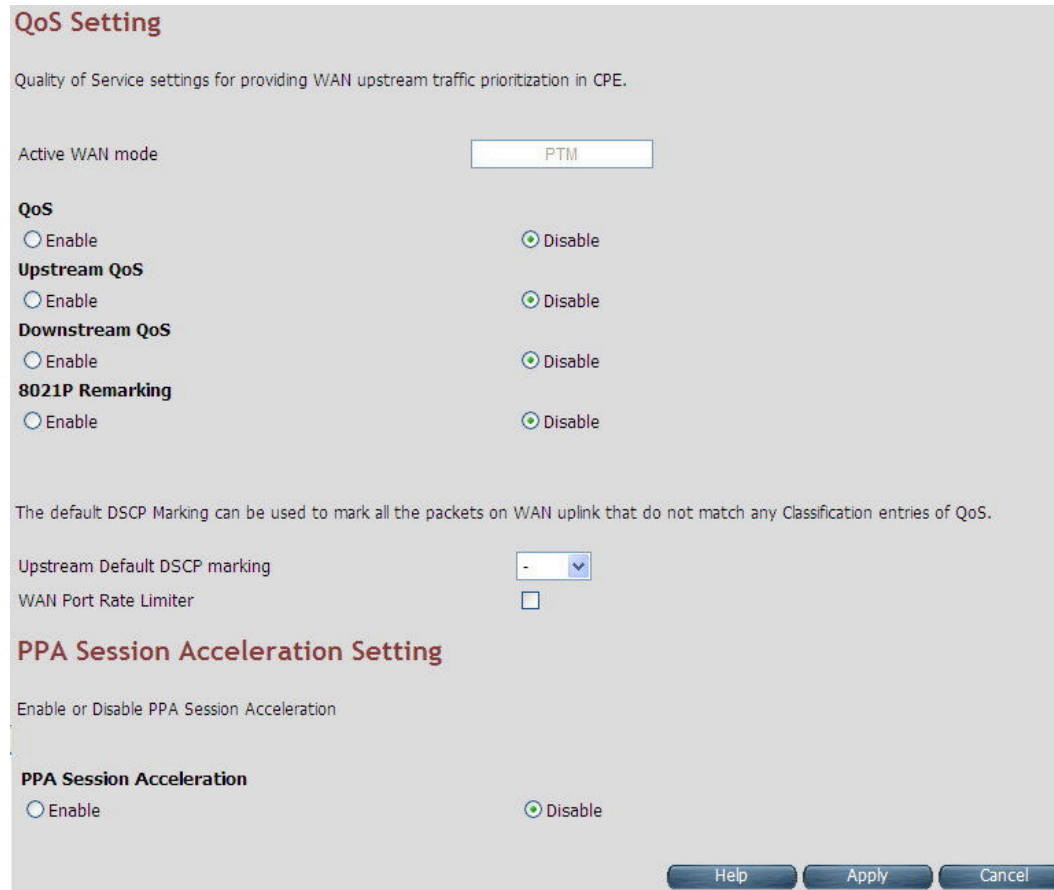

**Figure 4.11.1 QoS Settings**

The screen contains the following details:

**Fields in QoS Settings:**

Field	Description
Active WAN mode	Informative Parameter to show current WAN mode being used in CPE.
QoS	
Enable	This selection will enable the QoS feature in NV-600AI system.
Disable	This selection will disable the QoS feature in NV-600AI system.
Upstream QoS	
Enable	This selection will enable the upstream QoS.
Disable	This selection will disable the upstream QoS.
Downstream QoS	
Enable	This selection will enable the downstream QoS.
Disable	This selection will disable the downstream QoS.
8021P Remarking	
Enable/Disable	This will enable/disable global 8021P Remarking.
Upstream Default DSCP Marking	Default DSCP Marking for non-classified packets. By default it is "No Change" for these non-classified (default) traffic flows.
WAN Port Rate Limiter	Check-box for limiting physical port rate limit on WAN upstream link.
PPA Session Acceleration Setting	
PPA Session Acceleration	To enable/disable the session acceleration feature.

- ◆ Click Apply for applying the QoS setting changes into system.
- ◆ Click CANCEL to exit from this page without saving the changes.

### 4.11.2 Queue Config

To configure the Queue Config, click the **Queue Config** link (**QoS > Queue Config**) on the left navigation bar. A screen is displayed as shown in [Figure 4.11.2](#)

## WAN Egress Queue Configuration

Configure queues in CPE device to be used for QoS controlled traffic flows. The queue entries configured here will be used by classifier to place packets appropriately.

UPSTREAM
DOWNSTREAM

Queue Name	Queue Precedence	Drop Algorithm	Schedule Algorithm	Queue Weight	Committed Shaping Rate	Peak Shaping Rate	Enable	Action
def_queue	8	DT	SP	0	0	60000	Yes	<input type="radio"/>
q1	1	DT	SP	0	0	60000	Yes	<input type="radio"/>
q2	2	DT	SP	0	0	60000	Yes	<input type="radio"/>

Add
Delete
Modify
Help

**Figure 4.11.2 Queue Config**

The screen contains the following details:

**Fields in Queue Config - Upstream:**

Field	Description
Upstream/Downstream	Selection tab for upstream/downstream Queue configuration.
Queue Name	This is the name of the queue configured in system.
Queue Precedence	Precedence of Queue. (Lower values denote higher priority).
Drop Algorithm	This specifies the nature of drop in case of congestion. The supported drop algorithms are DT (Drop Tail) or RED (Random Early Discard).
Scheduler Algorithm	This is the queue scheduling algorithm used for the queue. The supported queue scheduling algorithms are SP (Strict Priority) or WFQ (Weighted Fair Queuing).
Queue Weight	Valid for Weighted Queuing mode of scheduled queues.
Committed Shaping Rate	Committed or Guaranteed Shaping Rate in Kbps or Percentage.
Peak Shaping Rate	Peak or Maximum shaping rate (ceiling) in Kbps or Percentage.
Enable	This provides the status of queue entry. (Enabled or Disabled).
Action	Selection button for applying Modify or Delete action on selected queue.
Add	This button is used to add a new queue.
Delete	This button is used to delete the selected queue entry.
Modify	This button is used to modify the selected queue entry.

When you click Add button in the Port Triggering page, a screen is displayed as shown in [Figure 4.11.2.1](#).

### Add/Modify a WAN Egress Queue Entry

Queue Name	<input type="text"/>
Queue Interface	WAN ▾
Queue Precedence	1 ▾
Queue Drop Type	RED ▾
RED Min Threshold	<input type="text"/>
RED Max Drop Probability	<input type="text"/>
Queue Scheduler Type	Strict Priority ▾
Queue Weight	<input type="text" value="0"/>
Apply Shaping	<input type="checkbox"/>
Enable	<input type="checkbox"/>

**Figure 4.11.2.1 Add/Modify a Queue Entry**

The screen contains the following details:



**Fields in Add/Modify a Queue Entry:**

Field	Description
Queue Name	Name or Identifier of Queue.
Queue Interface	This is the Egress interface to which the queue is attached. For xRX200 platform the dropdown for LAN egress would also appear. This indicates downstream QoS (WAN to Ethernet LAN) is supported on xRX200 platforms.
Queue Precedence	Precedence of Queue. (Lower values denote higher priority).
Queue Drop Type	Drop Algorithm of Queue (DT [Drop Tail] or RED [Random Early Discard]).
RED Min Threshold	RED Threshold Value, applicable for RED Drop algo.
RED Max Drop Probability	RED Maximum Drop Probability in Percentage (drop_p). Value should be <100.
Queue Scheduler Type	Queue scheduling Algorithm. (SP or WFQ)
Queue Weight	Valid for Weighted Queuing mode of scheduled queues.
Apply Shaping	To apply shaping on queue.
Enable	Enable or Disable of Queue.

- ◆ Click Apply for applying the changes.
- ◆ Click CANCEL to exit from this page without saving the changes.

### 4.11.3 Class Config

To classify the upstream traffic. Click the **Class Config** link (**QoS > Class Config**) on the left navigation bar. A screen is displayed as shown in [Figure 4.11.3](#)

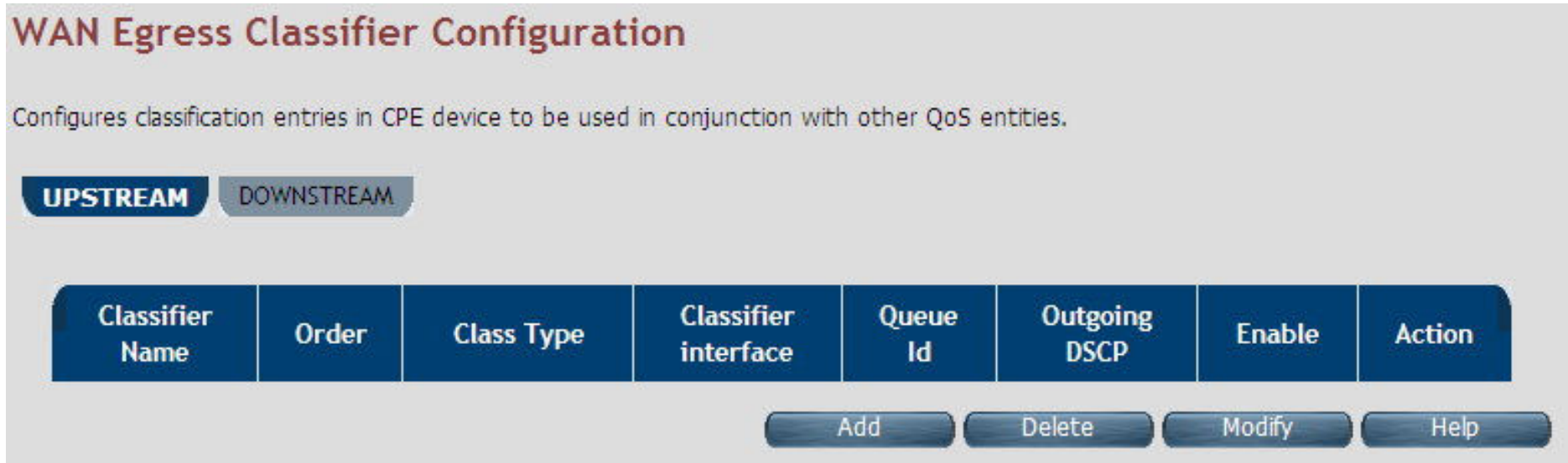

**WAN Egress Classifier Configuration**

Configures classification entries in CPE device to be used in conjunction with other QoS entities.

**UPSTREAM**
 DOWNSTREAM

Classifier Name	Order	Class Type	Classifier interface	Queue Id	Outgoing DSCP	Enable	Action
-----------------	-------	------------	----------------------	----------	---------------	--------	--------

**Figure 4.11.3 Class Config**

The screen contains the following details:

**Fields in Class Config:**

Field	Description
Upstream/Downstream	Selection tab for upstream/downstream Classifier configuration.
Classifier Name	This is the name or identifier of the classifier entry.
Order	This shows the order of the classification entry.
Class Type	Type of Classifier - Multi Field Classifier (MFC) or DSCP or 802.1p based.
Classifier Interface	This is a Packet Input Source for classified flow.
Queue Id	Queue Id for classified flow.
Outgoing DSCP	This is the DSCP mark for next hop.
Enable	Status of Classification entry.
Action	Selection option for deleting or modifying action on chosen classifier.
Add	This is the button used to add a classification entry to categorize a traffic flow.
Delete	Delete button for deleting selected queue.
Modify	Modify button for modifying chosen queue.

When you click Add or Modify in the Classifier Config page, a screen is displayed as shown in [Figure 4.11.3.1](#)



**Add/Modify a WAN Egress Classifier Rule**

Classifier Name	<input type="text"/>
Enable	<input type="checkbox"/>
Disable Acceleration	<input type="checkbox"/>
Queue Name	def_queue ▾
Classifier Interface	Upstream ▾
Ingress Interface	- ▾
Classifier Type	DSCP Based ▾
Rate Control Enable	<input type="checkbox"/>
Rate Limit	<input type="text"/> Kbps
Outgoing DSCP	- ▾
Incoming DSCP	CS0 ▾

Help Apply Cancel

**Figure 4.11.3.1 Add/Modify a Classifier Rule (DSCP Based)**

Classifier Type	MFC Based		
Rate Control Enable	<input type="checkbox"/>		
Rate Limit	<input type="text"/>	Kbps	
Outgoing DSCP	-		
Incoming DSCP	-		
Incoming 802.1P	-		
Outgoing 802.1P	-		
VLAN Id	<input type="text"/>		<input type="checkbox"/> Exclude
Source MAC	<input type="text"/>	Source MAC Mask <input type="text"/>	<input type="checkbox"/> Exclude
Destination MAC	<input type="text"/>	Destination MAC Mask <input type="text"/>	<input type="checkbox"/> Exclude
L3 Protocol	IPv4		<input type="checkbox"/> Exclude
Source IP	<input type="text"/>	Netmask <input type="text"/>	<input type="checkbox"/> Exclude
Destination IP	<input type="text"/>	Netmask <input type="text"/>	<input type="checkbox"/> Exclude
L4 Protocol	<input type="text"/>		<input type="checkbox"/> Exclude
Source Port (range)	<input type="text"/>	~ <input type="text"/>	<input type="checkbox"/> Exclude
Destination Port (range)	<input type="text"/>	~ <input type="text"/>	<input type="checkbox"/> Exclude
Order	Last		

**Figure 4.11.3.1 Add/Modify a Classifier Rule(MFC Based)**

The screen contains the following details:

**Fields in Add/Modify a Classifier Rule:**

<b>Field</b>	<b>Description</b>
Classifier Name	This is the name of Classifier. This is an Unique identifier for an instance of classifier rule.
Enable	This is used to enable or disable the QoS Classifier entry.
Classifier Interface	This is used to select upstream/downstream classifier.
Disable acceleration	This is used to disable acceleration for this classifier.
Queue Name	This is the Queue Identifier to be associated with this classifier rule. This is presented in dropdown for associating with this classifier entry.
Ingress Interface	Packet Input Source for classified flow.
Classifier Type	Type of Classifier - Multi Field Classifier (MFC) or DSCP or 802.1p based.
Rate Control Enable	Configuration of classifier based rate control.
Rate Limit	Rate limit per classifier.
Outgoing DSCP	Outgoing DSCP Marking - if any to be done on this classifier rule.
Incoming DSCP	Incoming DSCP for identifying the flow.
Incoming 802.1P	Incoming 802.1P for identifying the flow.
Outgoing 802.1P	Outgoing 802.1P Marking - if any to be done on this classifier rule.
VLAN Id	Incoming VLAN id.
Source MAC	Source MAC classification.
Source MAC Mask	Mask bits for Source MAC.
Destination MAC	Destination MAC classification.

Destination MAC Mask	Mask bits for Destination MAC.
L3 Protocol	Dropdown to select IPv4/IPv6.
Source IP	Source IPv4/IPv6 classification.
Netmask	Mask bits for Source IP.
Destination IP	Destination IPv4/IPv6 classification.
Netmask	Mask bits for Source IP.
L4 Protocol	Dropdown to select L4 protocol like UDP/TCP/ICMP etc.
Source Port Range	Start and end source port range.
Destination Port Range	Start and end destination port range.
Order	Classification order.

- ◆ Click Apply for applying the changes.
- ◆ Click CANCEL to exit from this page without saving the changes.

## 4.12 Multicast

You can view Multicast on the left navigation bar of the NV-600AI CPE homepage. The menu below includes the sub-menus of **Proxy Settings**, **Snooping Settings** and **Advanced Settings**. Following are the options available under Multicast as shown in [Figure 4.12](#)

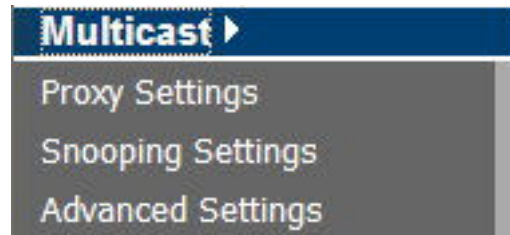
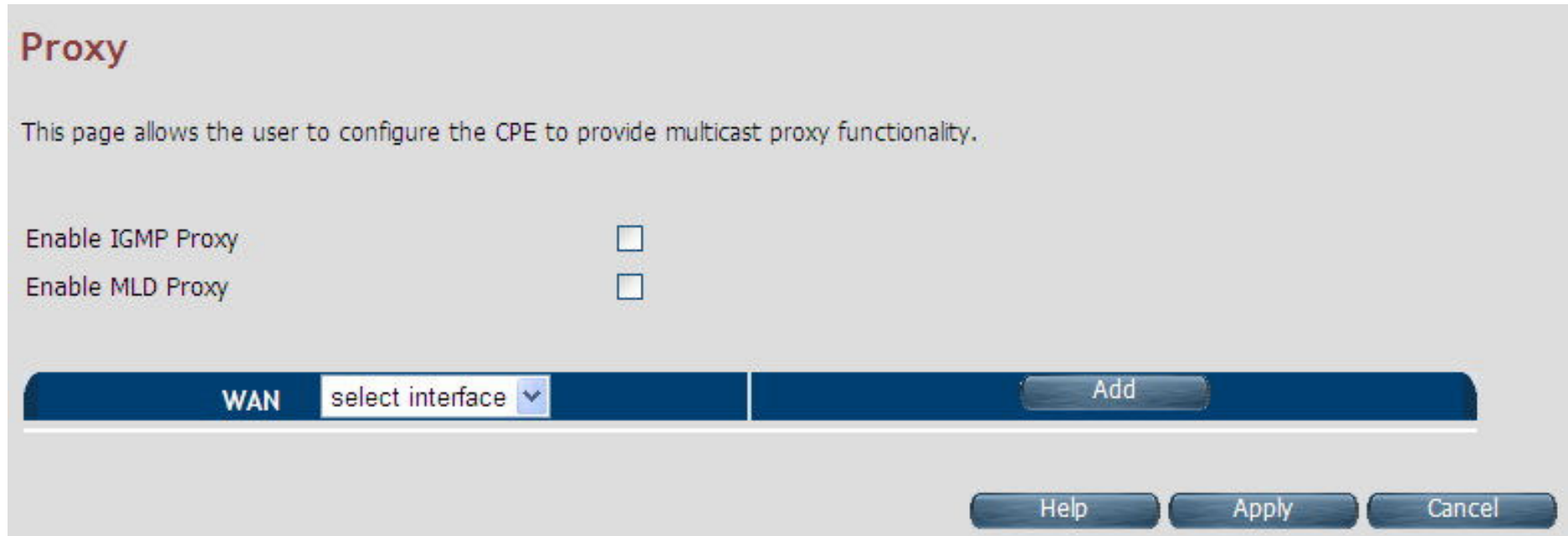

**Figure 4.12 Multicast Options**



### 4.12.1 Proxy Settings

To configure the Multicast proxy settings in CPE, click the **Proxy Settings** link (**Multicast > Proxy Settings**) on the left navigation bar. A screen is displayed as shown in [Figure 4.12.1](#)



**Figure 4.12.1 IGMP Proxy**

The screen contains the following details:

**Fields in IGMP Proxy:**

Field	Description
Enable IGMP Proxy	Enable or Disable the IGMPv3/IGMPv2 Proxy functionality.
Enable MLD Proxy	Enable or Disable the MLDv2 (IPv6) Proxy functionality.
WAN	Select one of the WAN interfaces from the drop-down menu on which Multicast Proxy functionality to be enabled.
Add	Add an IGMP proxy configuration.

- ◆ Click Apply at any time during configuration to save the information that you have entered.
- ◆ Click CANCEL to exit from this page without saving the changes.

### 4.12.2 Snooping Settings

To configure the Multicast Snooping settings, click the **Snooping Settings** link (**Multicast > Snooping Settings**) on the left navigation bar. A screen is displayed as shown in [Figure 4.12.2](#)

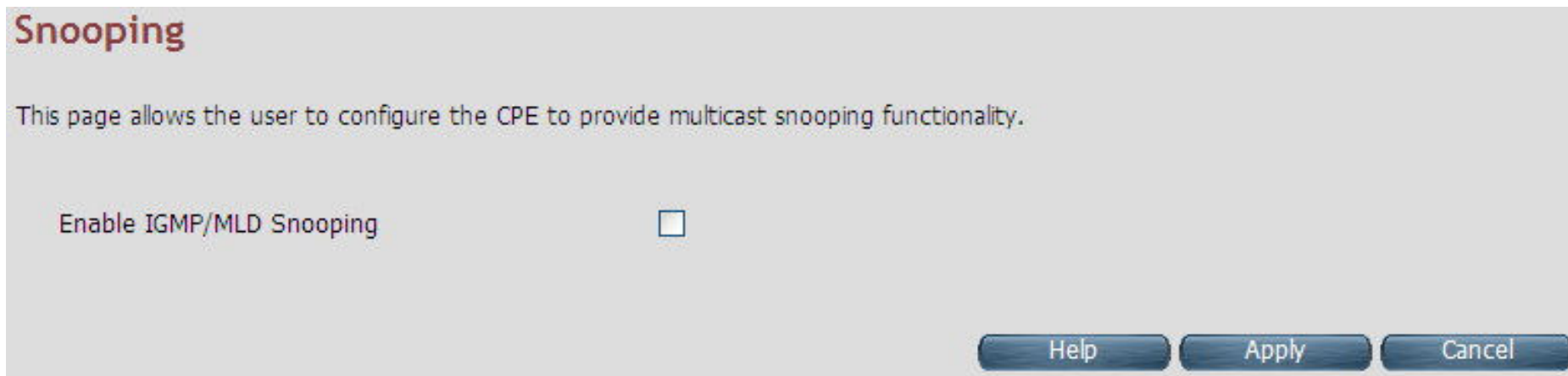

**Figure 4.12.2 IGMP Snooping**

The screen contains the following details:

**Fields in Fields in Snooping:**

Field	Description
Enable IGMP Snooping	Enable or Disable the IGMPv3/IGMPv2 Snooping functionality.
Enable MLD Snooping	Enable or Disable the MLDv2 (IPv6) Snooping functionality.

- ◆ Click Apply at any time during configuration to save the information that you have entered.
- ◆ Click CANCEL to exit from this page without saving the changes.

### 4.12.3 Advanced Settings

To configure the advanced settings on Multicast features, click the **Advanced Settings** link (**Multicast > Advanced Settings**) on the left navigation bar. A screen is displayed as shown in [Figure 4.12.3](#)

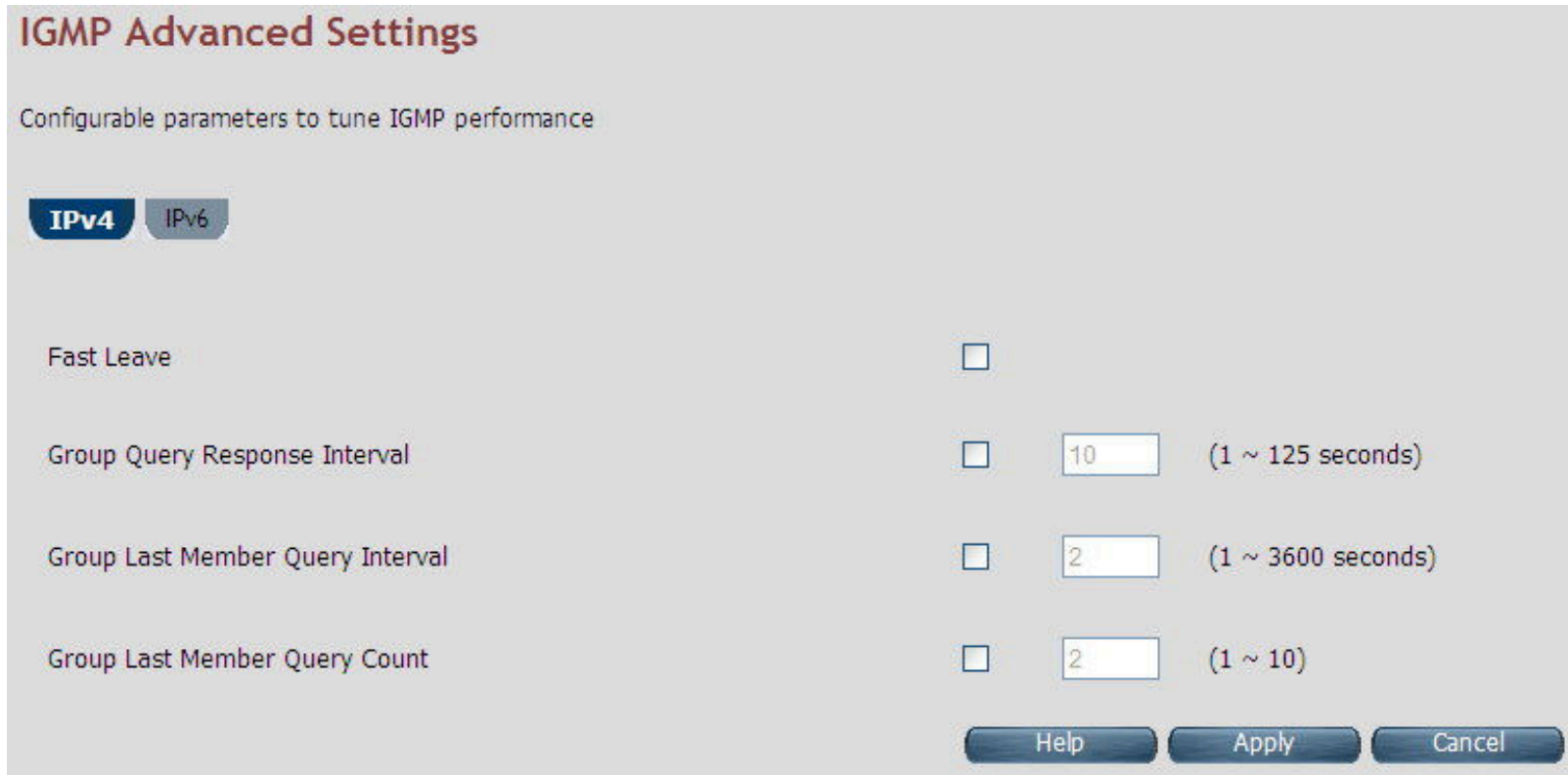

**IGMP Advanced Settings**  
Configurable parameters to tune IGMP performance

**IPv4** IPv6

Fast Leave

Group Query Response Interval  10 (1 ~ 125 seconds)

Group Last Member Query Interval  2 (1 ~ 3600 seconds)

Group Last Member Query Count  2 (1 ~ 10)

Help Apply Cancel

**Figure 4.12.3 Multicast Advanced Settings**

The screen contains the following details:

**Fields in Multicast Advanced Settings:**

Field	Description
IPv4/IPv6	Choose the appropriate tab to configure either for IPv4 or IPv6.
Fast Leave	To enable or disable Fast-Leave support in IGMPv3/IGMPv2. The fast-leave is not to wait till group membership timers on multicast routers have expired, but quickly send a group-specific query and if not report were received, remove the group entry.
Group Query Interval	Specify Group Query Interval in range of 1-3600 seconds.
Group Query Response Interval	Specify Group Query Response Interval in range of 1-3600 seconds.
Group Last Member Query Interval	Group Last Member Query Interval in range of 1-3600 seconds.
Group Last Member Query Count	Group Last Member Query Count in range of 1 to 10.

**Tip:**

**Similar settings are available for MLDv2 under IPv6 tab.**

## 4.13 IPsec

When you click IPsec on the left navigation bar of the NV-600AI CPE homepage. The menu below includes the sub-menus of **Tunnel Mode**. The following option Tunnel Mode is available under IPsec as shown in [Figure 4.13](#)



**Figure 4.13 IPsec Option**

### 4.13.1 Tunnel Mode

When you click the **Tunnel Mode** link (**IPsec > Tunnel Mode**) on the left navigation bar, a screen is displayed as shown in [Figure 4.13.1](#)

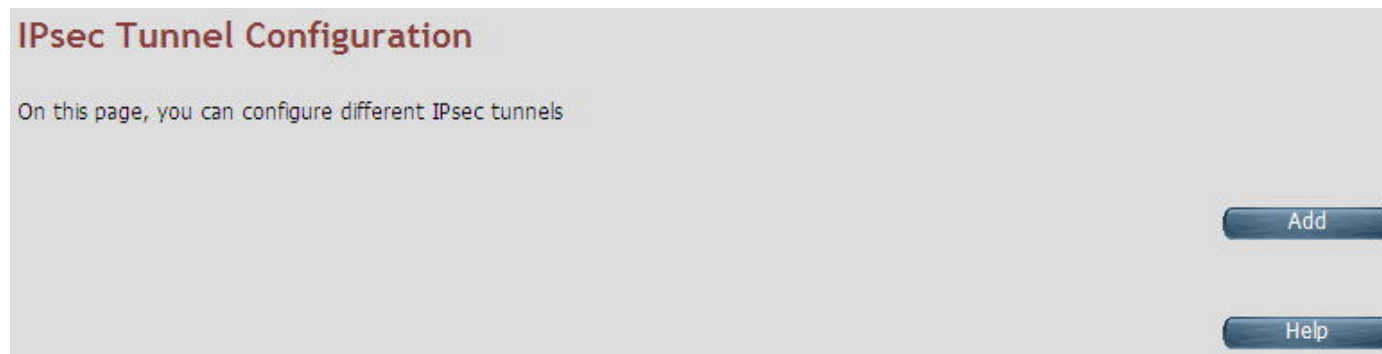

**Figure 4.13.1 IPsec Tunnel Configuration**

When you click Add button in the IPsec Tunnel Configuration page, a screen is displayed as shown in [Figure 4.13.1.1](#)

**Add IPsec Tunnel Configuration**

Tunnel Name

AUTH\_METHOD

PSK Secret

IKE Mode

WAN Interface

My Subnet  .  .  .  /

Peer Address  .  .  .

Peer Subnet  .  .  .  /

Enable

IKE Cipher

IKE Hash

IKE DH Group

IKE PRF

ESP Cipher

ESP Hash

Key Lifetime  (Minutes)

Retry  (0 means always retry)

**Figure 4.13.1.1 Add IPsec Tunnel Mode Configuration**

The screen contains the following details:

**Fields in Add IPsec Add Configuration:**

Field	Description
Tunnel Name	IPsec Tunnel name
AUTH_METHOD	This is the authentication method.
PSK Secret	Shared secret string used for tunnel authentication.
IKE Mode	IKE v1 or v2 algorithm
WAN Interface	WAN on which tunnel to be created.,
My Subnet	LAN host connected to CPE.
Peer Address	Remote tunnel end point address.
Peer Subnet	Remote host IP address.
Enable	Enable or Disable of tunnel.
IKE Cipher	Cipher algorithm to be selected from dropdown.
IKE Hash	Hash algorithm to be selected from dropdown.
IKE DH Group	DH group algorithm to be selected from dropdown.
IKE PRF	PRF algorithm to be selected from dropdown.
ESP Cipher	ESP Cipher algorithm to be selected from dropdown.
ESP Hash	ESP Hash algorithm to be selected from dropdown.
Key Lifetime	Key Lifetime in seconds.
Retry	Number of retries in case key exchange fails.

- ◆ Click Apply for applying the configured IPsec tunnel.
- ◆ Click CANCEL to exit from this page without saving the changes.



## 4.14 IPv6

When you click IPv6 link on the left navigation bar of the NV-600AI CPE homepage. The menu below includes the sub-menus of **IPv6 Setting**, **6RD Configuration** and **DS-Lite Configuration**. The following options are available as shown in [Figure 4.14](#)

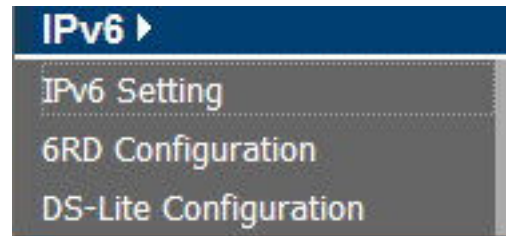

**Figure 4.14 IPV6 Options**

### 4.14.1 IPv6 Setting

To enable or disable IPv6 functionality in CPE, click the **IPv6 Setting** link on the left navigation bar. A screen is displayed as shown in [Figure 4.14.1](#). By default IPv6 is not enabled.

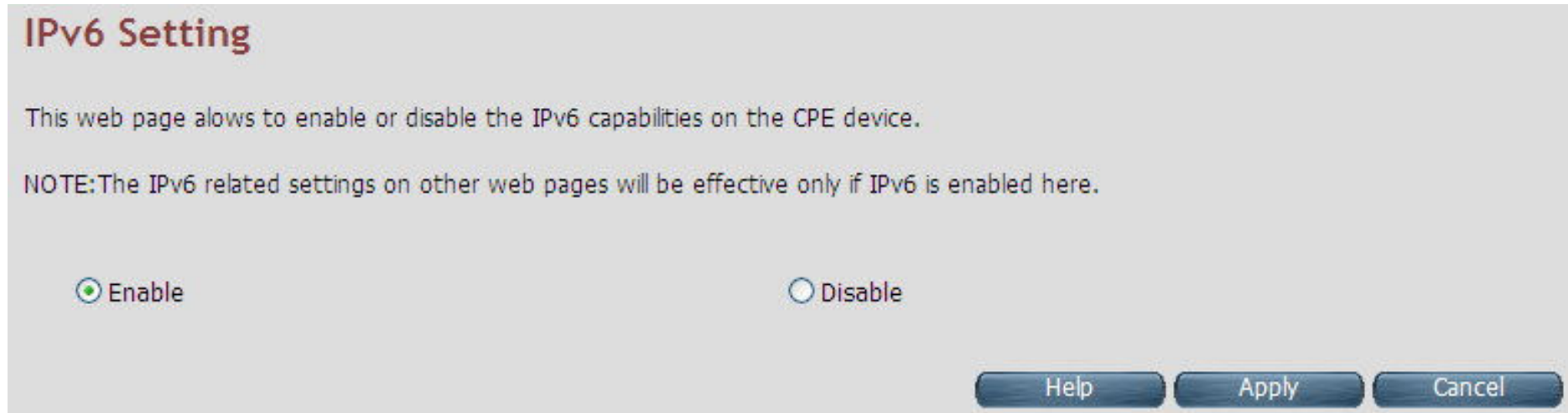

**Figure 4.14.1 IPv6 Setting**

The system wide IPv6 feature can be enabled or disabled through this web page. Select appropriate control and click Apply button for making the change effective in CPE. All other IPv6 features in CPE would be in effect, only when this global IPv6 is enabled in CPE.

**Fields in IPv6 Setting:**

IPv6 Setting	
Enable	Enable IPv6 functionality in CPE.
Disable	Disable IPv6 functionality in CPE.

- ◆ Click Apply at any time during configuration to save the information that you have entered.
- ◆ Click CANCEL to exit from this page without saving the changes.

### 4.14.2 6RD Configuration

The NV-600AI supports IPv6 transition mechanism defined in 6rd (RFC 5569). To configure the 6RD configuration, click the **6RD configuration** link (**IPv6 > 6RD Configuration**) on the left navigation bar. A screen is displayed as shown in [Figure 4.14.2](#)

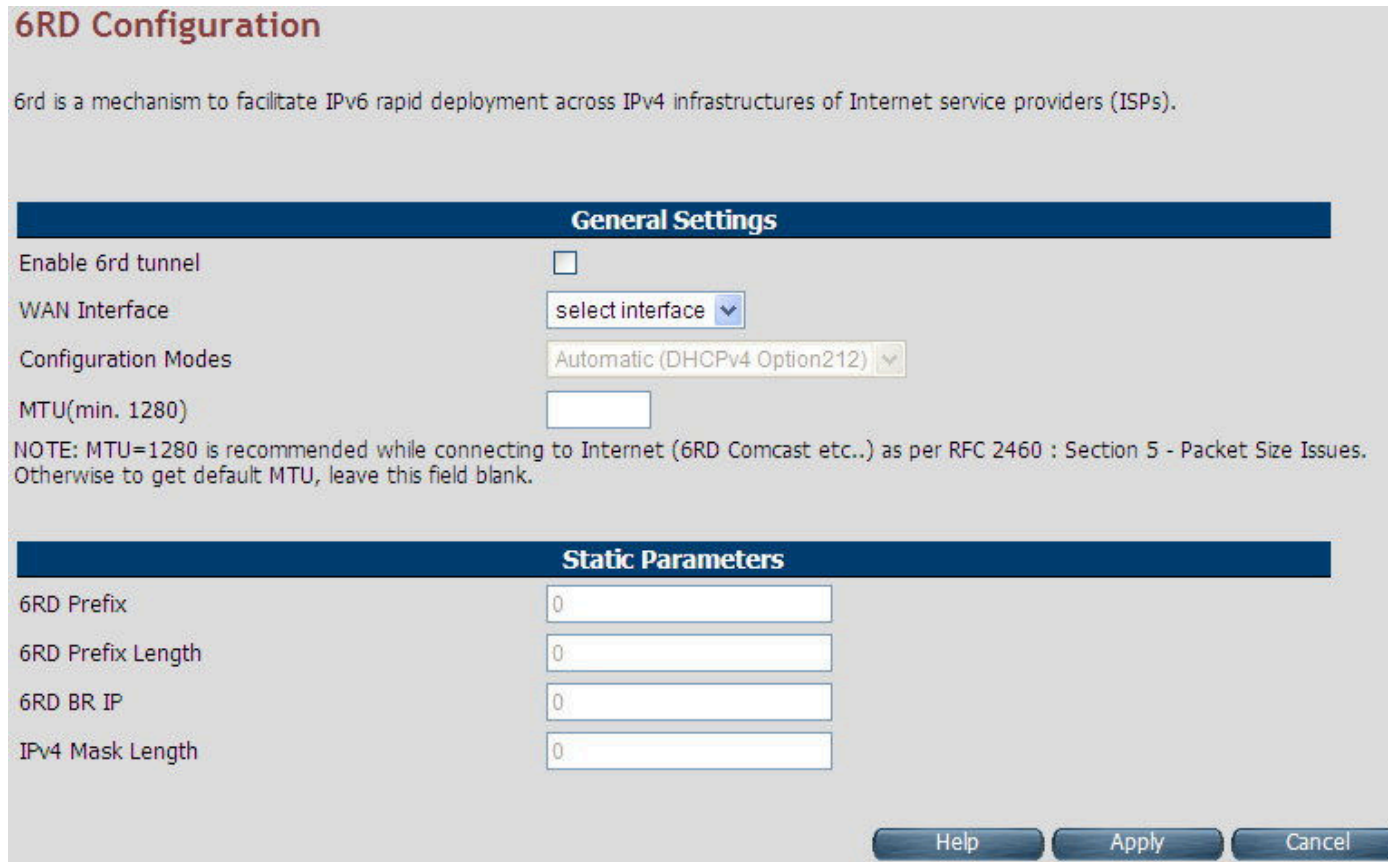

**6RD Configuration**

6rd is a mechanism to facilitate IPv6 rapid deployment across IPv4 infrastructures of Internet service providers (ISPs).

**General Settings**

Enable 6rd tunnel

WAN Interface

Configuration Modes

MTU(min. 1280)

NOTE: MTU=1280 is recommended while connecting to Internet (6RD Comcast etc..) as per RFC 2460 : Section 5 - Packet Size Issues. Otherwise to get default MTU, leave this field blank.

**Static Parameters**

6RD Prefix

6RD Prefix Length

6RD BR IP

IPv4 Mask Length

Help Apply Cancel

**Figure 4.14.2 6RD Configuration**

The screen contains the following details:

**Fields in 6RD Configuration:**

Field	Description
General Settings	
Enable 6rd tunnel	To enable or disable 6rd functionality in CPE.
WAN Interface	Select WAN interface form dropdown on which 6rd tunnel to be created.
Configuration Modes	Select dynamic 6rd tunnel through DHCP option or static tunnel configuration.
MTU (min. 1280)	Optionally, you can specify Maximum Transfer Unit size for 6rd tunnel.
Static Parameters	
6Rd Prefix	6RD Prefix string.
6RD Prefix Length	6RD Prefix Length.
6RD BR IP	6RD Broder Relay's IPv4 address.
IPV4 Mask Length	IPv4 address Mask Length.

- ◆ Click Apply at any time during configuration to save the information that you have entered.
- ◆ Click CANCEL to exit from this page without saving the changes.

### 4.14.3 DS-Lite Configuration

The NV-600AI supports DS-Lite configuration mechanism. To configure the Ds-Lite configuration, click the **DS-Lite** configuration link (**IPv6 > DS-Lite Configuration**) on the left navigation bar. A screen is displayed as shown in [Figure 4.14.3](#)

#### DS-Lite Configuration

Because of IPv4 address exhaustion, Dual-Stack Lite(DS-Lite) was designed to let an Internet service provider omit the deployment of any IPv4 address to the customer's Customer-premises equipment (CPE). Instead, only global IPv6 addresses are provided.

Note: To configure DS-Lite on a WAN connection, IPv6 must be enabled at IPv6 Setting page and native IPv6 must be enabled on that WAN connection at WAN Setting page.

General Settings

Enable DS-Lite tunnel

WAN Interface select interface ▼

Configuration Modes Static DS-Lite ▼

MTU  (optional)

Static Parameters

DS-Lite Remote IPv6 address

DS-Lite tunnel IP address(IPv4)

Subnet Mask

Lw4o6 Port Range(Valid 0 to 65535 Ex:40000-41000)

WAN interface	Configuration Mode	Remote IPv6 address	Tunnel IP(IPv4)	Netmask	Status

Help
Apply
Cancel

**Figure 4.14.3 DS-Lite Configuration**

The screen contains the following details:

**Fields in DS-Lite Configuration:**

Field	Description
General Settings	
Enable DS-Lite tunnel	To enable/disable DS-Lite functionality in CPE.
WAN Interface	Select WAN interface from dropdown on which DS-Lite tunnel has to be created.
Configuration Modes	Modes to configure DS-Lite tunnel on a WAN interface. Currently, Static, Dynamic(DHCPv6 option-64) and Lw4o6 DS-Lite modes are supported.
MTU	Optionally, it is used to specify Maximum Transfer Unit size for DS-Lite tunnel.
Static Parameters	
DS-Lite Remote IPv6 address	IPv6 address of the remote tunnel endpoint. (When you select Dynamic mode, this field is disabled.)
DS-Lite tunnel IP address (IPv4)	IPv4 address of the remote tunnel endpoint.
Subnet Mask	IPv4 Address subnet mask.
Lw4o6 Port Range	This is the port range for Source NAT.Applicable only for Lw4o6 type.

- ◆ Click Apply at any time during configuration to save the information that you have entered.
- ◆ Click CANCEL to exit from this page without saving the changes.

## 4.15 Diagnostics

When you click Diagnostics link on the left navigation bar of the NV-600AI CPE homepage. The menu below includes the sub-menus of **Diagnostic Test Suite**. The following options are available under Diagnostics as shown in [Figure 4.15](#)

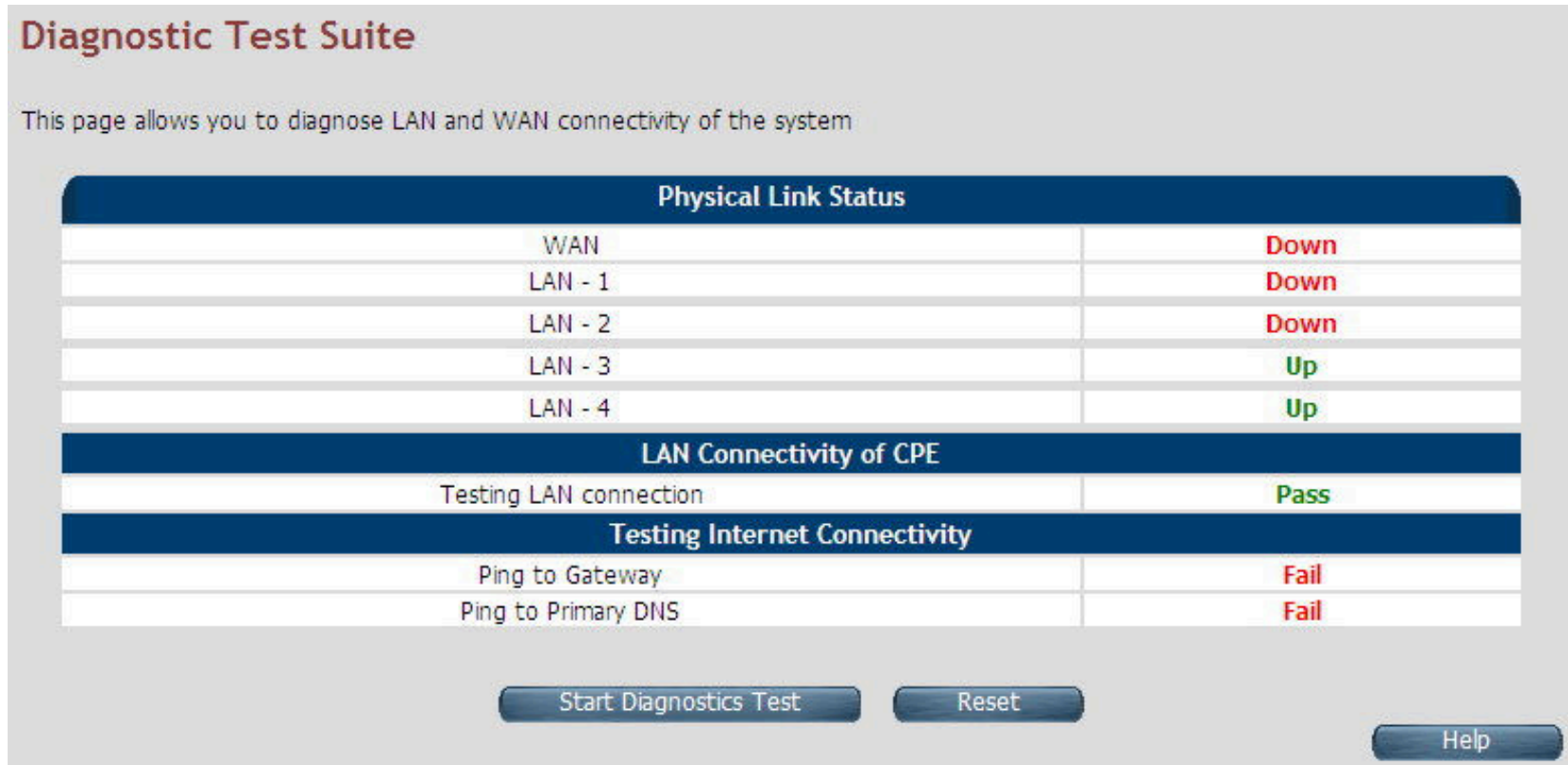

**Figure 4.15 Diagnostics Options**



### 4.15.1 Diagnostic Test Suite

To configure the Diagnostic Test Suite settings, click the **Diagnostic Test Suite** link (**Diagnostics > Diagnostic Test Suite**) on the left navigation bar. A screen is displayed as shown in [Figure 4.15.1](#)



**Figure 4.15.1 Diagnostic Test Suite**

The screen contains the following details:

**Fields in Diagnostic Test Suite:**

Field	Description
Connection Status	
WAN	DSL WAN State
Wireless	Wireless State
ENET LAN-0	Ethernet LAN Port-0 state.
ENET LAN-1	Ethernet LAN Port-1 state
ENET LAN-2	Ethernet LAN Port-2 state
ENET LAN-3	Ethernet LAN Port-3 state
LAN Connectivity of CPE	
Testing LAN Connection	Status of LAN connection Diagnostics
Testing xDSL Connection	
Testing xDSL Synchronization	xDSL Synchronization Test.
Testing ATM Connection on default WAN ATM PVC	
Testing ATM OAM F5 End to End Ping	F5 end to end ping test.
Testing Internet Connectivity	
Ping to Gateway	Ping to Gateway IP address.
Ping to Primary DNS	Ping to Primary DNS IP address.
Start Diagnostics Test	Initiates the Diagnostics test.
Reset	Resets the diagnostics output.

**Note:**

Please wait few seconds to show the test result.

## 4.16 SNMP

You can view SNMP on the left navigation bar of the NV-600A CPE homepage. The menu below includes the sub-menus of **SNMP Settings** and **SNMPv3 Settings**. The following options are available under Diagnostics as shown in [Figure 4.16](#)



**Figure 4.16 SNMP**

Any Network Management platform running the simple Network Management Protocol (SNMP) can manage the router, provided the Management Information Base (MIB) is installed correctly on the management station. The SNMP is a Protocol that governs the transfer of information between management station and agent.

### 4.16.1 SNMP Options

Use this page to define management stations as trap managers and to enter SNMP community strings. User can also define a name, location, and contact person for the router. Fill in the system options data, and then click **Apply** to update the changes on this page.

**SNMP Settings**

SNMP allows management of CPE device from a MIB Browser. For this to work you must enable SNMP Server settings.

Enable SNMP

System Name

System Location

System Contact

Read only community

Read Write community

Enable trap

Trap host IP

Trap port

Trap community

**SNMP Transport**

UDP IPv4  Port

Help Apply Cancel

**Fig. 4.16.1 SNMP Settings**

The screen contains the following details:

**Fields in SNMP Setting:**

IPv6 Setting	
<b>Enable SNMP</b>	Enable/Disable SNMP Function
<b>System Name</b>	Enter a name to be used for the router
<b>System Location</b>	Enter the location of the router
<b>System Contact</b>	Enter the name of a person or organization
<b>RO</b>	Read only. Enables requests accompanied by this string to display MIB-object information.
<b>RW</b>	Read write. Enables requests accompanied by this string to display MIB-object information and to set MIB objects.
<b>Enable Trap</b>	To enable or disable Trap Setting. Select the check box to Enable or Disable the Trap function of NV-600A.
<b>Trap Host IP</b>	Create a trap manager by entering the IP address.
<b>Trap port</b>	Specifies the trap port. Default trap port is "162".
<b>Trap community</b>	Create a trap manager by entering a community string.
<b>SNMP Transport</b>	Specifies the trap port. Default trap port is "161".

- ◆ Click **Apply** at any time during configuration to save the information that you have entered.
- ◆ Click **Cancel** to exit from this page without saving the changes.

### 4.16.2 SNMPv3 Settings

The CPE device provides Security to SNMP access in SNMPv3. You can configure the users to have Authorized access to SNMP data. When you click **Add** inside the **SNMPv3 Settings**, a screen is displayed as shown in [Figure 4.16.2](#)

SNMPv3 Settings

The cpe device provides Security to SNMP access in SNMPv3. You can configure the users to have Authorized access to SNMP data.

	User Name	User Access	Security Level	Authorization Protocol	Privacy Protocol	
1	defUser	Read-Write	Auth,Priv	MD5	DES	Delete

**Fig. 4.16.2 SNMPv3 Settings**

### 4.16.3 Add v3 user

Add a v3 user

User Access  Read-Only  Read-Write

User Name

Security Level Authorization, No Privacy ▾

Authorization Protocol MD5 ▾ Auth Password(8~15 char.)

Privacy Protocol DES ▾ Privacy Password(8~15 char.)

HELP APPLY CANCEL

**Fig. 4.16.3 SNMP Setting**

The screen contains the following details:

**Fields in Add a V3 user Setting:**

<b>IPv6 Setting</b>	
<b>User Access</b>	specifies the user Access.
<b>User Name</b>	specifies the user name.
<b>Security Level</b>	specifies the Security level.
<b>Authorization Protocol</b>	specifies the authorization type.(MD5/DES)
<b>Auth Password</b>	specifies the authorization key.(8~15 chars)
<b>Privacy Protocol</b>	specifies the privacy type.(MD5/DES)
<b>Privacy Password</b>	specifies the encrypt key.(8~15 chars)

- ◆ Click Apply at any time during configuration to save the information that you have entered.
- ◆ Click CANCEL to exit from this page without saving the changes.



## **Appendix A: Cable Requirements**

### **A.1 Ethernet Cable**

A CAT 3~7 UTP (unshielded twisted pair) cable is typically used to connect the Ethernet device to the router. A 10Base-T cable often consists of four pairs of wires, two of which are used for transmission. The connector at the end of the 10Base-T cable is referred to as an RJ-45 connector and it consists of eight pins. The Ethernet standard uses pins 1, 2, 3 and 6 for data transmission purposes. (Table A-1)

**Table A-1** RJ-45 Ethernet Connector Pin Assignments

PIN #	MDI		MDI-X	
	Signal	Media Dependant interface	Signal	Media Dependant interface-cross
1	TX+	Transmit Data +	RX+	Receive Data +
2	TX-	Transmit Data -	RX-	Receive Data -
3	RX+	Receive Data +	TX+	Transmit Data +
4	--	Unused	--	Unused
5	--	Unused	--	Unused
6	RX-	Receive Data -	TX-	Transmit Data -
7	--	Unused	--	Unused
8	--	Unused	--	Unused

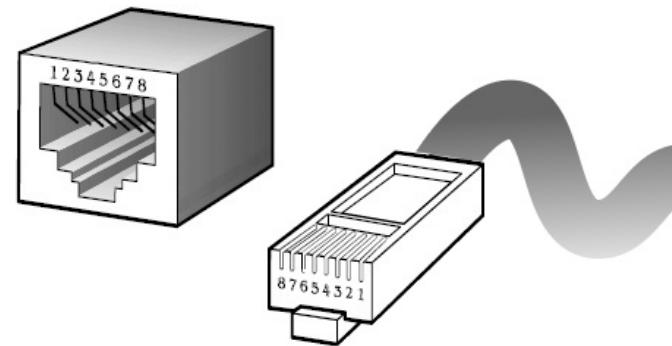

**Figure A-1** Standard RJ-45 repeater/connector

**Note:**

Please make sure your connected cables are with same pin assignment as above table before deploying the cables into your network.

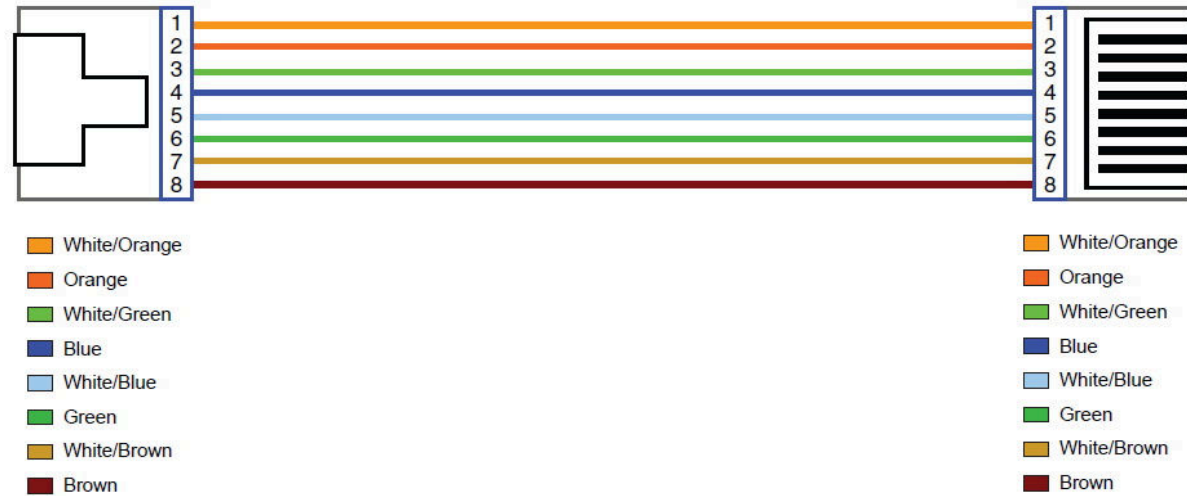

**Figure A-2 Pin Assignments and Wiring for an RJ-45 Straight-Through Cable**



**Figure A-3 Pin Assignments and Wiring for an RJ-45 Crossover Cable**

**A.2 Telephone wire**

Standard telephone wire of any gauge or type-flat, twisted or quad is used to connect the Modem to the telephone network. A telephone cable typically consists of three pairs of wires, one of which is used for transmission. The connector at the end of the telephone cable is called an RJ-11 connector and it consists of six pins. POTS (plain old telephone services) use pins 3 and 4 for voice transmission. A telephone cable is shown below. (Figure A-6)

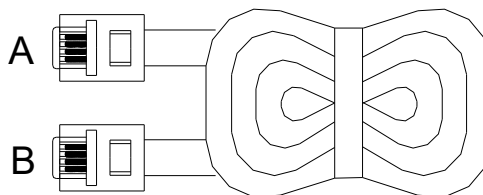

**Figure A-4 Telephone cable**

The A and B connectors on the rear of the Modem are RJ-11 connectors. These connectors are wired identically. The RJ-11 connectors have six positions, two of which are wired. The Modem uses the center two pins. The pin out assignment for these connectors is presented below. (Table A-3)

**Table A-3 RJ-11 Pin out Assignments**

Pin#	MNEMONIC	FUNCTION
1	NC	Unused
2	NC	Unused
3	<b>TIP</b>	<b>POTS</b>
4	<b>RING</b>	<b>POTS</b>
5	NC	Unused
6	NC	Unused_

## **Appendix B: Product Specification**

### **Key Features & Benefits**

- ◆ Support ATM and PTM transmission mode auto detection( ADSL Annex B backward compatible)
- ◆ Supports high bandwidth up to 100Mbps symmetric over line ports
- ◆ Support 8a, 8b, 8c, 8d, 12a, 12b, 17a, 17b, and 30a band profile and 997, 998 band plan
- ◆ Support ATM-TC,ATM and AAL5 (ATM Flow Throughput / OAM Cell Filter and Forwarding / AAL5 SAR:PVC / ATM Traffic Class / ATM PVC Shaping / ATM PVC Scheduling)
- ◆ Supports ATM Total Upstream Priority Queues
- ◆ Support uPnP/PPPoE/PPPoATM/IPv4/IPv6/NAT/NAPT
- ◆ Support static routing for IPv4 and IPv6 forwarding
- ◆ Support Firewall functions contains Packet filtering, DMZ, Mac Address based filtering, Parental Control, Application based filtering
- ◆ Support DHCP Server/DHCP Relay/DHCP Client/DHCPv6 Client/DHCPv6 Server/DNS/ DNS Proxy or Relay/DNSv6 Proxy or Relay/NTP Client/HTTP1.1 server
- ◆ Support Multicast IP table/IGMP v3 Proxy and Snooping
- ◆ Support Router & Switch(Bridged) mode
- ◆ Support IEEE 802.1p VLAN Priority and mapping to DSCP
- ◆ Supports 802.1q Tag Vlan
- ◆ Support HTTP/HTTPS(SSL) web management
- ◆ Support remote management and monitor
- ◆ Support configuration backup and restore
- ◆ Provides surge protection for Line port

- ◆ Support power redundant and wide range dual power input(DC12V ~ 48V)
- ◆ Supports Overload Current Protection
- ◆ Supports wide range operating temperature(-20 C ~ 70 C)
- ◆ Supports Reverse Polarity Protection
- ◆ Supports alarm contact (relay output - 1 A @ 24 VDC)
- ◆ Supports DIN-Rail mount installation
- ◆ Metal case design and compliant with IP30 standard
- ◆ Support Router & Switch(Bridged) mode selection
- ◆ Supports Dual Firmware Image Backup
- ◆ Supports Dying Gasp
- ◆ Supports ATM OAM F4 & F5
- ◆ Supports SNMP v1 / v2c / v3

**Note:**

1. Features and specifications in this manual are subject to change without prior notice.
2. (\*) Firmware upgradeable for future enhancement.

## Product Specification

<b>Standard:</b>	IEEE802.3/802.3u/802.3ab standards ITU-T G992.1/G992.3/G992.5/G993.1/G997.1/G993.2 standards
<b>Physical Interface:</b>	4 x RJ-45 10/100/1000 Mbps Ethernet port 1 x RJ-11/Terminal Block connector for VDSL2 line port 1 x removable 6-contact terminal blocks for power1 and alarm contact 1 x removable 2-contact terminal blocks for power2 MTU: 1680 bytes (Jumbo frame)
<b>Flow control:</b>	Full duplex: IEEE 802.3x Half duplex: Back pressure
<b>LED Indicators:</b>	1 x Power LED 4 x Link/Active Status for Ethernet port 1 x Link LED for VDSL2 port
<b>Switch method:</b>	Store and forward
<b>Maximum Power Consumption:</b>	9.6 W
<b>Power Supply:</b>	Redundant dual DC input power 12~48V (Removable Terminal Block)
<b>EMC:</b>	EMI Compliant: FCC Class A EMS Compliant: CE mark Class A
<b>Operating Temperature:</b>	-20°C ~ 70°C (-4°F ~ 158°F) Fanless, free air cooling



<b>Storage Temperature:</b>	-40°C ~70°C (-40°F ~ 158°F)
<b>Humidity:</b>	5 to 95% (non-condensing)
<b>Weight:</b>	0.79 kg
<b>Dimensions:</b>	182mm x 142mm x 35.5mm (7.16" x 5.59 " x 1.39 ")
<b>Chipsets:</b>	Lantiq VRX

## **Appendix C: Router/Bridged Mode select**

This appendix describes how to select the router mode, The NV-600AI default mode is switch(bridged mode), please refer to the following steps to select the router mode or switch mode.

### ◆ **Select the Router mode:**

1. To configure the router mode settings, click the **LAN Settings** link (**LAN > LAN Settings**) on the left navigation bar. Then select the "Server" at the DHCP Mode, and click Apply at any time during configuration to save the information that you have entered. A screen is displayed as shown in [Figure C.1](#)



The screenshot shows the DHCP Mode configuration interface. The 'DHCP Mode' dropdown menu is highlighted with a red box and set to 'Server'. Below it, the 'DHCP Server' section includes fields for 'IP Pool Starting Address' (192.168.1.2), 'IP Pool Ending Address' (192.168.1.254), 'Lease Time' (Half hour), and 'Local Domain Name' (dslgw.lantiq.com). The 'IP Address Reservation' section is visible below with a 'Click Here' link. At the bottom right, there are 'Help', 'Apply', and 'Cancel' buttons.

**Figure C-1 DHCP Mode – Server**

### **Note:**

Please refer to the section 4.7.2 to configure the DHCP Server settings.



2. Click the **WAN Setting** link (**WAN Setting > WAN**) on the left navigation bar to specify the WAN setting. Please cancel the check of the Auto Detect Enable, and Add to config the wan type.



**Figure C-2 WAN Setting**

3. Please refer to the **section 4.5.6** to config the wan type, the user can configure the Dynamic IP Address, Static IP Address, PPPoE mode.

**WAN**

The CPE device can be connected to your service provider in any of the following ways

Attached Channel: 1. ptm0.201

WAN TYPE: Static IP Address

Address Version:  IPv6

IP address assigned by your ISP: [ ] . [ ] . [ ] . [ ]

Subnet Mask: [ ] . [ ] . [ ] . [ ]

ISP Gateway Address: [ ] . [ ] . [ ] . [ ]

Dynamic IP Address  
Static IP Address  
PPPoE  
PPPoA  
Bridge

**Figure C-3 Config WAN Type**

- ◆ Click Apply for applying the changes.
- ◆ Click CANCEL to exit from this page without saving the changes.

■ **Select the Bridged mode:**

1. To configure the bridged mode settings, click the **LAN Settings** link (**LAN > LAN Settings**) on the left navigation bar. Then select the "Disable" at the DHCP Mode, and click Apply at any time during configuration to save the information that you have entered. A screen is displayed as shown in [Figure C.4](#)

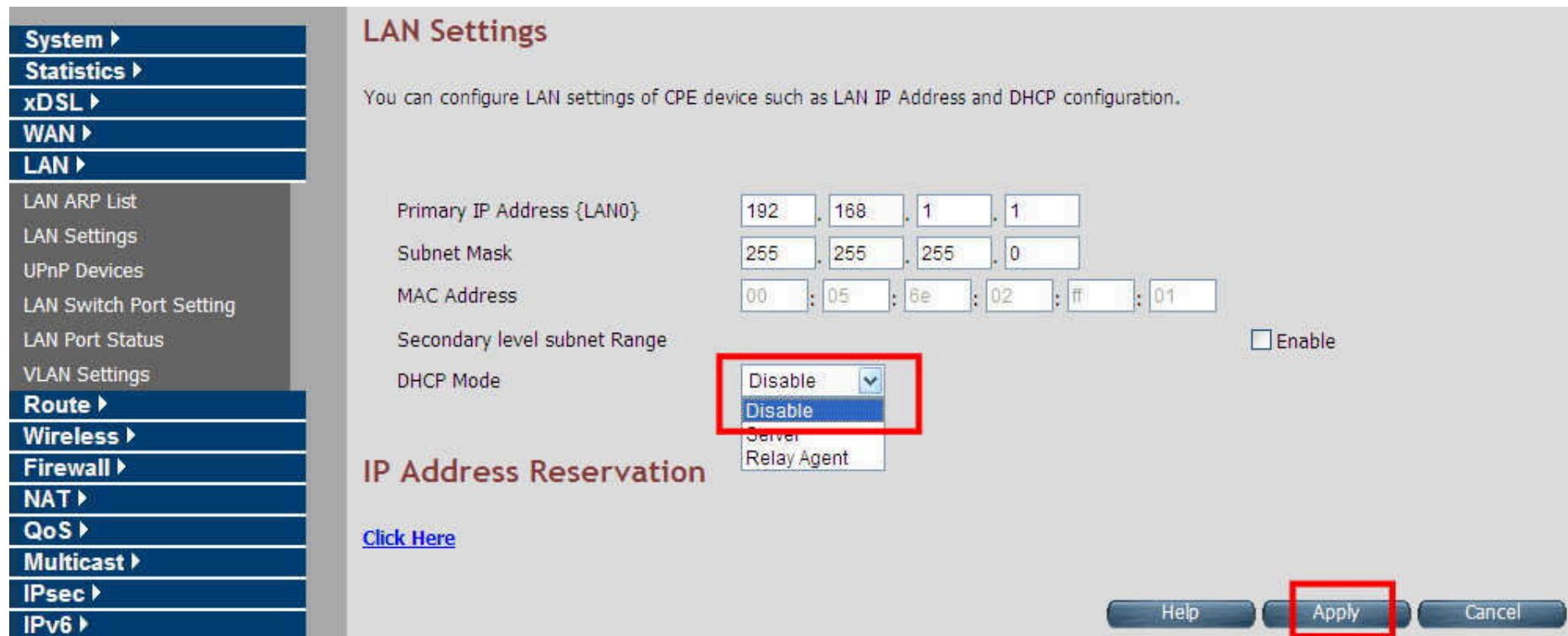

**Figure C-4 DHCP Mode – Disable**

2. Click the **WAN Setting** link (**WAN Setting > WAN**) on the left navigation bar to specify the WAN setting. Please modify WAN settings to Bridge. A screen is displayed as shown in [Figure C.5](#)

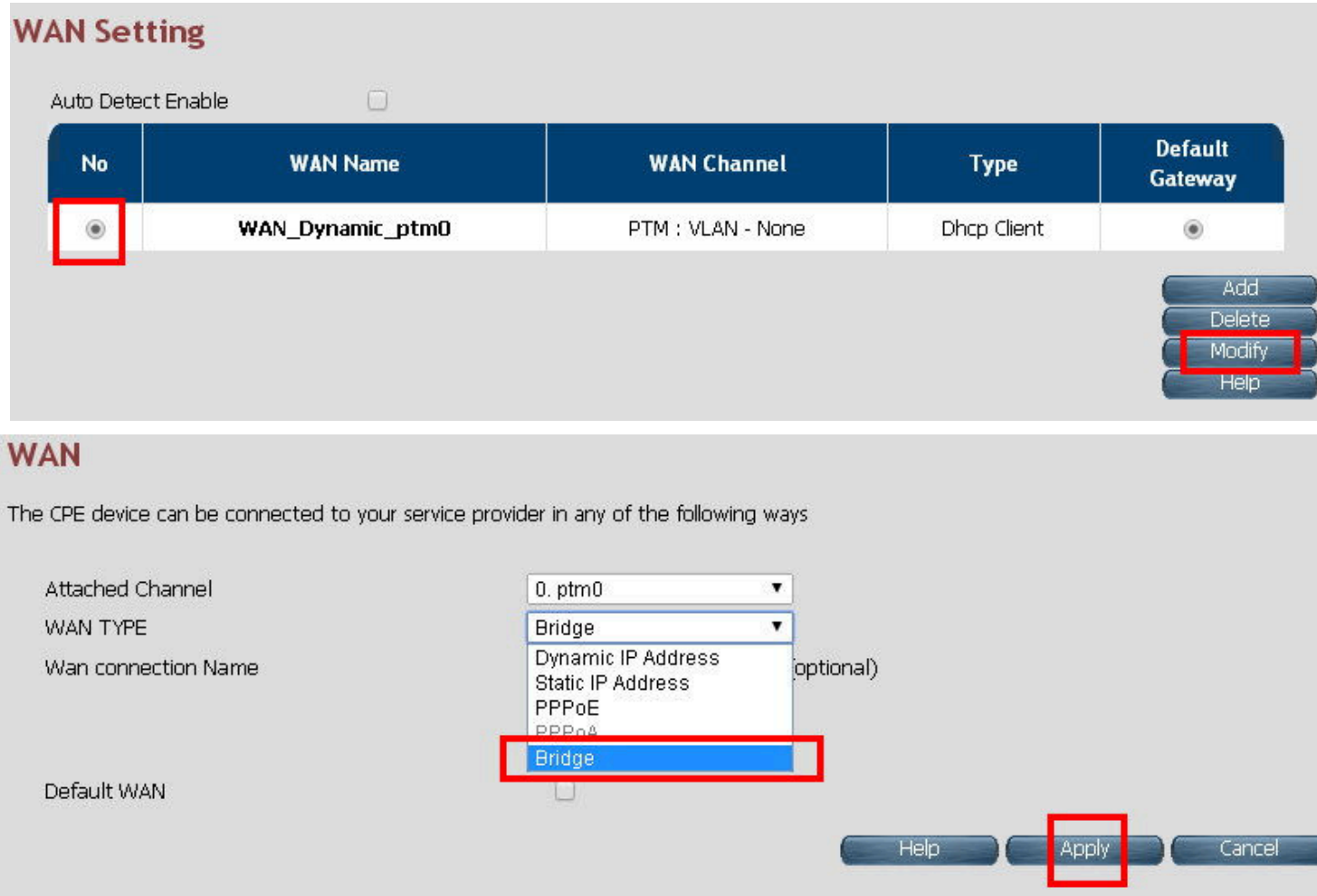

**Figure C-5 WAN Setting**

## Appendix D: NV-600LI/NV-600AI Compatibility Table

### ◆ Compatibility Table(NV-600LI / NV-600AI):

The following shows the band profile and band plan compatibility table:

Band Profile List		Band Plan List	
<b>0</b>	VDSL2 Profile8a	<b>0</b>	Annex A M1_EU32
<b>1</b>	VDSL2 Profile8b	<b>1</b>	Annex A M9_EU64
<b>2</b>	VDSL2 Profile8c	<b>8</b>	Annex B 997-M2x-A (B05)
<b>3</b>	VDSL2 Profile8d	<b>9</b>	Annex B 997-M2x-M (B06)
<b>4</b>	VDSL2 Profile12a	<b>10</b>	Annex B 997-M1c-A-7 (B07)
<b>5</b>	VDSL2 Profile12b	<b>11</b>	Annex B 998-M1x-B (B08)
<b>6</b>	VDSL2 Profile17a	<b>13</b>	Annex B 998-M2x-A (B10)
<b>7</b>	VDSL2 Profile30a	<b>14</b>	Annex B 998-M2x-M (B11)
<b>8</b>	VDSL2 Profile17b	<b>16</b>	Annex B 998-M2x-B (B12)
		<b>18</b>	Annex B 998-M2x-NUS0 (B13)
		<b>20</b>	Annex C
		<b>21</b>	Annex C_8K
		<b>22</b>	Annex B 997-M2x-NUS0
		<b>23</b>	Annex C 1M1
		<b>24</b>	Annex C_8K 1M1
		<b>25</b>	Annex B 998E17-M2x-A
		<b>26</b>	Annex B 998E17-M2x-NUS0

Band Profile \ Band Plan	0	1	8	9	10	11	13	14	16	18	20	21	22	23	24	25	26
0 (8a)	X	X	X	O	X	X	X	X	X	X	X	X	X	X	X	X	X
1 (8b)	X	X	O	O	X	X	X	X	X	X	X	X	X	X	X	X	X
2 (8c)	X	X	X	X	X	X	X	O	X	X	X	X	X	X	X	X	X
3 (8d)	X	X	O	X	X	X	X	X	X	X	X	X	X	X	X	X	X
4 (12a)	X	O	X	X	X	O	X	O	O	X	X	X	X	X	X	X	X
5 (12b)	O	O	X	X	O	O	O	O	O	O	X	X	X	X	X	X	X
6 (17a)	O	X	X	X	O	O	O	O	O	X	O	X	X	O	X	X	X
7 (30a)	O	X	X	X	X	X	X	X	X	X	X	X	X	X	X	X	X
8 (17b)	X	X	X	X	X	X	X	X	X	X	X	X	X	X	X	X	X

## Appendix E: IP-30 protection of metal case

The term “protection class” generally indicates the type of protection of a device or the internal workings of a device against direct contact and against the infiltration of foreign bodies, such as objects, dust or water.

The resistance to stress arising from prevailing working conditions is defined using international protection (IP) classes. These protection classes are, in turn, indicated in IP standards (DIN EN 60529), whereby a combination of two digits specifies the level of protection. The first digit indicates the level of resistance to foreign bodies and dust, the second digit the level of resistance to water infiltration. A higher value of the relevant digit (first digit 0 – 6, second digit 0 - 8) indicates a higher level of protection.

The table on the following offers clarity and an overview of the IP rules:

**Table D-1 First Digit:** Protection grades for contact and foreign matter protection.

Digit	Designation	Explanation
0	No protection	No special protection to prevent infiltration by solid objects.
1	Protection against large foreign matter	Protection against solid objects greater than 50 millimeters in diameter.
2	Protection against mediumsized Foreign matter	Protection against solid objects greater than 12.5 millimeters in diameter.
3	Protection against small foreign matter	Protection against solid objects greater than 2.5 millimeters in diameter.
4	Protection against circular foreign matter	Protection against solid objects greater than 1 millimeter in diameter.
5	Dust protected	Complete protection against dust is not necessary, but infiltration must be prevented to a sufficiently high degree to ensure that the functioning and safety of the device are not impaired.
6	Dustproof	Complete protection against dust infiltration

**Table D-2 Second Digit:** Protection grades for water protection.

Digit	Designation	Explanation
<b>0</b>	No protection	No special protection to prevent water infiltration.
<b>1</b>	Protection against vertically dripping water	Water dripping vertically on to the device may not have any harmful effect.
<b>2</b>	Protection against water dripping at an angle	Water dripping vertically onto a device tilted to an angle of up to 15° from the vertical may not have any harmful effect.
<b>3</b>	Protection against spray water	Protection against water sprayed at any angle up to 60° from the vertical on to the device.
<b>4</b>	Protection against splash water	Water splashing against the device from any direction may not have any harmful effect.
<b>5</b>	Protection against water jets	A jet of water aimed at the housing from any direction may not have any harmful effect.
<b>6</b>	Protection against strong water jets	A strong water jet aimed at the device from any direction may not have any harmful effect.
<b>7</b>	Protection against temporary immersion	When the device is immersed in water up to 1 meter from the lower edge of the device, water may not enter the device in any sufficient quantity to cause damage.
<b>8</b>	Protection against continuous immersion	The device is suitable for continuous immersion in water. The conditions must be individually agreed between the manufacturer and the user but must, at least, exceed the specification of digit 7.



## Appendix F: Troubleshooting

### Diagnosing the Router's Indicators

The router can be easily monitored through its comprehensive panel indicators. These indicators assist the network manager in identifying problems the hub may encounter. This section describes common problems you may encounter and possible solutions.

<b>1. Symptom:</b>	POWER indicator does not light up (green) after power on.
<b>Cause:</b>	Defective External power supply
<b>Solution:</b>	Check the power plug by plugging in another that is functioning properly. Check the power cord with another device. Check the terminal block make sure to fasten the power cord. If these measures fail to resolve the problem, have the unit power supply replaced by a qualified distributor.
<b>Note:</b>	Please refer to power status table to check power input status. Section 3.4
<b>2. Symptom:</b>	Link indicator does not light up (green) after making a connection.
<b>Cause:</b>	Network interface (ex. a network adapter card on the attached device), network cable, or switch port is defective.
<b>Solution:</b>	<ol style="list-style-type: none"> <li>2.1 Power off and re-power on the VDSL2 router.</li> <li>2.2 Verify that the switch and attached device are power on.</li> <li>2.3 Be sure the cable is plugged into both the switch and corresponding device.</li> <li>2.4 Verify that the proper cable type is used and its length does not exceed specified limits.</li> <li>2.5 Check the router on the attached device and cable connections for possible defects.</li> <li>2.6 Make sure that the phone wire must be connecting NV-600AI first, when powered on.</li> <li>2.7 Replace the defective router or cable if necessary.</li> </ol>

<b>3. Symptom:</b>	VDSL Link cannot be established.
<b>Cause:</b>	VDSL setting failure or phone cable length is over the specification limit.
<b>Solution:</b>	<p>3.1 Please make sure that the phone wire must be connected between NV-600LI(CO) and NV-600AI (CPE) when both are power on. NV-600LI (CO) will do link speed function depending on phone wire length, therefore if NV-600LI (CO) can't detect NV-600AI (CPE) over phone wire while both power on, this will cause the link to fail.</p> <p>3.2 Please check phone wire, we recommend use 24-26 gauge with twisted pair and without rust.</p> <p>3.3 Please reinsert power when change cable length or link time over 3 minutes.</p>
<b>Note:</b>	Phone wire must meet CAT 3 standard or above and <b>without clustering</b> , otherwise will cause more cross talk issue to reduce DSL power driver.

<b>4. Question:</b>	What is VDSL2? (Only reference)
<b>Answer:</b>	<p>Very-high-speed digital subscriber line 2 (VDSL2) is an access technology that exploits the existing infrastructure of copper wires that were originally deployed for traditional telephone service. It can be deployed from central offices, from fiber-optic connected cabinets located near the customer premises, or within buildings. It was defined in standard ITU-T G.993.2 finalized in 2005.</p> <p>VDSL2 was the newest and most advanced standard of digital subscriber line (DSL) broadband wireline communications. Designed to support the wide deployment of triple play services such as voice, video, data, high definition television (HDTV) and interactive gaming, VDSL2 was intended to enable operators and carriers to gradually, flexibly, and cost-efficiently upgrade existing xDSL infrastructure.</p>

	<p>The protocol was standardized in the International Telecommunication Union telecommunications sector (ITU-T) as Recommendation G.993.2. It was announced as finalized on 27 May 2005,[1] and first published on 17 February 2006. Several corrections and amendments were published in 2007 through 2011.</p> <p>VDSL2 is an enhancement to very-high-bitrate digital subscriber line (VDSL), Recommendation G.993.1. It permits the transmission of asymmetric and symmetric aggregate data rates up to 200 Mbit/s downstream and upstream on twisted pairs using a bandwidth up to 30 MHz.</p> <p>VDSL2 deteriorates quickly from a theoretical maximum of 250 Mbit/s at source to 100 Mbit/s at 0.5 km (1,600 ft) and 50 Mbit/s at 1 km (3,300 ft), but degrades at a much slower rate from there, and still outperforms VDSL. Starting from 1.6 km (1 mi) its performance is equal to ADSL2+.</p> <p>ADSL-like long reach performance is one of the key advantages of VDSL2. LR-VDSL2 enabled systems are capable of supporting speeds of around 1–4 Mbit/s (downstream) over distances of 4–5 km (2.5–3 miles), gradually increasing the bit rate up to symmetric 100 Mbit/s as loop-length shortens. This means that VDSL2-based systems, unlike VDSL1 systems, are not limited to short local loops or MTU/MDUs only, but can also be used for medium range applications.</p>
--	---

<b>5. Question:</b>	What is SNR(Signal-to-Noise)? (Only reference)
<b>Answer:</b>	Signal-to-noise ratio (often abbreviated SNR or S/N) is a measure used in science and engineering that compares the level of a desired signal to the level of background noise. It is defined as the ratio of signal power to the noise power. A ratio higher than 1:1 indicates more signal than noise. While SNR is commonly quoted for electrical signals, it can be applied to any form of signal (such as

isotope levels in an ice core or biochemical signaling between cells). The ratio is usually measured in decibels(dB)

The signal-to-noise ratio, the bandwidth, and the channel capacity of a communication channel are connected by the Shannon–Hartley theorem.

In digital communications, the SNR will probably cause a reduction in data speed because of frequent errors that require the source (transmitting) computer or terminal to resend some packets of data. SNR measures the quality of a transmission channel over a network channel. The greater the ratio, the easier it is to identify and subsequently isolate and eliminate the source of noise.

<b>6. Symptom:</b>	Connected the CO Router with CPE Router within 300 meters RJ-11 phone cable got only less than 10 Mbit/s.
<b>Cause:</b>	Some testing program which is base on TCP/IP protocol such as FTP, Iperf, NetIQ, the bandwidth of testing outcome will be limited by TCP window size.
<b>Solution:</b>	We recommend to test VDSL2 bandwidth best by Smartbit equipment, if you don't have Smartbit, we recommend test that by IPERF program, and TCP window size must be setting max. to 64k, the parameter as iperf -c server IP address -i 1 -t 50 -w 65535 for client side.

<b>7. Question:</b>	I just bought a Netsys NV-600AI to replace my Quest DSL modem for my home. I was told any VDSL2 modem would replace and give me higher communication speeds. It doesn't get me internet when hooked up. All lights come on but no Link light. Is this the complete wrong application for this unit?
<b>Answer:</b>	Re: Please note that the NV-600AI is a remote side(CPE side), it must be connected to the CO side before you can work. Furthermore, Tone mode, Band profile and band plan configuration must compatible to each other, if the link does not establish that the link led will off. Finally, please deactivate and activate once when the VDSL2 configuration has been changed.

<b>8. Question:</b>	We need to set up a default gateway on a NV-600 pair which are in Bridge mode, as they want to manage the units from a different network.
<b>Answer:</b>	<p>When the application is used within the LAN, the switch(bridged) mode is not necessary to set up a gateway .However, if the application crosses various network segments (LAN to WAN or WAN to LAN), you must set up a gateway to connect different network segment.</p> <p>Regarding how to configure a default gateway at switch(bridged) mode for crossing various network segments , please refer to the section 4.8.1 for your reference.</p> <p>Configuration gateway example from static routing:  Destination LAN IP: 0-0-0-0  Subnet Mask: 0-0-0-0  Gateway: 255-255-255-0</p> <p><b>Note:</b> Static Routing functionality is used to define the connected Gateway between the LAN and WAN.</p>
<b>9. Question:</b>	Is it possible to use ADSL2 IP DSLAM with the NV-600AI?
<b>Answer:</b>	NV-600AI support the ADSL Annex B backward compatible, therefore the NV-600AI can connect to ADSL2 IP DSLAM.
<b>10. Question:</b>	What can I do if I forgot my password?
<b>Answer:</b>	If you forgot your password, you must reset your router. This process will change all your settings back to the factory default. To reset the router, locate the reset button on the rear panel of the unit. With the router powered on, use a paperclip to hold the button down for over 5 seconds. Release the

	button and the router will go through its reboot process. The default IP is 192.168.16.254 When logging in, the default username and password are both <b>“admin”</b> .
--	---

<b>11. Question:</b>	What is the maximum Ethernet frame MTU for these routers?
----------------------	---

<b>Answer:</b>	NV-600AI maximum Ethernet frame MTU is 1680 bytes.
----------------	--

## System Diagnostics

### Power and Cooling Problems

If the POWER indicator does not turn on when the power cord is plugged in, you may have a problem with the power outlet, power cord, or internal power supply as explained in the previous section. However, if the unit power is off after running for a while, check for loose power connections, power losses or surges at the power outlet. If you still cannot isolate the problem, then the internal power supply may be defective. In this case, please contact your local dealer.

### Installation

Verify that all system components have been properly installed. If one or more components appear to be malfunctioning (e.g. the power cord or network cabling), test them in an alternate environment where you are sure that all the other components are functioning properly.

### Transmission Mode

The default method of selecting the transmission mode for RJ-45 ports is 10/100 Mbps ETHERNET, for RJ-11 port are auto-negotiation VDSL. Therefore, if the Link signal is disrupted (e.g. by unplugging the network cable and plugging it back in again, or by resetting the power), the port will try to reestablish communications with the attached device via auto-negotiation. If auto-negotiation fails, then communications are set to half duplex by default. Based on this type of commercial-standard connection policy, if you are using a full-duplex device that does not support auto-negotiation, communications can be easily lost (i.e. reset to the wrong mode) whenever the attached device is reset or experiences a power fluctuation. The best way to resolve this problem is to upgrade these devices to a version that support Ethernet and VDSL.

### **Physical Configuration**

If problems occur after altering the network configuration, restore the original connections, and try to track the problem down by implementing the new changes, one step at a time. Ensure that cable distances and other physical aspects of the installation do not exceed recommendations.

### **System Integrity**

As a last resort verify the switch integrity with a power-on reset. Turn the power to the switch off and then on several times. If the problem still persists and you have completed all the preceding diagnoses, then contact your dealer.



## **Appendix G: Compliance Information**

### **FCC Radio Frequency Interference Statement**

This equipment has been tested and found to comply with the limits for a computing device, pursuant to Part 15 of FCC rules. These limits are designed to provide reasonable protection against harmful interference when the equipment is operated in a commercial environment. This equipment generates uses and can radiate radio frequency energy and, if not installed and used in accordance with the instructions, may cause harmful interference to radio communications. However, there is no guarantee that interference will not occur in a particular installation. If this equipment does cause harmful interference to radio or television reception, which can be determined by turning the equipment off and on, the user is encouraged to try to correct the interference by one or more of the following measures:

1. Reorient or relocate the receiving antenna.
2. Increase the separation between the equipment and receiver.
3. The equipment and the receiver should be connected to outlets on separate circuits.
4. Consult the dealer or an experienced radio/television technician for help.

Changes or modifications not expressly approved by the party responsible for compliance could void the user's authority to operate the equipment.

If this telephone equipment causes harm to the telephone network, the telephone company will notify you in advance that temporary discontinuance of service may be required. But if advance notice isn't practical, the telephone company will notify the customer as soon as possible. Also, you will be advised of your right to file a complaint with the FCC if you believe it is necessary.

The telephone company may make changes in its facilities, equipment, operations or procedures that could affect the proper functioning of your equipment. If they do, you will be notified in advance in order for you to make necessary modifications to maintain uninterrupted service.

This equipment may not be used on coin service provided by the telephone company. Connection to party lines is subject to state tariffs.

**FCC Warning**



This equipment has been tested to comply with FCC, pursuant to Part 15 of the FCC Rules. These limits are designed to provide reasonable protection against harmful interference when the equipment is operated in a commercial environment. This equipment can generate, use, and radiate radio frequency energy and, if not installed and used in accordance with the instruction manual, may cause harmful interference to radio communications. Operation of this equipment in a residential area is likely to cause harmful interference in which case the user will be required to correct the interference at owner's expense.

**CE Mark Warning**



In a domestic environment, this product may cause radio interference in which case the user may be required to take adequate measures.

### RoHS Mark Warning



RoHS stands for Restriction of Hazardous Substances, and impacts the entire electronics industry and many electrical products as well. The original RoHS, also known as Directive 2002/95/EC, originated in the European Union in 2002 and restricts the use of six hazardous materials found in electrical and electronic products. All applicable products in the EU market since July 1, 2006 must pass RoHS compliance. Directive 2011/65/EU was published in 2011 by the EU, which is known as RoHS-Recast or RoHS 2. RoHS 2 includes a **CE-marking directive**, with RoHS compliance now being required for CE marking of products. RoHS 2 also added Categories 8 and 9, and has additional compliance recordkeeping requirements. Directive 2015/863 was published in 2015 by the EU, which is known as RoHS 3. RoHS 3 adds four additional restricted substances (phthalates) to the list of six.

### WEEE Warning



To avoid the potential effects on the environment and human health as a result of the presence of hazardous substances in electrical and electronic equipment, end users of electrical and electronic equipment should understand the meaning of the crossed-out wheeled bin symbol. Do not dispose of WEEE as unsorted municipal waste and have to collect such WEEE separately.

## Warranty

The original product that the owner delivered in this package will be free from defects in material and workmanship for one year parts after purchase.

There will be a minimal charge to replace consumable components, such as fuses, power transformers, and mechanical cooling devices. The warranty will not apply to any products which have been subjected to any misuse, neglect or accidental damage, or which contain defects which are in any way attributable to improper installation or to alteration or repairs made or performed by any person not under control of the original owner.

The above warranty is in lieu of any other warranty, whether express, implied, or statutory, including but not limited to any warranty of merchantability, fitness for a particular purpose or any warranty arising out of any proposal, specification or sample. We shall not be liable for incidental or consequential damages. We neither assume nor authorize any person to assume for it any other liability.

**WARNING**  
Warranty Void  
If Removed

### **WARNING:**

- 1. DO NOT TEAR OFF OR REMOVE THE WARRANTY STICKER AS SHOWN, OR THE WARRANTY IS VOID.**
- 2. WARRANTY VOID IF USE COMMERCIAL-GRADE POWER ADAPTER IS USED AT HARSH ENVIRONMENTS.**

**Chinese SJ/T 11364-2014**

部件名称	有毒有害物质或元素					
	铅(Pb)	汞(Hg)	镉(Cd)	六价铬[Cr(VI)]	多溴联苯(PBB)	多溴二苯醚(PBDE)
结构壳体	○	○	○	○	○	○
电路组	○	○	○	○	○	○
包装及配件	○	○	○	○	○	○
○：表示该有毒物质在该部件所有均质材料中的含量均在 GB/T 26572 标准规定的限量要求以下。 ×：表示该有毒物质至少在该部件的某依均质材料中的含量超出 GB/T 26572 标准规定的限量要求。						

上述规范仅适用于中国法律