



KGS-810F Ver.B

**Web Smart 8-Port Gigabit Ethernet Switch
with 1 mini-GBIC Port**

KGS-810F-B
Software rev1.081 or later

User's Manual



DOC.150331

(C) 2012-2015 KTI Networks Inc. All rights reserved. No part of this documentation may be reproduced in any form or by any means or used to make any derivative work (such as translation or transformation) without permission from KTI Networks Inc.

KTI Networks Inc. reserves the right to revise this documentation and to make changes in content from time to time without obligation on the part of KTI Networks Inc. to provide notification of such revision or change.

For more information, contact:

United States KTI Networks Inc.
P.O. BOX 631008
Houston, Texas 77263-1008

Phone: 713-2663891
Fax: 713-2663893
E-mail: kti@ktinet.com
URL: <http://www.ktinet.com/>

International Fax: 886-2-26983873
E-mail: kti@ktinet.com.tw
URL: <http://www.ktinet.com.tw/>

The information contained in this document is subject to change without prior notice. Copyright (C) All Rights Reserved.

TRADEMARKS

Ethernet is a registered trademark of Xerox Corp.

FCC NOTICE

This device complies with Class A Part 15 the FCC Rules. Operation is subject to the following two conditions:

(1) This device may not cause harmful interference, and (2) this device must accept any interference received including the interference that may cause.

CE NOTICE

Marking by the symbol indicates compliance of this equipment to the EMC directive of the European Community. Such marking is indicative that this equipment meets or exceeds the following technical standards:

EMC Class A

EN55022 Class A

EN61000-3-2

EN61000-3-3

EN 55024

IEC 61000-4-2

IEC 61000-4-3

IEC 61000-4-4

IEC 61000-4-5

IEC 61000-4-6

IEC 61000-4-8

IEC 61000-4-11

VCCI NOTICE

この装置は、クラスA情報技術装置です。この装置を家庭環境で使用すると電波妨害を引き起こすことがあります。この場合には使用者が適切な対策を講ずるよう要求されることがあります。

VCCI-A

Table of Contents

1. Introduction.....	7
1.1 Features.....	8
1.2 Product Panels.....	9
1.3 LED Indicators	9
1.4 Specifications.....	9
2. Installation.....	12
2.1 Unpacking.....	12
2.2 Safety Cautions.....	12
2.3 Mounting the Switch on a Wall.....	13
2.4 Mounting the Switch on a Din-rail Chassis.....	13
2.5 Applying Power	14
2.6 Reset Button	15
2.7 Making UTP Connections	15
2.8 Making Fiber Connection	16
2.9 LED Indication.....	17
2.10 Configuring IP Address and Password for the Switch.....	17
3. Advanced Functions	18
3.1 Abbreviation	18
3.2 QoS Function	20
3.2.1 Packet Priority Classification.....	21
3.2.2 Priority Class Queues	21
3.2.3 Egress Service Policy	21
3.3 VLAN Function.....	22
3.3.1 VLAN Operation.....	22
3.3.2 Ingress Rules	22
3.3.2.1 802.1Q Tag Aware Per port setting.....	22
3.3.2.2 Keep Tag Per port setting	23
3.3.2.3 Drop Untagged Per Port Setting	23
3.3.2.4 Drop Tagged Per Port Setting.....	23

3.3.3 Ingress Default Tag Per Port Setting	23
3.3.4 Packet Tag Information	23
3.3.5 VLAN Group Table Configuration	24
3.3.6 VLAN Classification	24
3.3.7 Packet Forwarding	24
3.3.8 Egress Tagging Rules.....	25
3.3.8.1 Egress Settings.....	25
3.3.9 Summary of VLAN Function.....	25
3.4 802.1X Authentication.....	26
4. Web Management.....	28
4.1 Start Browser Software and Making Connection	28
4.2 Login to the Switch Unit	28
4.3 Main Management Menu	29
4.4 System	31
4.4.1 Management VLAN.....	33
4.5 Ports.....	34
4.5.1 SFP DDM Status.....	35
4.6 VLANs.....	36
4.6.1 Port-based VLAN Mode	37
4.6.2 Port-based VLAN ISP Mode	38
4.6.3 Advanced VLAN Mode.....	39
4.6.3.1 Ingress Default Tag.....	40
4.6.3.2 Ingress Settings	41
4.6.3.3 Egress Settings.....	43
4.6.3.4 VLAN Groups.....	45
4.6.4 Important Notes for VLAN Configuration.....	46
4.7 LACP	47
4.8 RSTP	48
4.9 802.1X Configuration	50
4.9.1 802.1X Re-authentication Parameters	51
4.10 IGMP Snooping.....	52
4.11 Mirroring	53

4.12 Quality of Service	54
4.12.1 802.1p Mapping	55
4.12.2 DSCP Mapping	56
4.12.3 QoS Service Policy	57
4.13 Storm Control	59
4.14 Statistics Overview	60
4.15 Detailed Statistics	61
4.16 LACP Status	62
4.17 RSTP Status	64
4.18 IGMP Status	66
4.19 Ping	67
4.20 Warm Restart	67
4.21 Factory Default	68
4.22 Software Update	68
4.23 Configuration File Transfer	69
4.24 Logout	69
5. SNMP Support	70
Appendix. Factory Default Settings	71

1. Introduction

The KGS-810F-B is a managed Gigabit Ethernet switch which is featured with the following switched ports:

- Seven 10/100/1000Mbps Gigabit copper ports
- One combo port - 10/100/1000Mbps copper & 1000Base-X SFP

and the following advantages in a small footprint box:



Plug and Play

The switch is shipped with factory default configuration which behaves like an unmanaged Gigabit switch for workgroup. It provides eight 10/100/1000Mbps copper ports for connections to Ethernet, Fast Ethernet, and Gigabit Ethernet devices. With the featured auto-negotiation function, the switch can detect and configure the connection speed and duplex automatically. The switch also provides auto MDI/MDI-X function, which can detect the connected cable and switch the transmission wire pair and receiving pair automatically. This auto-crossover function can simplify the type of network cables used.

Fiber Connectivity

The combo port provides one 1000M SFP slot, which can be installed with an optional SFP optical fiber transceiver to support one Gigabit 1000Base-X fiber connection when needed.

Web Management

The switch is embedded with an Http server which provides management functions for advanced network functions including Port Control, Quality of Service, and Virtual LAN functions. The management can be performed via Web browser based interface over TCP/IP network.

Quality of Service

For advanced application, the switch is featured with powerful Quality of Service (QoS) function which can classify the priority for received network frames based on the ingress port and frame contents. Furthermore, many service priority policies can be configured for egress operation in per-port basis.

Virtual LAN (VLAN)

For increasing Tagged VLAN applications, the switch is also featured with powerful VLAN function to fulfill

the up-to-date VLAN requirements. The switch supports both port-based VLAN and tagged VLAN in per-port basis.

802.1x Authentication

IEEE 802.1X port-based network access control function provide a means of authenticating and authorizing devices attached to the switched port that has point-to-point connection characteristics, and of preventing access to that port in cases in which the authentication and authorization process fails.

1.1 Features

- Provides 8 10/100/1000Mbps RJ-45 and one 1000M SFP slot
- Provides in-band web-based and SNMP management interface
- Copper ports support auto-negotiation and auto-MDI/MDI-X detection.
- Provides full wire speed forwarding
- Supports 802.3x flow control for full-duplex and backpressure for half-duplex
- Provides port status, statistic monitoring and control function
- Supports DHCP IP configuration
- Supports port-based and 802.1Q Tag-based VLAN
- Provides QoS function
- Provides link aggregation (port trunking) function with LACP support
- Provides port mirroring function
- Provides 802.1X authentication for port access
- Supports 802.1w RSTP, 802.1D STP
- Provides IGMP snooping
- Supports SFP with Digital Diagnostic Monitoring (DDM)
- Provides packet storm control function
- In-band embedded firmware upgrade function
- Power saving function

1.2 Product Panels

The following figure illustrates the front panel and rear panel of the switch:

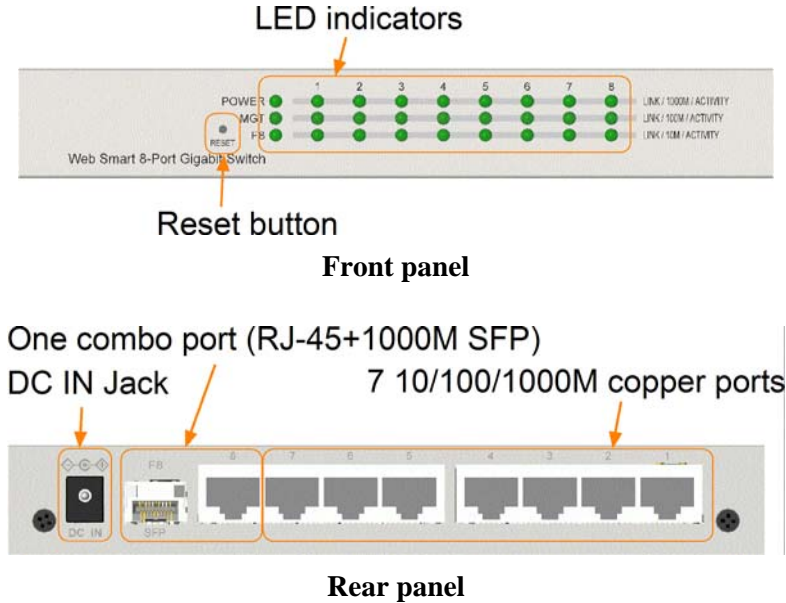

1.3 LED Indicators

LED	Function
POWER	Power status
MGT	Management status
LNK/1000M/ACT	Network port 1000M link status (Port 1 - Port 8)
LNK/100M/ACT	Network port 100M link status (Port 1 - Port 8)
LNK/10M/ACT	Network port 10M link status (Port 1 - Port 8)
FX8	SFP Fiber is selected on Port 8

1.4 Specifications

10/100/1000 Copper Ports

Compliance	IEEE 802.3 10Base-T, IEEE 802.3u 100Base-TX, IEEE 802.3u 1000Base-T
Connectors	Shielded RJ-45 jacks
Pin assignments	Auto MDI/MDI-X detection
Configuration	Auto-negotiation or software control
Transmission rate	10Mbps, 100Mbps, 1000Mbps
Duplex support	Full/Half duplex
Network cable	Cat.5 UTP

Combo Port with 10/100/1000 RJ-45 and 1000Mbps Mini-GBIC SFP

Copper interface

Compliance	IEEE 802.3 10Base-T, IEEE 802.3u 100Base-TX,
------------	----------------------------------------------

	IEEE 802.3u 1000Base-T
Connectors	Shielded RJ-45 jacks
Pin assignments	Auto MDI/MDI-X detection
Configuration	Auto-negotiation or software control
Transmission rate	10Mbps, 100Mbps, 1000Mbps
Duplex support	Full/Half duplex
Network cable	Cat.5 UTP

Fiber interface

Compliance	IEEE 802.3z 1000Base-SX/LX (mini-GBIC)
Connectors	SFP for optional SFP type fiber transceivers
Configuration	Auto/Forced, 1000Mbps, Full duplex
Transmission rate	1000Mbps
Network cables	MMF 50/125 60/125, SMF 9/125
Eye safety	IEC 825 compliant

Switch Functions

MAC Addresses Table	8K entries
Forwarding & filtering	Non-blocking, full wire speed
Switching technology	Store and forward
Maximum packet length	1526 bytes (when Jumbo frame support disabled)
Jumbo frame support	9.6K bytes
IP Multicast groups	8192 supported
Flow control	IEEE 802.3x pause frame base for full duplex operation Back pressure for half duplex operation
VLAN function	Port-based VLAN and IEEE 802.1Q Tag-based VLAN 4095 VLANs supported, IVL support
QoS function	Port-based, 802.1p-based, IP DSCP-based
Port control	Port configuration control via software management
Storm control	Broadcast, Multicast storm protection control via software management
Aggregation	LACP Link aggregation (port trunking)
Port Mirroring	Mirror received frames to a sniffer port

Software Management Functions

Interfaces	Web browser
Management objects	System configuration - IP settings, Name, Password Port configuration control and status VLAN function settings

Port Link Aggregation function settings
Link Aggregation LACP settings
RSTP settings
802.1X port access control
IGMP snooping
Port mirroring settings
QoS function settings
Storm protection control settings
Port statistic, LACP status, RSTP status
Reboot, restore factory default, update firmware

DC Power Input

Interfaces DC Jack (-D 6.3mm / + D 2.0mm)
Operating Input Voltages +5 ~ +12.6VDC
Power Consumption 7.3W max. @7.5V

Mechanical

Dimension (base) 180 x 114 x 26 mm
Housing Enclosed metal with no fan
Mounting Desktop mounting, wall mounting, Din-rail mounting

Environmental

Operating Temperature Typical -5°C ~ 50°C
Storage Temperature -20°C ~ 85°C
Relative Humidity 10% ~ 90%

Electrical Approvals

FCC Part 15 rule Class A
CE EMC, CISPR22 Class A
VCCI Class A

2. Installation

2.1 Unpacking

The product package contains:

- The switch unit
- One power adapter
- One product CD-ROM

2.2 Safety Cautions

To reduce the risk of bodily injury, electrical shock, fire and damage to the product, observe the following precautions.

- Do not service any product except as explained in your system documentation.
- Opening or removing covers may expose you to electrical shock.
- Only a trained service technician should service components inside these compartments.
- If any of the following conditions occur, unplug the product from the electrical outlet and replace the part or contact your trained service provider:
 - The power cable, extension cable, or plug is damaged.
 - An object has fallen into the product.
 - The product has been exposed to water.
 - The product has been dropped or damaged.
 - The product does not operate correctly when you follow the operating instructions.
- Do not push any objects into the openings of your system. Doing so can cause fire or electric shock by shorting out interior components.
- Operate the product only from the type of external power source indicated on the electrical ratings label. If you are not sure of the type of power source required, consult your service provider or local power company.

2.3 Mounting the Switch on a Wall

The switch can be mounted on a desktop or shelf or a wall. Make sure that there is proper heat dissipation from and adequate ventilation around the device. Do not place heavy objects on the device.

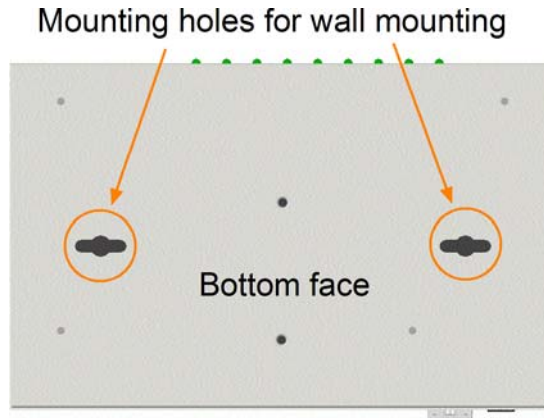

2.4 Mounting the Switch on a Din-rail Chassis

The switch also can be mounted on a din-rail chassis. The steps are:

1. Screw the din-rail mounting bracket on the bottom of the switch.

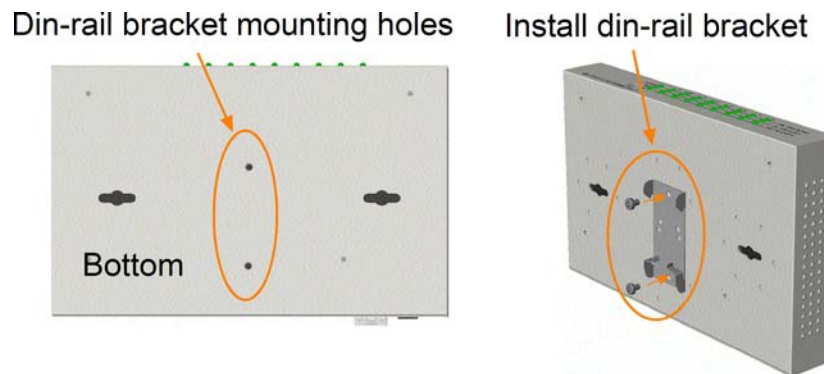

2. Mount the units on a din-rail chassis

The din-rail mounting bracket is optional. Consult the place where you purchased the product.

2.5 Applying Power

Before you begin the installation, check the AC voltage of your area. The AC power adapter which is used to supply the DC power for the unit should have the AC voltage matching the commercial power voltage in your area.

The bundled AC Power Adapter options:



AC input power: AC power voltage of your area Rated AC100 - 240V/47-63Hz

DC output power: Options DC7.5V 1.2A / DC12V 0.8A / DC12V 1A / DC 5V 2A

The steps to apply the power to the product are:

1. Connect power adapter DC plug to the DC input jack located on the back of the unit before connecting to the AC outlet.
2. Connect the power adapter to the AC outlet.
3. Check Power LED indication.

Note: Before you begin the installation, check the AC voltage of your area. The AC power adapter which is used to supply the DC power for the unit should have the AC voltage matching the commercial power voltage in your area.

2.6 Reset Button

The reset button is used to perform a reset to the switch. It is not used in normal cases and can be used for diagnostic purpose. If any network hanging problem is suspected, it is useful to push the button to reset the switch without turning off the power. Check whether the network is recovered. The button can also be used to restore the software configuration settings to factory default values.

The operations are:

Operation	Function
Press the button more than 5 seconds when power up	Restore all factory default settings
Press the button and release during switch operation	Reboot the switch

2.7 Making UTP Connections

The 10/100/1000 RJ-45 copper ports support the following connection types and distances:

Network Cables

10BASE-T: 2-pair UTP Cat. 3, 4, 5, EIA/TIA-568B 100-ohm

100BASE-TX: 2-pair UTP Cat. 5, EIA/TIA-568B 100-ohm

1000BASE-T: 4-pair UTP Cat. 5 or higher (Cat.5e is recommended), EIA/TIA-568B 100-ohm

Link distance: Up to 100 meters

Auto MDI/MDI-X Function

This function allows the port to auto-detect the twisted-pair signals and adapts itself to form a valid MDI to MDI-X connection with the remote connected device automatically. No matter a straight through cable or crossover cable are connected, the ports can sense the receiving pair automatically and configure themselves to match the rule for MDI to MDI-X connection. It simplifies the cable installation.

Auto-negotiation Function

The ports are featured with auto-negotiation function and full capability to support connection to any Ethernet devices. The port performs a negotiation process for the speed and duplex configuration with the connected device automatically when each time a link is being established. If the connected device is also auto-negotiation capable, both devices will come out the best configuration after negotiation process. If the connected device is incapable in auto-negotiation, the switch will sense the speed and use half duplex for the connection.

Port Configuration Management

For making proper connection to an auto-negotiation incapable device, it is suggested to use port control

function via software management to set forced mode and specify speed and duplex mode which match the configuration used by the connected device.

2.8 Making Fiber Connection

The SFP slot must be installed with an SFP fiber transceiver for making fiber connection. Your switch may come with some SFP transceivers pre-installed when it is shipped.

Installing SFP Fiber Transceiver

To install an SFP fiber transceiver into SFP slot, the steps are:

1. Turn off the power to the switch.
2. Insert the SFP fiber transceiver into the SFP slot. Normally, a bail is provided for every SFP transceiver. Hold the bail and make insertion.
3. Until the SFP transceiver is seated securely in the slot, place the bail in lock position.

Connecting Fiber Cables

LC connectors are commonly equipped on most SFP transceiver modules. Identify TX and RX connector before making cable connection. The following figure illustrates a connection example between two fiber ports:

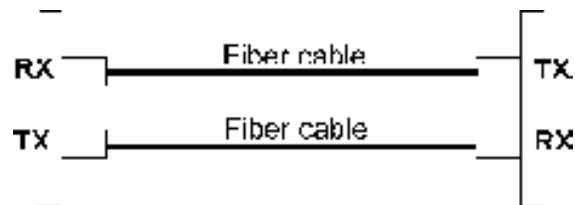

Make sure the Rx-to-Tx connection rule is followed on the both ends of the fiber cable.

Network Cables

Multimode (MMF) - 50/125 μ m, 62.5/125 μ m

Single mode (SMF) - 9/125 μ m

Fiber Port Configuration

For 1000M fiber application on Port 8, just leave the default port configuration *Auto* for fiber connection.

2.9 LED Indication

LED	Function	State	Interpretation
POWER	Power status	ON	The power is supplied to the switch.
		OFF	The power is not supplied to the switch.
MGT	Management status	OFF	The switch is in initialization.
		ON	The switch is initialized completely.
LNK/1000M/ACT	Port link status	ON	A 1000Mbps link is established. (No traffic)
		BLINK	Port link is up and there is traffic.
		OFF	Port link is down.
LNK/100M/ACT	Port link status	ON	A 100Mbps link is established. (No traffic)
		BLINK	Port link is up and there is traffic.
		OFF	Port link is down.
LNK/10M/ACT	Port link status	ON	A 10Mbps link is established. (No traffic)
		BLINK	Port link is up and there is traffic.
		OFF	Port link is down.
FX8	FX8 status	OFF	RJ-45 copper connection is selected on Port 8.
		ON	SFP fiber connection is selected on Port 8.

2.10 Configuring IP Address and Password for the Switch

The switch is shipped with the following factory default settings for software management:

Default IP address of the switch: *192.168.0.2 / 255.255.255.0*

The IP Address is an identification of the switch in a TCP/IP network. Each switch should be designated a new and unique IP address in the network. Refer to Web management interface for System Configuration.

The switch is shipped with factory default password *123* for software management.

The password is used for authentication in accessing to the switch via Http web-based interface. For security reason, it is recommended to change the default settings for the switch before deploying it to your network. Refer to Web management interface for System Configuration.

3. Advanced Functions

To help a better understanding about the software management interfaces, this chapter describes some advanced functions provided by the switch.

3.1 Abbreviation

Ingress Port: Ingress port is the input port on which a packet is received.

Egress Port: Egress port is the output port from which a packet is sent out.

IEEE 802.1Q Packets: A packet which is embedded with a VLAN Tag field

VLAN Tag: In IEEE 802.1Q packet format, 4-byte tag field is inserted in the original Ethernet frame between the Source Address and Type/Length fields. The tag is composed of:

<u>#of bits</u>	<u>16</u>	<u>3</u>	<u>1</u>	<u>12</u>
Frame field	TPID	User priority	CFI	VID

TPID: 16-bit field is set to 0x8100 to identify a frame as an IEEE 802.1Q tagged packet

User Priority: 3-bit field refer to the 802.1p priority

CFI: The Canonical Format Indicator for the MAC address is a 1 bit field.

VID: VLAN identifier, 12-bit field identifies the VLAN to which the frame belongs to.

Untagged packet: A standard Ethernet frame with no VLAN Tag field

Priority-tagged packet: An IEEE 802.1Q packet which VID filed value is zero (VID=0)

VLAN-Tagged packet: An IEEE 802.1Q packet which VID filed value is not zero (VID<>0)

PVID (Port VID): PVID is the default VID of an ingress port. It is often used in VLAN classification for untagged packets. It is also often used for egress tagging operation.

DSCP: Differentiated Service Code Point, 6-bit value field in an IP packet

VLAN Table lookup: The process of searching VLAN table to find a VLAN which matches the given VID index

MAC address table lookup: The process of searching MAC address table to find a MAC entry which matches the given destination MAC address and the port where the MAC address is located

Packet forwarding: also known as packet switching in a network switch based on MAC address table and VLAN table information

VLAN forwarding: the operation that a packet is forwarded to an egress destination port based on VLAN table information

VLAN group: configuration information about a VLAN which can be recognized in the switch. The

information includes a VID associated to the VLAN, member ports, and some special settings.

3.2 QoS Function

The switch provides a powerful Quality of Service (QoS) function to guide the packet forwarding in four priority classes. The versatile classification methods can meet most of the application needs. The following figure illustrates the QoS operation flow when a packet received on the ingress port until it is transmitted out from the egress port:

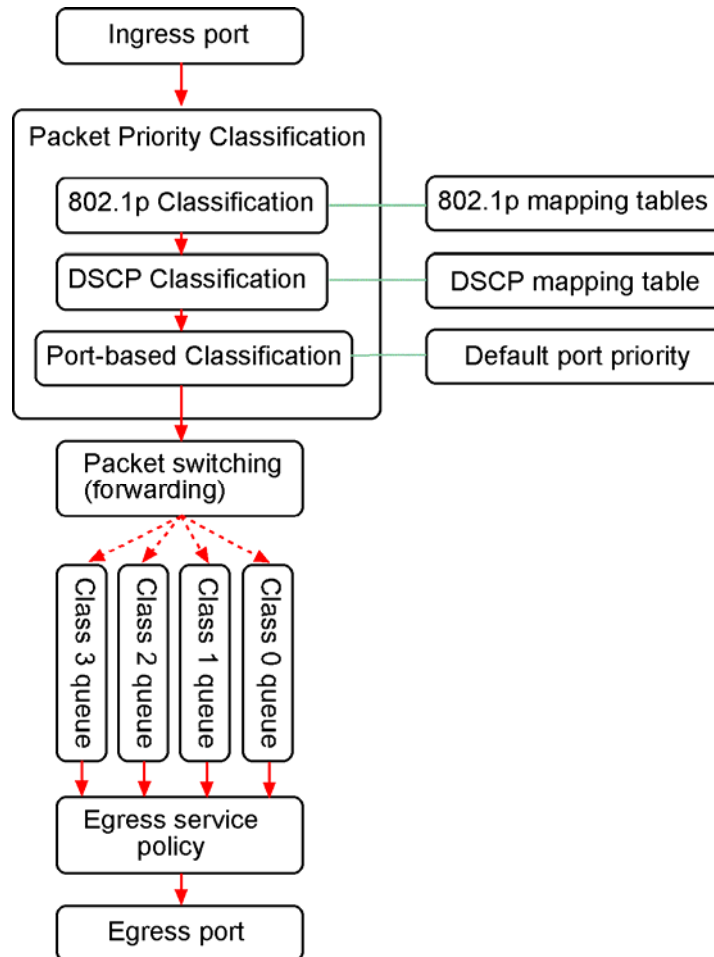

3.2.1 Packet Priority Classification

Each received packet is examined and classified into one of four priority classes, Class 3, Class 2, Class 1 and Class 0 upon reception. The switch provides the following classification methods:

802.1p classification: use User Priority tag value in the received IEEE 802.1Q packet to map to one priority class

DSCP classification: use DSCP value in the received IP packet to map to one priority class

Port-based classification: used when 802.1p and DSCP are disabled or fail to be applied

They all can be configured to be activated or not. More than one classification methods can be enabled at the same time. However, 802.1p classification is superior than DSCP classification.

802.1p mapping tables: Each ingress port has its own mapping table for 802.1p classification.

DSCP mapping table: All ingress ports share one DSCP mapping table for DSCP classification.

Default port priority: A port default priority class is used when port-based classification is applied

All configuration settings are in per port basis except that DSCP mapping table is global to all ports. A received packet is classified into one of four priority class before it is forwarded to an egress port.

3.2.2 Priority Class Queues

Each egress port in the switch is equipped with four priority class egress queues to store the packets for transmission. A packet is stored into the class queue which is associated to the classified priority class. For example, a packet is stored into Class 3 egress queue if it is classified as priority Class 3.

3.2.3 Egress Service Policy

Each port can be configured with an egress service policy to determine the transmission priority among four class queues. By default, higher class number has higher priority than the lower class numbers.

Four policies are provided for selection as follows:

Strict priority: Packets in high priority class queue are sent first until the queue is empty

Weighted ratio priority Class 3:2:1:0 = 4:3:2:1: four queues are served in 4:3:2:1 ratio

Weighted ratio priority Class 3:2:1:0 = 5:3:1:1: four queues are served in 5:3:1:1 ratio

Weighted ratio priority Class 3:2:1:0 = 1:1:1:1: four queues are served equally

Strict priority policy lets high priority class queue is served first until it is empty. Lower priority queue may not

get any service (or egress bandwidth) when higher priority traffic is heavy for long time. Three weighted ratio policies are provided to resolve such problem. Four class queues are served in weighted round robin basis. Every priority class can get a guaranteed ratio for the egress bandwidth.

3.3 VLAN Function

The switch supports port-based VLAN, 802.1Q Tag VLAN and eight VLAN groups.

3.3.1 VLAN Operation

The following figure illustrates the basic VLAN operation flow beginning from a packet received on an ingress port until it is transmitted from an egress port.

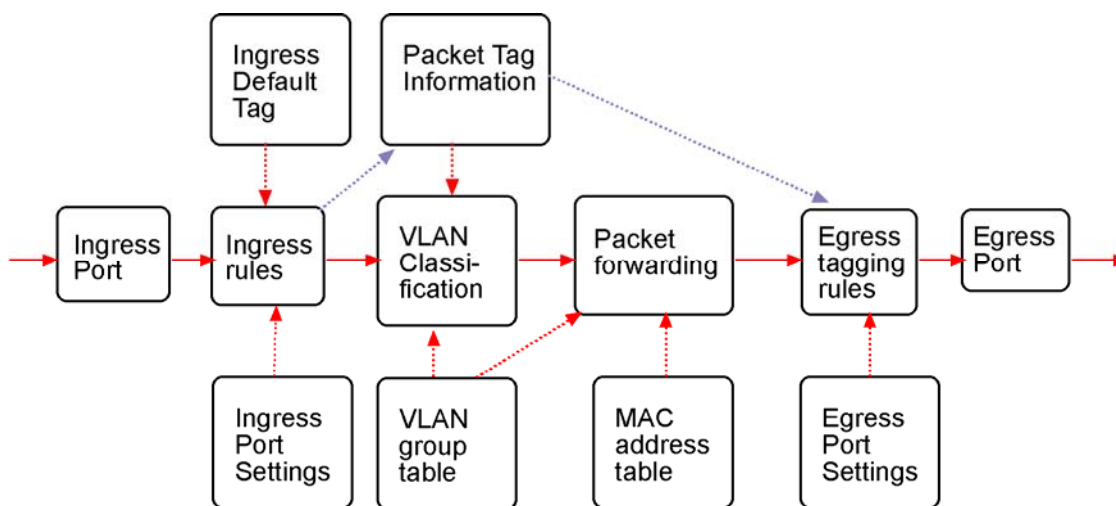

The following sections describe the VLAN processes and **Advanced VLAN mode** settings provided by the switch. A global setting means the setting is applied to all ports of the switch. A per port setting means each port can be configured for the setting respectively.

3.3.2 Ingress Rules

When a packet is received on an ingress port, the ingress rules are applied for packet filtering and packet tag removal. The related Ingress port settings are:

3.3.2.1 802.1Q Tag Aware Per port setting

Tag-aware - 802.1Q Tag Aware mode is used. The switch examines the tag content of every received packet. For a VLAN tagged packet, the packet VLAN tag data is retrieved as packet tag information for VLAN classification and egress tagging operation. For untagged packet and priority-tagged packet, port-based mode is used.

Tag-ignore - Port-based mode is used. The switch ignores the tag content of every received packet. Ingress Port Default Tag is always used as packet tag information for VLAN classification.

3.3.2.2 Keep Tag Per port setting

Enable - The VLAN tag in the received VLAN tagged packet will be kept as it is and is not stripped in whole forwarding operation.

Disable - The VLAN tag data in the received VLAN tagged packet is stripped (removed).

3.3.2.3 Drop Untagged Per Port Setting

Enable - All untagged packets and priority-tagged packets are dropped. A priority-tagged packet is treated as an untagged packet in this switch. Only VLAN-tagged packets are admitted.

Disable - Disable Untagged packet filtering

3.3.2.4 Drop Tagged Per Port Setting

Enable - All VLAN-tagged packets are dropped. A priority-tagged packet is treated as an untagged packet in this switch. Only untagged packets are admitted.

Disable - Disable VLAN-tagged packet filtering

3.3.3 Ingress Default Tag Per Port Setting

Each port can be configured with one Ingress Default Tag. This ingress port default tag is used when ingress port is in *Tag-ignore* mode or for the received untagged packets in *Tag-aware* mode. The Ingress Default Tag includes **PVID**, **CFI** and **User Priority** configuration.

When Ingress port default tag is used, it is copied as packet associated Packet Tag Information for VLAN classification. The PVID is used as index to one VLAN group in VLAN group table.

3.3.4 Packet Tag Information

Under VLAN process, every packet is associated with one Packet's Tag information in packet forwarding operation. The tag information includes VID, CFI and User Priority data and is used for two purposes:

- The VID in tag is used as index for VLAN classification.
- The tag is used for egress tag insertion if egress tagging is enabled.

The following table lists how the Packet Tag information is generated:

Tag Aware setting	Received Packet Type	Packet Tag information source
<i>Tag-ignore</i>	Untagged packet	Ingress Port Default Tag
<i>Tag-ignore</i>	Priority-tagged packet	Ingress Port Default Tag

<i>Tag-ignore</i>	VLAN-tagged packet	Ingress Port Default Tag
<i>Tag-aware</i>	Untagged packet	Ingress Port Default Tag
<i>Tag-aware</i>	Priority-tagged packet	Ingress Port Default Tag
<i>Tag-aware</i>	VLAN-tagged packet	Received packet VLAN Tag

3.3.5 VLAN Group Table Configuration

The switch provides a table of eight VLAN groups to support up to eight VLANs at the same time. Each VLAN group is associated to one unique VLAN. The table is referred for VLAN classification.

A VLAN group contains the following configuration settings:

VID: 12-bit VLAN Identifier index to the VLAN to which the group is associated

Member Ports: the admitted egress ports for packets belonging to this VLAN

Source Port Check: the ingress port of the packet must also be the member port of this VLAN. Otherwise, the packet is discarded.

3.3.6 VLAN Classification

VLAN classification is a process to classify a VLAN group to which a received packet belongs. The VID of the generated Packet Tag information associated to the received packet is used as an index for VLAN group table lookup. The VID matched VLAN group will be used for packet forwarding. If no matched VLAN group is found in table lookup, the packet is dropped.

Refer to section 3.2.4 for details about how the Packet Tag information is generated.

The member ports specified in the matched VLAN group are the admitted egress port range for the packet. The packet will never be forwarded to other ports which are not in the member ports.

The Source Port Check setting of the matched VLAN group is also referred. If it is enabled, the ingress port will be checked whether it is a member port of this group.

3.3.7 Packet Forwarding

The forwarding is a process to forward the received packet to one or more egress ports. The process uses the following information as forwarding decision:

- Member ports of the matched VLAN group: the egress port range for forwarding
- Source Port Check setting of the matched VLAN group: check ingress port membership

- Packet destination MAC address: for MAC address table loop up
- Switch MAC address table: to find the associated port where a MAC address is learned

If the MAC address table lookup is matched and the learned port is the VLAN member port, the packet is forwarded to the port (egress port). If the lookup failed, the switch will broadcast the packet to all member ports.

3.3.8 Egress Tagging Rules

Egress Tagging rules are used to make change to the packet before it is stored into egress queue of an egress port. Three egress settings are provided for each port and are described as follows:

3.3.8.1 Egress Settings

Insert Tag (per port setting)

Enable - Insert the Tag data of the associated Packet Tag information into the packet

Disable - No tagging is performed.

Untagging Specific VID (per port setting)

Enable - No tag insertion if the VID data of the associated Packet Tag information matches the Untagged VID configured in next setting even **[Insert Tag]** is enabled.

Disable - This rule is not applied.

3.3.9 Summary of VLAN Function

VLAN Modes

Port-based VLAN Mode: simple port-based 2-VLAN-groups mode

Port-based VLAN ISP Mode: simple port-based 5-VLAN-groups mode

Advanced VLAN Mode: Full VLAN configuration for port-based and Tag-based VLAN

Advanced VLAN Mode

Egress Settings (per port): [Tag Aware], [Keep Tag], [Drop Untag], [Drop Tag]

Ingress Default Tag (per port): [PVID], [CFI], [User Priority]

VLAN Groups (global): 8 VLAN groups

VLAN Group Settings (per group): [VID], [Member Ports], [Source Port Check]

Egress Settings: [Insert Tag], [Untagging Specific VID], [Untagged VID]

VLAN range supported: 1 ~ 4095 (eight VLANs at the same time)

[PVID] [VID] [Untagged VID] value range: 1 ~ 4095

3.4 802.1X Authentication

For some IEEE 802 LAN environments, it is desirable to restrict access to the services offered by the LAN to those users and devices that are permitted to make use of those services. IEEE 802.1X Port-based network access control function provide a means of authenticating and authorizing devices attached to a LAN port that has point-to-point connection characteristics, and of preventing access to that port in cases in which the authentication and authorization process fails. The 802.1X standard relies on the client to provide credentials in order to gain access to the network. The credentials are not based on a hardware address. Instead, they can be either a username/password combination or a certificate. The credentials are not verified by the switch but are sent to a Remote Authentication Dial-In User Service (RADIUS) server, which maintains a database of authentication information. 802.1X consists of three components for authentication exchange, which are as follows:

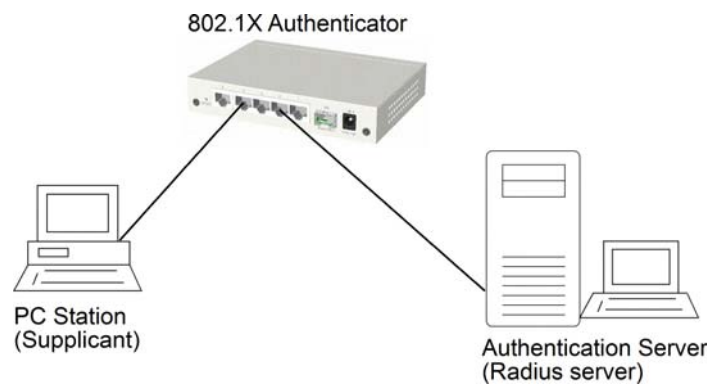

- An 802.1X authenticator: This is the port on the switch that has services to offer to an end device, provided the device supplies the proper credentials.
- An 802.1X supplicant: This is the end device; for example, a PC that connects to a switch that is requesting to use the services (port) of the device. The 802.1X supplicant must be able to respond to communicate.
- An 802.1X authentication server: This is a RADIUS server that examines the credentials provided to the authenticator from the supplicant and provides the authentication service. The authentication server is responsible for letting the authenticator know if services should be granted.

The 802.1X authenticator operates as a go-between with the supplicant and the authentication server to provide services to the network. When a switch is configured as an authenticator, the ports of the switch must then be configured for authorization. In an authenticator-initiated port authorization, a client is powered up or plugs into the port, and the authenticator port sends an Extensible Authentication Protocol (EAP) PDU to the supplicant requesting the identification of the supplicant. At this point in the process, the port on the switch is connected from a physical standpoint; however, the 802.1X process has not authorized the port and no frames are passed from the port on the supplicant into the switching engine. If the PC attached to the switch did not understand the EAP PDU that it was receiving from the switch, it would not be able to send an ID and the port would remain unauthorized. In this state, the port would never pass any user traffic and would be as good as disabled. If the client PC is running the 802.1X EAP, it would respond to the request with its configured ID.

(This could be a username/password combination or a certificate.)

After the switch, the authenticator receives the ID from the PC (the supplicant). The switch then passes the ID information to an authentication server (RADIUS server) that can verify the identification information. The RADIUS server responds to the switch with either a success or failure message. If the response is a success, the port will be authorized and user traffic will be allowed to pass through the port like any switch port connected to an access device. If the response is a failure, the port will remain unauthorized and, therefore, unused. If there is no response from the server, the port will also remain unauthorized and will not pass any traffic.

4. Web Management

The switch features an http server which can serve the management requests coming from any web browser software over TCP/IP network.

Web Browser

Compatible web browser software with JAVA script support
Microsoft Internet Explorer 4.0 or later

Set IP Address for the System Unit

Before the switch can be managed from a web browser software, make sure a unique IP address is configured for the switch.

4.1 Start Browser Software and Making Connection

Start your browser software and enter the IP address of the switch unit to which you want to connect. The IP address is used as URL for the browser software to search the device.

URL: `http://xxx.xxx.xxx.xxx/`

Factory default IP address: 192.168.0.2

4.2 Login to the Switch Unit

When browser software connects to the switch unit successfully, a Login screen is provided for you to login to the device as the left display below:

Gigabit Ethernet Switch

Please enter password to login

Password:

Configuration

- System
- Ports
- VLAN
- Aggregation
- LACP
- RSTP
- 802.1X
- Mirroring

The switch will accept only one successful management connection at the same time. The other connection

attempts will be prompted with a warning message as the right display above.



A new connection will be accepted when the current user logout successfully or auto logout by the switch due to no access for time out of 3 minutes.

System Configuration is displayed after a successful login.

4.3 Main Management Menu

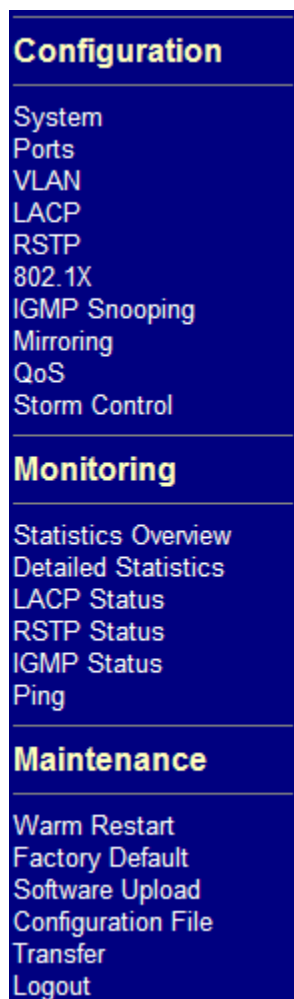

Configuration

System	Switch information, system and IP related settings
Ports	Port link status, port operation mode configuration
VLAN	VLAN related configuration
LACP	LACP configuration for port link aggregation

RSTP	RSTP (Rapid spanning tree protocol) related configuration
802.1X	802.1X authentication related configuration
IGMP Snooping	IGMP snooping related configuration
Mirroring	Port mirroring related configuration
QoS	Quality of Service related configuration
Storm Control	Packet Storm protection control configuration

Monitoring

Statistics Overview	List simple statistics for all ports
Detailed Statistics	List detailed statistics for all ports
LACP Status	LACP port status
RSTP Status	RSTP protocol status
IGMP Status	IGMP snooping status
Ping	Ping command from the switch to other IP devices

Maintenance

Warm Restart	Command to reboot the switch
Factory Default	Command to restore the switch with factory default settings
Software Upload	Command to update the switch firmware
Configuration File Transfer	Save and restore configuration file
Logout	Command to logout from the switch management

4.4 System

System Configuration

MAC Address	00-40-F6-EA-0E-8E
S/W Version	1.081
H/W Version	1.0
Active IP Address	192.168.0.210
Active Subnet Mask	255.255.255.0
Active Gateway	192.168.0.1
DHCP Server	0.0.0.0
Lease Time Left	0 secs

DHCP Enabled	<input type="checkbox"/>
Fallback IP Address	<input type="text" value="192.168.0.210"/>
Fallback Subnet Mask	<input type="text" value="255.255.255.0"/>
Fallback Gateway	<input type="text" value="192.168.0.1"/>
Management VLAN	<input type="text" value="0"/>
Name	<input type="text"/>
Password	<input type="password" value="..."/>
Inactivity Timeout (secs)	<input type="text" value="300"/>
SNMP enabled	<input checked="" type="checkbox"/>
SNMP Trap destination	<input type="text" value="0.0.0.0"/>
SNMP Read Community	<input type="text" value="public"/>
SNMP Write Community	<input type="text" value="private"/>
SNMP Trap Community	<input type="text" value="public"/>

Configuration	Description
MAC Address	The MAC address factory configured for the switch It can not be changed in any cases.
S/W Version	The firmware version currently running
H/W Version	The hardware version currently operating
Active IP Address	Currently used IP address for the switch management
Active Subnet Mask	Currently used subnet mask for IP address for the switch management
Active Gateway	Currently used gateway IP address for the switch management
DHCP Server	Current IP address of the DHCP server
Lease Time Left	The time left for the lease IP address currently used
DHCP Enabled	Use DHCP to get dynamic IP address configuration for the switch
Fallback IP Address	IP address used when DHCP mode is not enabled
Fallback Subnet Mask	Subnet mask for IP address used when DHCP mode is not enabled
Fallback Gateway	Default gateway IP address used when DHCP mode is not enabled
Management VLAN	Set management VLAN ID for web management to the switch
Name *	Set system name for this switch unit
Password	Set new password
SNMP enabled	Enable SNMP agent
SNMP Trap destination	The IP address of the SNMP trap manager
SNMP Read community	The community allowed for the SNMP [get] message
SNMP Write community	The community allowed for the SNMP [set] message
SNMP Trap community	The community used for the SNMP trap messages sent by the switch
[Apply]	Click to apply the configuration change
[Refresh]	Click to refresh current configuration

Note:

- 1. It is suggested to give each switch unit a system name as an alternative unique identification beside IP address.*
- 2. Setting change of DHCP mode takes effective in next bootup.*

4.4.1 Management VLAN

Management VLAN settings allow administrator to access the switch and perform the switch management over a dedicated VLAN.

The following rules are applied with the Management VLAN:

1. If the VLAN function is disabled, Management VLAN setting is ignored and no VLAN limitation is applied in accessing the switch web management interface.
2. If [Management VLAN] setting is zero, no VLAN limitation is applied in accessing the switch web management interface.
3. If [Management VLAN] setting is not zero, the switch web (http) server only replies to the management hosts located in the matched VLAN group. That means the egress port will be limited in the member ports of the matched VLAN group.
4. The switch web (http) server can only accept untagged management accessing packets and replies the management host with untagged packets.
5. The system will cross-check the VLAN group table and reject un-existing VLAN setting during configuring Management VLAN value.
6. If VLAN groups configuration causes a result that no VLAN group matches the management VLAN setting, the management VLAN setting will be reset to zero by the system automatically.

Notes:

1. *To apply management VLAN function, be sure to configure a VLAN group that matches the management VID first.*
2. *No matter how management VLAN is configured, login password authentication is still required.*

4.5 Ports

Port Configuration

Enable Jumbo Frames	<input type="checkbox"/>		
Power Saving Mode:	Disable ▾		
Port	Link	Mode	Flow Control
1	1000FDX	Auto Speed ▾	<input type="checkbox"/>
2	Down	Auto Speed ▾	<input type="checkbox"/>
3	Down	Auto Speed ▾	<input type="checkbox"/>
4	Down	Auto Speed ▾	<input type="checkbox"/>
5	Down	Auto Speed ▾	<input type="checkbox"/>
6	Down	Auto Speed ▾	<input type="checkbox"/>
7	Down	Auto Speed ▾	<input type="checkbox"/>
8	Down	Auto Speed ▾	<input type="checkbox"/>
Drop frames after excessive collisions	<input type="checkbox"/>		
SFP DDM			
Apply	Refresh		

Configuration	Function								
Enable Jumbo Frames	Select to enable jumbo frame support								
Power Saving Mode	<i>Full</i> – all the time <i>Link-up</i> – power saving only when link up <i>Link-down</i> – power saving only when link down <i>Disable</i> – disable port power saving								
Port	The port number								
Link	<i>Speed and duplex status with green background</i> - port is link on <i>Down with red background</i> - port is link down								
Mode	Select port operating mode <i>Disabled</i> - disable the port operation <table border="1"> <thead> <tr> <th><i>Mode</i></th> <th><i>Auto-negotiation</i></th> <th><i>Speed capability</i></th> <th><i>Duplex capability</i></th> </tr> </thead> <tbody> <tr> <td><i>Auto</i></td> <td><i>Enable</i></td> <td><i>10, 100, 1000M</i></td> <td><i>Full, Half</i></td> </tr> </tbody> </table>	<i>Mode</i>	<i>Auto-negotiation</i>	<i>Speed capability</i>	<i>Duplex capability</i>	<i>Auto</i>	<i>Enable</i>	<i>10, 100, 1000M</i>	<i>Full, Half</i>
<i>Mode</i>	<i>Auto-negotiation</i>	<i>Speed capability</i>	<i>Duplex capability</i>						
<i>Auto</i>	<i>Enable</i>	<i>10, 100, 1000M</i>	<i>Full, Half</i>						

<i>10 Half</i>	<i>Disable</i>	<i>10M</i>	<i>Half</i>
<i>10 Full</i>	<i>Disable</i>	<i>10M</i>	<i>Full</i>
<i>100 Half</i>	<i>Disable</i>	<i>100M</i>	<i>Half</i>
<i>100 Full</i>	<i>Disable</i>	<i>100M</i>	<i>Full</i>
<i>1000 Full</i>	<i>Enable</i>	<i>1000M</i>	<i>Full</i>
<i>Auto 1000 Full</i>	<i>Enable</i>	<i>1000M</i>	<i>Full</i>

Flow Control Set port flow control function
 v - set to enable 802.3x pause flow control for ingress and egress

Drop frame after excessive collision
 Check to enable the function.

[SFP DDM] Click to display DDM information and status of the SFP transceivers.
 [Apply] Click to apply the configuration change.

4.5.1 SFP DDM Status

DDM (Digital Diagnostic Monitoring) information and status are provided in some SFP transceivers. Part of the information are retrieved and listed as follows:

SFP DDM

Port	8
Identifier	SFP transceiver
Connector	LC
SONET Compliance	N/A
GbE Compliance	1000BASE-LX
Vendor Name	APAC Opto
Vendor OUI	000F99
Temperature	43.16 (C)
Voltage	3.40 (V)
TX Power	-5.66 (dBm)

Information	Function
Port	Port number which has SFP slot
Identifier	The identifier information of the transceiver
Connector	The connector type used on the transceiver
SONET Compliance	SONET compliance information of the transceiver
GbE Compliance	Gigabit Ethernet compliance information of the transceiver

Vendor Name	The vendor name of the transceiver
Vendor OUI	The vendor OUI of the transceiver
Temperature	The current temperature sensed inside the transceiver
Voltage	The working voltage sensed inside the transceiver
TX Power	The transmission optical power sensed (Unit: dBm)

[Refresh] Click to refresh current configuration.

[Back] Click to back to previous page.

Note: "N/A" - The information is not available.

4.6 VLANs

VLAN Configuration

- VLAN Disable**
- Port-based VLAN Mode** > [Setting](#)
- Port-based VLAN ISP Mode** > [Setting](#)
- Advanced VLAN Mode** > [Setting](#)

Remark

Click [Apply] will make your selection effect immediately.
Any improper configuration might cause network connection problem.
Refer to operation manual before making VLAN configuration.

Note

All members of a trunk group if configured must be in same VLAN group and have same all per-port VLAN settings.

VLAN Configuration	Description
VLAN Disable	Select to disable VLAN function All ports are allowed to communicate with each others freely with no VLAN limitation.
Port-based VLAN Mode	Simple configuration for 2 port-based VLAN groups
Port-based VLAN ISP Mode	Simple configuration for 7 port-based VLAN groups
Advance VLAN Mode	Full VLAN configuration for port-based and Tag-based VLAN

[Apply] Click to apply the configuration change.

[Refresh] Click to refresh current configuration.

4.6.1 Port-based VLAN Mode

VLAN Configuration

Port-based VLAN Mode

Group	Member ports							
	1	2	3	4	5	6	7	8
1	<input checked="" type="checkbox"/>	<input checked="" type="checkbox"/>	<input checked="" type="checkbox"/>	<input checked="" type="checkbox"/>	<input checked="" type="checkbox"/>	<input checked="" type="checkbox"/>	<input checked="" type="checkbox"/>	<input checked="" type="checkbox"/>
2	<input type="checkbox"/>	<input type="checkbox"/>	<input type="checkbox"/>	<input type="checkbox"/>	<input type="checkbox"/>	<input type="checkbox"/>	<input type="checkbox"/>	<input type="checkbox"/>

Remark

1. Two port-based VLAN groups are created.
2. The member ports in group can communicate with each other.
3. No packet modification from ingress to egress.
4. Member port overlap is allowed.

Configuration	Description
Group 1, 2	Port-based VLAN group number
Member ports	Select member ports for the group

[Apply]	Click to apply the configuration change
[Refresh]	Click to refresh current configuration
[Back]	Click to go back to upper menu

Operation in this mode:

1. The member ports of two groups are allowed to overlap.
2. The member ports in same group can communicate with other members only.
3. No packet tag is examined.
4. A received packet will not be modified (i.e. tagging or untagging) through VLAN operation till it is transmitted.

4.6.2 Port-based VLAN ISP Mode

VLAN Configuration

Port-based VLAN ISP Mode

Joint port

Remark

1. 7 port-based VLAN groups are created. Each includes 2 member ports.
2. Joint port is the overlap among all 7 groups.
3. The member ports in group can communicate with each other.
4. No packet modification from ingress to egress.

Example

P8 is joint port.
Groups : [P1,P8] [P2,P8] [P3,P8] [P4,P8] [P5,P8] [P6,P8] [P7,P8] are created.

Configuration	Description
Joint port	Select a port as the joint port for all 7 port-based VLAN groups
[Apply]	Click to apply the configuration change
[Refresh]	Click to refresh current configuration
[Back]	Click to go back to upper menu

Example:

If Port 8 is selected as the joint port, the 7 port-based VLAN groups are configured as follows automatically:

Group 1 - member [Port 1, Port 8]

Group 2 - member [Port 2, Port 8]

Group 3 - member [Port 3, Port 8]

Group 4 - member [Port 4, Port 8]

Group 5 - member [Port 5, Port 8]

Group 6 - member [Port 6, Port 8]

Group 7 - member [Port 7, Port 8]

Mode Operation:

1. The joint port is the shared member port for all groups.
2. Two member ports are configured in each group.
3. The member ports in same group can communicate with other only.
4. No packet tag is examined.
5. A received packet will not be modified (i.e. tagging or untagging) through VLAN operation till it is transmitted.

4.6.3 Advanced VLAN Mode

Advanced VLAN Mode

Ingress Default Tag	Ingress Settings	Egress Settings	VLAN Groups
---------------------	------------------	-----------------	-------------

Ingress Default Tag

Port	PVID	CFI	User Priority
1	<input type="text" value="1"/>	<input type="text" value="0"/>	<input type="text" value="0"/>
2	<input type="text" value="1"/>	<input type="text" value="0"/>	<input type="text" value="0"/>
3	<input type="text" value="1"/>	<input type="text" value="0"/>	<input type="text" value="0"/>
4	<input type="text" value="1"/>	<input type="text" value="0"/>	<input type="text" value="0"/>
5	<input type="text" value="1"/>	<input type="text" value="0"/>	<input type="text" value="0"/>
6	<input type="text" value="1"/>	<input type="text" value="0"/>	<input type="text" value="0"/>
7	<input type="text" value="1"/>	<input type="text" value="0"/>	<input type="text" value="0"/>
8	<input type="text" value="1"/>	<input type="text" value="0"/>	<input type="text" value="0"/>

Apply	Refresh	Back
-------	---------	------

Configuration	Description
Ingress Default Tag	Click to configure per port Ingress Default Tag settings
Ingress Settings	Click to configure per port ingress settings
Egress Settings	Click to configure per port egress settings
VLAN Groups	Click to configure VLAN group table

4.6.3.1 Ingress Default Tag

Configuration	Description
Port	Port number
PVID	Port VID, VID for Ingress Default Tag <i>1 ~ 4095</i> - decimal 12-bit VID value
CFI	CFI for Ingress Default Tag <i>0, 1</i> - 1-bit CFI value
User Priority	User priority for Ingress Default Tag <i>0 ~ 7</i> - decimal 3-bit value
[Apply]	Click to apply the configuration change
[Refresh]	Click to refresh current configuration
[Back]	Click to go back to upper menu

PVID is used as index for VLAN classification (VLAN group table lookup) in one of the following conditions:

1. Ingress port [Tag Aware] setting = *Tag-ignore*
2. Ingress port [Tag Aware] setting = *Tag-aware*
and the received packet is untagged or priority-tagged

[PVID+CFI+User Priority] = Ingress Default Tag for the ingress port

It is used as the tag for insertion in egress tagging operation in one of the following conditions:

1. Ingress port [Tag Aware] setting = *Tag-ignore*, Egress port [Insert Tag] = *Enable*
2. Ingress port [Tag Aware] setting = *Tag-aware*, Egress port [Insert Tag] = *Enable*
and the received packet is untagged or priority-tagged

4.6.3.2 Ingress Settings

Ingress Settings

Port	Tag Aware	Keep Tag	Drop Untag	Drop Tag
1	Tag-ignore ▼	Enable ▼	Disable ▼	Disable ▼
2	Tag-ignore ▼	Enable ▼	Disable ▼	Disable ▼
3	Tag-ignore ▼	Enable ▼	Disable ▼	Disable ▼
4	Tag-ignore ▼	Enable ▼	Disable ▼	Disable ▼
5	Tag-ignore ▼	Enable ▼	Disable ▼	Disable ▼
6	Tag-ignore ▼	Enable ▼	Disable ▼	Disable ▼
7	Tag-ignore ▼	Enable ▼	Disable ▼	Disable ▼
8	Tag-ignore ▼	Enable ▼	Disable ▼	Disable ▼

Apply Refresh Back

Remark

1. [Tag Aware]

Tag-aware : Use packet's tag VID (if exists and VID>0) for VLAN lookup

Tag-ignore : Use ingress default tag PVID for VLAN lookup

2. [Keep Tag]

Disable : Packet's tag is removed (if exists and VID>0)

Enable : Packet's tag is not removed

Configuration	Description
Port	Port number
Tag Aware	Check tag data for every received packet <i>Tag-aware</i> - set to activate Tag-based mode <i>Tag-ignore</i> - set to use port-based mode and ignore any tag in packet
Keep Tag	Tag is removed from the received packet if exists <i>Enable</i> - set to activate tag removal for VLAN-tagged packets <i>Disable</i> - set to disable tag removal function
Drop Untag	Drop all untagged packets and priority-tagged packets <i>Enable</i> - drop untagged packets and priority-tagged packets <i>Disable</i> - admit untagged packets and priority-tagged packets
Drop Tag	Drop all VLAN-tagged packets <i>Enable</i> - drop VLAN-tagged packets <i>Disable</i> - admit VLAN-tagged packets

[Apply] Click to apply the configuration change
[Refresh] Click to refresh current configuration

Note:

1. *Priority-tagged packet (VID=0) is treated as untagged packet in the switch.*
2. *[Tag Aware] setting affects the index used for VLAN classification (VLAN table lookup). The following table lists the index used:*

<u>Received packet type</u>	<i>Ingress [Tag Aware] setting</i>	
	<u>Tag-ignore</u>	<u>Tag-aware</u>
<i>Untagged</i>	<i>PVID</i>	<i>PVID</i>
<i>Priority-tagged (VID=0)</i>	<i>PVID</i>	<i>PVID</i>
<i>VLAN-tagged (VID>0)</i>	<i>PVID</i>	<i>Packet tag VID</i>

3. *Both [Drop Untag] and [Drop Tag] are set to Disable to admit all packets.*

4.6.3.3 Egress Settings

Egress Settings

Port	Insert Tag	Untagging Specific VID	Untagged VID
1	Disable ▾	Disable ▾	1
2	Disable ▾	Disable ▾	1
3	Disable ▾	Disable ▾	1
4	Disable ▾	Disable ▾	1
5	Disable ▾	Disable ▾	1
6	Disable ▾	Disable ▾	1
7	Disable ▾	Disable ▾	1
8	Disable ▾	Disable ▾	1

Apply Refresh Back

Remark

[Insert Tag] - egress tagging
Disable : no tag insertion
Enable : Insert tag to packet when egress

Source of Tag inserted:

Ingress Default Tag when [Tag Aware]=Tag-ignore
Received packet's Tag when [Tag Aware]=Tag-aware and VID>0

Note

If Ingress [Keep Tag] and egress [Insert Tag] are enabled,
Priority-tagged and VLAN-tagged packets will be double-tagged when egress.

Configuration	Description
Port	Port number
Insert Tag	Activate tagging (Insert a tag to the packet) <i>Enable</i> - set to activate tagging <i>Disable</i> - set to disable tagging function
Untagging Specific VID	No tag insertion if packet tag information matches [Untagged VID] <i>Enable</i> - set to enable this function <i>Disable</i> - set to disable this function
Untagged VID	VID for [Untagging Specific VID] setting <i>1 ~ 4095</i> - decimal 12-bit VID value
[Apply]	Click to apply the configuration change
[Refresh]	Click to refresh current configuration
[Back]	Click to go back to upper menu

The inserted tag sources when [Insert Tag] = *Enable* is listed as follows:

<u>Received packet type</u>	<u>[Tag Aware]=Tag-ignore</u>	<u>[Tag Aware]=Tag-aware</u>
<i>Untagged</i>	<i>Ingress Default Tag</i>	<i>Ingress Default Tag</i>
<i>Priority-tagged (VID=0)</i>	<i>Ingress Default Tag</i>	<i>Ingress Default Tag</i>
<i>VLAN-tagged (VID>0)</i>	<i>Ingress Default Tag</i>	<i>Packet own tag</i>

4.6.3.4 VLAN Groups

VLAN Groups

Group	VID	Member Ports								Source Port Check
		1	2	3	4	5	6	7	8	
1	1	<input checked="" type="checkbox"/>	<input checked="" type="checkbox"/>	<input checked="" type="checkbox"/>	<input checked="" type="checkbox"/>	<input checked="" type="checkbox"/>	<input checked="" type="checkbox"/>	<input checked="" type="checkbox"/>	<input checked="" type="checkbox"/>	Disable ▾
2	2	<input type="checkbox"/>	<input type="checkbox"/>	<input type="checkbox"/>	<input type="checkbox"/>	<input type="checkbox"/>	<input type="checkbox"/>	<input type="checkbox"/>	<input type="checkbox"/>	Disable ▾
3	3	<input type="checkbox"/>	<input type="checkbox"/>	<input type="checkbox"/>	<input type="checkbox"/>	<input type="checkbox"/>	<input type="checkbox"/>	<input type="checkbox"/>	<input type="checkbox"/>	Disable ▾
4	4	<input type="checkbox"/>	<input type="checkbox"/>	<input type="checkbox"/>	<input type="checkbox"/>	<input type="checkbox"/>	<input type="checkbox"/>	<input type="checkbox"/>	<input type="checkbox"/>	Disable ▾
5	5	<input type="checkbox"/>	<input type="checkbox"/>	<input type="checkbox"/>	<input type="checkbox"/>	<input type="checkbox"/>	<input type="checkbox"/>	<input type="checkbox"/>	<input type="checkbox"/>	Disable ▾
6	6	<input type="checkbox"/>	<input type="checkbox"/>	<input type="checkbox"/>	<input type="checkbox"/>	<input type="checkbox"/>	<input type="checkbox"/>	<input type="checkbox"/>	<input type="checkbox"/>	Disable ▾
7	7	<input type="checkbox"/>	<input type="checkbox"/>	<input type="checkbox"/>	<input type="checkbox"/>	<input type="checkbox"/>	<input type="checkbox"/>	<input type="checkbox"/>	<input type="checkbox"/>	Disable ▾
8	8	<input type="checkbox"/>	<input type="checkbox"/>	<input type="checkbox"/>	<input type="checkbox"/>	<input type="checkbox"/>	<input type="checkbox"/>	<input type="checkbox"/>	<input type="checkbox"/>	Disable ▾

Remark

[Source Port Check] - ingress port must be member port of the VLAN
Otherwise, packet is dropped.

Configuration	Description
Group	Group number
VID	VID of the VLAN to which this group is associated <i>1 ~ 4095</i> - decimal 12-bit VID value
Member Ports	Select the admitted egress ports for the packets belong to the VLAN <i>Port 1 ~ 8</i> - click to select
Source Port Check	Check whether the ingress port is the member port of the VLAN <i>Enable</i> - set to enable this check, the packet is dropped if ingress port is not member port of the VLAN. <i>Disable</i> - set to disable this check
[Apply]	Click to apply the configuration change
[Refresh]	Click to refresh current configuration
[Back]	Click to go back to upper menu

4.6.4 Important Notes for VLAN Configuration

Some considerations should be checked in configuring VLAN settings:

1. Switch VLAN Mode selection

It is suggested to evaluate your VLAN application first and plan your VLAN configuration carefully before applying it. Any incorrect setting might cause network problem.

2. Aggregation/Trunking configuration

Make sure the members of a link aggregation (trunk) group are configured with same VLAN configuration and are in same VLAN group.

3. Double Tagged in Advanced VLAN Mode

For a received packet, Ingress port [Keep Tag] setting and Egress port [Insert Tag] setting are enabled at the same time. It will cause the packet double-tagged when egress. Although, it is often applied in Q-in-Q provider bridging application, however, such condition should be avoided in normal VLAN configuration. See table below:

Ingress port	Egress port	Received Packet	Packet Transmitted
[Keep Tag]	[Insert Tag]		
<i>Enable</i>	<i>Enable</i>	Priority-tagged	Double-tagged
<i>Enable</i>	<i>Enable</i>	VLAN-tagged	Double-tagged

4.7 LACP

LACP Port Configuration

Port	Protocol Enabled	Key Value
1	<input type="checkbox"/>	auto
2	<input checked="" type="checkbox"/>	auto
3	<input checked="" type="checkbox"/>	auto
4	<input checked="" type="checkbox"/>	auto
5	<input checked="" type="checkbox"/>	auto
6	<input type="checkbox"/>	auto
7	<input type="checkbox"/>	auto
8	<input type="checkbox"/>	auto

Apply

Refresh

Configuration	Description
Port	Port number
Protocol Enabled	Enable LACP support for the port
Key Value	An integer value assigned to the port that determines which ports are aggregated into an LACP link aggregate. Set same value to the ports in same LACP link aggregate. Value: 1 ~ 255. <i>Auto</i> - key value is assigned by the system
[Apply]	Click to apply the configuration change
[Refresh]	Click to refresh current configuration

Notes:

1. This configuration is used to configure LACP aggregate groups.
2. The ports with same key value are in same LACP aggregate group.
3. The ports with Auto key are in same LACP aggregate group.

4.8 RSTP

RSTP System Configuration

System Priority	32768 ▾
Hello Time	2
Max Age	20
Forward Delay	15
Force version	Normal ▾

RSTP Port Configuration

Port	Protocol Enabled	Edge	Path Cost
Aggregations	<input type="checkbox"/>		
1	<input type="checkbox"/>	<input checked="" type="checkbox"/>	auto
2	<input type="checkbox"/>	<input checked="" type="checkbox"/>	auto
3	<input type="checkbox"/>	<input checked="" type="checkbox"/>	auto
4	<input type="checkbox"/>	<input checked="" type="checkbox"/>	auto
5	<input type="checkbox"/>	<input checked="" type="checkbox"/>	auto
6	<input type="checkbox"/>	<input checked="" type="checkbox"/>	auto
7	<input type="checkbox"/>	<input checked="" type="checkbox"/>	auto
8	<input type="checkbox"/>	<input checked="" type="checkbox"/>	auto

Configuration	Description
System Priority	The lower the bridge priority is the higher priority it has. Usually, the bridge with the highest bridge priority is the root. Value: 0 ~ 61440
Hello Time	Hello Time is used to determine the periodic time to send normal BPDU from designated ports among bridges. It decides how long a bridge should send this message to other bridge to tell I am alive.
Max Age	When the switch is the root bridge, the whole LAN will apply this setting as their maximum age time.
Forward Delay	This figure is set by Root Bridge only. The forward delay time is defined as the time spent from Listening state moved to Learning state and also from Learning state moved to Forwarding state of a port in bridge.

Force Version	Two options are offered for choosing STP algorithm. <i>Compatible</i> - STP (IEEE 802.1D) <i>Normal</i> - RSTP (IEEE 802.1w)
Aggregations	Enabled to support port trunking in STP. It means a link aggregate is treated as a physical port in RSTP/STP operation.
Port Protocol Enabled	Port is enabled to support RSTP/STP.
Port Edge	An Edge Port is a port connected to a device that knows nothing about STP or RSTP. Usually, the connected device is an end station. Edge Ports will immediately transit to forwarding state and skip the listening and learning state because the edge ports cannot create bridging loops in the network.
Port Path Cost	Specifies the path cost of the port that switch uses to determine which port are the forwarding ports the lowest number is forwarding ports, the range is 1 ~ 200,000,000 and <i>Auto</i> . <i>Auto</i> means a default cost is automatically calculated in RSTP operation based on the port link speed. The default costs are : <u>Link Speed</u> <u>Auto Default Cost</u> <i>10Mbps</i> <i>2000000</i> <i>100Mbps</i> <i>200000</i> <i>1000Mbps</i> <i>20000</i>
[Apply]	Click to apply the configuration change
[Refresh]	Click to refresh current configuration

4.9 802.1X Configuration

802.1X Configuration

Mode:

RADIUS IP:

RADIUS UDP Port:

RADIUS Secret:

Port	Admin State	Port State			
1	<input type="text" value="Force Authorized"/>	802.1X Disabled	Re-authenticate	Force Reinitialize	Statistics
2	<input type="text" value="Force Authorized"/>	802.1X Disabled	Re-authenticate	Force Reinitialize	Statistics
3	<input type="text" value="Force Authorized"/>	802.1X Disabled	Re-authenticate	Force Reinitialize	Statistics
4	<input type="text" value="Force Authorized"/>	802.1X Disabled	Re-authenticate	Force Reinitialize	Statistics
5	<input type="text" value="Force Authorized"/>	802.1X Disabled	Re-authenticate	Force Reinitialize	Statistics
6	<input type="text" value="Force Authorized"/>	802.1X Disabled	Re-authenticate	Force Reinitialize	Statistics
7	<input type="text" value="Force Authorized"/>	802.1X Disabled	Re-authenticate	Force Reinitialize	Statistics
8	<input type="text" value="Force Authorized"/>	802.1X Disabled	Re-authenticate	Force Reinitialize	Statistics
			Re-authenticate All	Force Reinitialize All	

Configuration	Description
Mode	<i>Disabled</i> - disable 802.1X function <i>Enabled</i> - enable 802.1X function
RADIUS IP	IP address of the Radius server
RADIUS UDP Port	The UDP port for authentication requests to the specified Radius server
RADIUS Secret	The encryption key for use during authentication sessions with the Radius server. It must match the key used on the Radius server.
Port	Port number
Admin State	Port 802.1X control <i>Auto</i> - set to the Authorized or Unauthorized state in accordance with the outcome of an authentication exchange between the Supplicant and the Authentication Server. <i>Force Authorized</i> - the port is forced to be in authorized state.

Port State

Force Unauthorized - the port is forced to be in unauthorized state.

Port 802.1X state

802.1X Disabled - the port is in 802.1X disabled state

Link Down - the port is in link down state

Authorized (green color) - the port is in 802.1X authorized state

Unauthorized (red color) - the port is in 802.1X unauthorized state

[Re-authenticate]	Click to perform a manual authentication for the port
[Force Reinitialize]	Click to perform an 802.1X initialization for the port
[Re-authenticate All]	Click to perform manual authentication for all ports
[Force Reinitialize All]	Click to perform 802.1X initialization for all ports
[Statistics]	Click to display 802.1X port statistic data
[Parameters]	Click to configure Re-authentication parameters
[Apply]	Click to apply the configuration change
[Refresh]	Click to refresh current configuration

4.9.1 802.1X Re-authentication Parameters

802.1X Parameters

Reauthentication Enabled	<input type="checkbox"/> Enabled
Reauthentication Period [1-3600 seconds]	3600
EAP timeout [1 - 255 seconds]	30

Configuration	Description
Re-authentication Enabled	Check to enable periodical re-authentication for all ports
Re-authentication Period	The period of time after which the connected radius clients must be re-authenticated (unit: second), Value: 1- 3600
EAP timeout	The period of time the switch waits for a supplicant response to an EAP request (unit: second), Value: 1 - 255

[Apply]	Click to apply the configuration change
[Refresh]	Click to refresh current configuration

4.10 IGMP Snooping

IGMP Configuration

IGMP Enabled	<input type="checkbox"/>
Router Ports	1 <input type="checkbox"/> 2 <input type="checkbox"/> 3 <input type="checkbox"/> 4 <input type="checkbox"/> 5 <input type="checkbox"/> 6 <input type="checkbox"/> 7 <input type="checkbox"/> 8 <input type="checkbox"/>
Unregistered IPMC Flooding enabled	<input checked="" type="checkbox"/>

VLAN ID	IGMP Snooping Enabled	IGMP Querying Enabled
1	<input checked="" type="checkbox"/>	<input checked="" type="checkbox"/>

Configuration	Description
IGMP Enabled	Check to enable global IGMP snooping.
Router Ports	Specify which ports have multicast router connected and require being forwarding IPMC packets unconditionally.
VLAN ID	List of current existing VLANs
IGMP Snooping Enabled	Check to enable IGMP snooping on the associated VLAN.
IGMP Querying Enabled	Check to enable IGMP querying on the associated VLAN.

[Apply]	Click to apply the configuration change
[Refresh]	Click to refresh current configuration

4.11 Mirroring

Mirroring Configuration

Port	Mirror Source
1	<input type="checkbox"/>
2	<input type="checkbox"/>
3	<input type="checkbox"/>
4	<input type="checkbox"/>
5	<input type="checkbox"/>
6	<input type="checkbox"/>
7	<input type="checkbox"/>
8	<input type="checkbox"/>

Mirror Port	<input type="text" value="1"/>
-------------	--------------------------------

Configuration	Description
Mirror Port	The port is forwarded all packets received on the mirrored ports
Mirror Source	Select the ports which will be mirrored all received packets to the mirror port.
[Apply]	Click to apply the configuration change
[Refresh]	Click to refresh current configuration

4.12 Quality of Service

QoS Configuration

Port	802.1p	DSCP	Port Priority
1	Disable	Disable	Class 3
2	Disable	Disable	Class 3
3	Disable	Disable	Class 3
4	Disable	Disable	Class 3
5	Disable	Disable	Class 3
6	Disable	Disable	Class 3
7	Disable	Disable	Class 3
8	Disable	Disable	Class 3

802.1p Mapping

DSCP Mapping

Service Policy

Apply

Refresh

Remark

1. 802.1p mode uses L2 packet's User Priority tag for priority classification.
2. DSCP mode uses L3 IP packet's DSCP value for priority classification.
3. 802.1p mode is superior over DSCP mode when both are enabled.
4. Port Priority is used when 802.1p and DSCP failed in classification.
5. Priority level : Class 3 > Class 2 > Class 1 > Class 0

QoS Configuration	Description
Port	Port number
802.1p	802.1p priority classification <i>Enable</i> - set to enable this classification to the port for priority-tagged and VLAN-tagged packets <i>Disable</i> - 802.1p classification is not applied to the port
DSCP	DSCP classification <i>Enable</i> - set to enable DSCP classification to the port for IP packets <i>Disable</i> - DSCP classification is not applied to the port
Port Priority	Port default priority class, it is used as a port-based QoS mode when 802.1p and DSCP classifications are disabled. It is also used as default priority class for the received packet when both 802.1p and DSCP classification failed in classification. <i>Class 3 ~ Class 0</i> - priority class

[802.1p Mapping]	Click to configure 802.1p mapping tables.
[DSCP Mapping]	Click to configure DSCP mapping table.
[Service Policy]	Click to configure per port egress service policy mode.
[Apply]	Click to apply the configuration change
[Refresh]	Click to refresh current configuration

Note:

802.1p classification is superior over DSCP classification if both are enabled. That means if a received packet is classified successfully in 802.1p classification, the classified priority class is used directly for the packet and the result of DSCP classification is ignored.

4.12.1 802.1p Mapping

QoS 802.1p Mapping

Port	tag 0	tag 1	tag 2	tag 3	tag 4	tag 5	tag 6	tag 7
1	Class 0	Class 0	Class 1	Class 1	Class 2	Class 2	Class 3	Class 3
2	Class 0	Class 0	Class 1	Class 1	Class 2	Class 2	Class 3	Class 3
3	Class 0	Class 0	Class 1	Class 1	Class 2	Class 2	Class 3	Class 3
4	Class 0	Class 0	Class 1	Class 1	Class 2	Class 2	Class 3	Class 3
5	Class 0	Class 0	Class 1	Class 1	Class 2	Class 2	Class 3	Class 3
6	Class 0	Class 0	Class 1	Class 1	Class 2	Class 2	Class 3	Class 3
7	Class 0	Class 0	Class 1	Class 1	Class 2	Class 2	Class 3	Class 3
8	Class 0	Class 0	Class 1	Class 1	Class 2	Class 2	Class 3	Class 3

Apply Refresh Back

Remark

1. Per port table : per User Priority tag value (0~7) maps to one priority class
2. Used to classify priority-tagged and VLAN-tagged packets

Configuration	Description
Port n	Port number n
tag m	3-bit User priority tag value m (range : 0 ~ 7)
Priority class	Mapped priority class for tag m on Port n <i>Class 3 ~ Class 0</i>

[Apply] Click to apply the configuration change

[Refresh] Click to refresh current configuration

[Back] Click to go back to upper menu

Every ingress port has its own 802.1p mapping table. The table is referred in 802.1p priority classification for the received packet.

4.12.2 DSCP Mapping

QoS DSCP Mapping

DSCP [0-63]	Priority
<input type="text"/>	Class 3 ▾
<input type="text"/>	Class 3 ▾
<input type="text"/>	Class 3 ▾
<input type="text"/>	Class 3 ▾
<input type="text"/>	Class 3 ▾
<input type="text"/>	Class 3 ▾
<input type="text"/>	Class 3 ▾
All others	Class 0 ▾

Remark

1. Table : per DSCP value (0~63) maps to one priority class
2. Used to classify L3 IP packets
3. All ports share same table.

Configuration	Description
DSCP [0-63]	Seven user-defined DSCP values which are configured with a priority class <i>0 ~ 63 - 6-bit DSCP value in decimal</i>
Priority	The priority class configured for the user-defined DSCP value <i>Class 3 ~ Class 0</i>
All others	The other DSCP values not in the seven user-defined values are assigned a default priority class <i>Class 3 ~ Class 0</i>

[Apply] Click to apply the configuration change

[Refresh] Click to refresh current configuration

[Back] Click to go back to upper menu

Only one DSCP mapping table is configured and applied to all ports. The table is referred in DSCP priority classification.

4.12.3 QoS Service Policy

QoS Service Policy

Port	Policy
1	Strict priority
2	Strict priority
3	Strict priority
4	Strict priority
5	Strict priority
6	Strict priority
7	Strict priority
8	Strict priority

Remark

1. Strict priority : high class is always served first till it is empty
2. Weighted ratio : 4 classes are served in round robin weighted ratio
3. Four classes are served with weighted guaranteed bandwidth on an egress port.

Configuration	Description
Port	Port number
Policy	Service policy for egress priority among four egress class queues <i>Strict priority</i> - high class queue is served first always till it is empty <i>Weighted ratio priority Class 3:2:1:0 = 4:3:2:1</i> - weighted ratio 4:3:2:1 <i>Weighted ratio priority Class 3:2:1:0 = 5:3:1:1</i> - weighted ratio 5:3:1:1 <i>Weighted ratio priority Class 3:2:1:0 = 1:1:1:1</i> - weighted ratio 1:1:1:1
[Apply]	Click to apply the configuration change
[Refresh]	Click to refresh current configuration
[Back]	Click to go back to upper menu

Notes:

1. *Queue with higher class number has higher priority than queue with lower class number. That means Class 3 > Class 2 > Class 1 > Class 0 by default.*
2. *In weighted ratio policies, a weighted fairness round robin service is guaranteed normally. However, when excess bandwidth exists higher class queue will take advantage on bandwidth allocation.*

4.13 Storm Control

Storm Control Configuration

Storm Control Number of frames per second	
Broadcast Rate	No Limit ▼
Multicast Rate	No Limit ▼
Flooded Unicast Rate	No Limit ▼

Configuration	Description
Broadcast Rate	The rate limit of the broadcast packets transmitted on a port.
Broadcast Rate	The rate limit of the Multicast packets transmitted on a port.
Flooded Unicast Rate	The rate limit of the flooded unicast packets transmitted on a port. The flooded unicast packets are those unicast packets whose destination address is not learned in the MAC address table.
[Apply]	Click to apply the configuration change
[Refresh]	Click to refresh current configuration

Notes:

- 1. The unit of the rates is pps (packets per second).*
- 2. No Limit - no protection control*

4.14 Statistics Overview

Statistics Overview for all ports

Clear

Refresh

Port	Tx Bytes	Tx Frames	Rx Bytes	Rx Frames	Tx Errors	Rx Errors
1	0	0	0	0	0	0
2	0	0	0	0	0	0
3	188022	360	138685469	584007	0	1
4	0	0	0	0	0	0
5	0	0	0	0	0	0
6	0	0	0	0	0	0
7	0	0	0	0	0	0
8	0	0	0	0	0	0

Statistics	Description
Port	Port number
Tx Bytes	Total of bytes transmitted on the port
Tx Frames	Total of packet frames transmitted on the port
Rx Bytes	Total of bytes received on the port
Rx Frames	Total of packet frames received on the port
Tx Errors	Total of error packet frames transmitted on the port
Rx Errors	Total of error packet frames received on the port

[Clear]	Click to reset all statistic counters
[Refresh]	Click to refresh all statistic counters

4.15 Detailed Statistics

Statistics for Port 1

Clear	Refresh	Port 1	Port 2	Port 3	Port 4	Port 5	Port 6	Port 7	Port 8																						
Receive Total				Transmit Total																											
Rx Packets	0	Tx Packets	0	Rx Octets	0	Tx Octets	0	Rx High Priority Packets	-	Tx High Priority Packets	-	Rx Low Priority Packets	-	Tx Low Priority Packets	-	Rx Broadcast	-	Tx Broadcast	-	Rx Multicast	-	Tx Multicast	-	Rx Broad- and Multicast	0	Tx Broad- and Multicast	0	Rx Error Packets	0	Tx Error Packets	0
Receive Size Counters				Transmit Size Counters																											
Rx 64 Bytes	-	Tx 64 Bytes	-	Rx 65-127 Bytes	-	Tx 65-127 Bytes	-	Rx 128-255 Bytes	-	Tx 128-255 Bytes	-	Rx 256-511 Bytes	-	Tx 256-511 Bytes	-	Rx 512-1023 Bytes	-	Tx 512-1023 Bytes	-	Rx 1024- Bytes	-	Tx 1024- Bytes	-								
Receive Error Counters				Transmit Error Counters																											
Rx CRC/Alignment	-	Tx Collisions	-	Rx Undersize	-	Tx Drops	-	Rx Oversize	-	Tx Overflow	-	Rx Fragments	-			Rx Jabber	-			Rx Drops	-										

Button	Description
[Port #]	Click to display the detailed statistics of Port #.
[Clear]	Click to reset all statistic counters
[Refresh]	Click to refresh the displayed statistic counters

4.16 LACP Status

LACP Aggregation Overview

Group/Port	1	2	3	4	5	6	7	8
Normal								
Group 2				1	2			
Group 3		1	2					

Aggregation Group 2	
Partner MAC Address	00-40-F6-EC-2E-2F
Local Ports Aggregated	4,5
Seconds since last change	10863
Aggregation Group 3	
Partner MAC Address	00-40-F6-EC-2D-87
Local Ports Aggregated	2,3
Seconds since last change	10911

Legend		
Down	Down	Port link down
0	Blocked	Port Blocked by RSTP. Number is Partner port number if other switch has LACP enabled
0	Learning	Port Learning by RSTP
Forwarding	Forwarding	Port link up and forwarding frames
0	Forwarding	Port link up and forwarding by RSTP. Number is Partner port number if other switch has LACP enabled

Refresh

Status	Description
Port	The port number
Normal	Display the ports not LACP enabled.
Group #	The LACP group
Status	<p>The LACP port status presented with color and a number</p> <p><Down> - the port is link down</p> <p><Blocked & #> - the port is blocked by RSTP and the # is the port number of LACP link partner</p> <p><Learning> - the port is learning by RSTP</p> <p><Forwarding> - the port is link up and forwarding frames</p> <p><Forwarding & #> - the port is link up and forwarding frames and the # is the port number of LACP link partner</p>
Partner MAC address	The MAC address of the link partner at the other end of the LACP aggregate
Local Port Aggregated	The ports at local end which are aggregated in same LACP group
[Refresh]	Click to refresh the status

Note: the figure shows an example that two LACP link aggregates are configured.

LACP Port Status

Port	Protocol Active	Partner Port Number	Operational Port Key
1	no		
2	yes	1	3
3	yes	2	3
4	yes	1	3
5	yes	2	3
6	no		
7	no		
8	no		

Status

Description

Port	The port number
Protocol Active	yes - the port is link up and in LACP operation no - the port is link down or not in LACP operation
Partner Port Number	The port number of the remote link partner
Operation Port Key	The operation key generated by the system

4.17 RSTP Status

RSTP VLAN Bridge Overview

VLAN Id	Bridge Id	Hello Time	Max Age	Fwd Delay	Topology	Root Id
1	32769:00-40-F6-EA-0E-A6	2	20	15	Steady	This switch is Root!

Refresh

RSTP Port Status

Port/Group	Vlan Id	Path Cost	Edge Port	P2p Port	Protocol	Port State
Port 1						Non-STP
Port 2						Non-STP
Port 3						Non-STP
Port 4						Non-STP
Port 5						Non-STP
Port 6						Non-STP
Port 7						Non-STP
Port 8						Non-STP

Status	Description
VLAN Id	The VLAN where a spanning tree network exists
Bridge ID	The Bridge ID of this Bridge instance.
Hello Time	Hello Time is used to determine the periodic time to send normal BPDU from designated ports among bridges. It decides how long a bridge should send this message to other bridge to tell I am alive.
Max Age	When the switch is the root bridge, the whole LAN will apply this setting as their maximum age time.
Fwd Delay	This figure is set by Root Bridge only. The forward delay time is defined as the time spent from Listening state moved to Learning state and also from Learning state moved to Forwarding state of a port in bridge.
Topology	The current state of the Topology Change Flag for this Bridge instance.
Root Id	The Bridge ID of the currently elected root bridge.
Port/Group	The port number or a LACP group
Vlan Id	The VLAN where a spanning tree network exists and the port is located
Path Cost	Specifies the path cost of the port that switch uses to determine which port are the forwarding ports the lowest number is forwarding ports, the range is 1 ~ 200,000,000 and <i>Auto</i> . <i>Auto</i> means a default cost is automatically calculated in RSTP operation

based on the port link speed.

The default costs are :

Link Speed Auto Default Cost

10Mbps 2000000

100Mbps 200000

1000Mbps 20000

Edge Port

An Edge Port is a port connected to a device that knows nothing about STP or RSTP. Usually, the connected device is an end station. Edge Ports will immediately transit to forwarding state and skip the listening and learning state because the edge ports cannot create bridging loops in the network.

P2P Port

A point-to-point port connects to a non-shared LAN media. The flag may be automatically computed or explicitly configured. The point-to-point properties of a port affect how fast it can transition STP state.

Protocol

Port status of RSTP/STP support

State

The current STP port state. The port state can be one of the following values:

Blocking, Learning, Forwarding, Non-STP.

4.18 IGMP Status

IGMP Status

VLAN ID	Querier	Queries transmitted	Queries received	v1 Reports	v2 Reports	v3 Reports	v2 Leaves
1	Idle	0	89	0	474	4	0

Refresh

Member Groups

VLAN ID	Groups	Port Members
1	224.0.1.60	1
1	239.255.255.250	1
1	224.0.0.251	1
1	224.0.0.252	1
1	224.0.1.22	1

Status	Description
VLAN ID	The VLAN ID of the entry.
Querier Status	Show the Querier status is "Active" or "Idle".
Queries transmitted	The number of Transmitted Queries.
Queries Received	The number of Received Queries.
V1 Reports	The number of Received V1 Reports.
V2 Reports	The number of Received V2 Reports.
V3 Reports	The number of Received V3 Reports.
V2 Leave	The number of Received V2 Leave.
[Refresh]	Click to refresh the page.

Group Member Status	Description
VLAN ID	The VLAN where the groups found
Groups	IPMC group (IP) found on the VLAN
Port Members	Port members found of the group

4.19 Ping

Ping Parameters

Target IP address	<input type="text"/>
Count	1 <input type="button" value="v"/>
Time Out (in secs)	1 <input type="button" value="v"/>

Ping Results	
Target IP address	0.0.0.0
Status	Test complete
Received replies	0
Request timeouts	0
Average Response Time (in ms)	0

Ping	Description
Target IP Address	The target IP address to which the ping command issues
Count	The number of ping commands generated
Time Out (in secs)	The time out for a reply (in seconds)
[Apply]	Start the ping command
Status	The command status
Received replies	The number of replies received by the system
Request time-outs	The number of requests time out
Average Response Time	The average response time of a ping request (in mini-seconds)

4.20 Warm Restart

Warm Restart

Are you sure you want to perform a Warm Restart?

This menu is used to reboot the switch unit remotely with current configuration. Starting this menu will make

your current http connection lost. You must rebuild the connection to perform any management operation to the unit.

4.21 Factory Default

Factory Default



This menu is used to restore all settings of the switch unit with factory default values except current IP configuration and Management VLAN configuration.

4.22 Software Update

Software Upload



This menu is used to perform in-band firmware (switch software) upgrade. Enter the path and file name of new firmware image file for uploading.

Configuration	Description
Filename	Path and filename (warp format)
[Browse]	Click to browse your computer file system for the firmware image file
[Upload]	Click to start upload

4.23 Configuration File Transfer

Configuration Upload

 瀏覽...

Configuration Download

Operation	Description
Configuration file	File name
[Browse]	Click to locate a configuration file.
[Upload]	Click to start upload for the specified configuration file.
[Download]	Click to save current configuration as the specified configuration file.

4.24 Logout

This command is used to force a logout immediately from the switch management and pop-up a login page. If current user does not perform any management operation over 3 minutes, the switch will execute an auto logout and abort the current connection.

Please enter password to login

5. SNMP Support

SNMP version support	Snmp v1, v2c management
Managed Objects	MIB-II
	system OBJECT IDENTIFIER ::= { mib-2 1 }
	interfaces OBJECT IDENTIFIER ::= { mib-2 2 }
	ip OBJECT IDENTIFIER ::= { mib-2 4 }
	snmp OBJECT IDENTIFIER ::= { mib-2 11 }
	rmon OBJECT IDENTIFIER ::= { mib-2 16 }
	dot1dBridge OBJECT IDENTIFIER ::= { mib-2 17 }
	ifMIB OBJECT IDENTIFIER ::= { mib-2 31 }
RFC	RFC 3418 - Management Information Base (MIB) for the Simple Network Management Protocol (SNMP)
	RFC 1907 - Management Information Base for Version 2 of the Simple Network Management Protocol (SNMPv2)
	RFC 1213 - Management Information Base for Network Management of TCP/IP-based internets: MIB-II
	RFC 1158 - Management Information Base for network management of TCP/IP-based internets: MIB-II
	RFC 1493 - Definitions of Managed Objects for Bridges
	RFC 2863 - The Interfaces Group MIB
	RFC 1573 - Evolution of the Interfaces Group of MIB-II
SNMP Trap Support	TRAP_COLDSTART - the device boot up trap
	TRAP_LINKUP - the port link recovery trap
	TRAP_LINKDOWN - port link down trap

Appendix. Factory Default Settings

System Configuration

DHCP Enabled	<i>Not select (disabled)</i>
Fallback IP Address	<i>192.168.0.2</i>
Fallback IP Subnet mask	<i>255.255.255.0</i>
Fallback Gateway IP	<i>192.168.0.1</i>
Management VLAN - VID	<i>0</i>
Management VLAN - CFI	<i>0</i>
Management VLAN - User priority	<i>0</i>
Name	<i>Null</i>
Inactivity Timeout	<i>300 seconds</i>
Password	<i>123</i>
SNMP enabled	<i>Not select (disabled)</i>
SNMP Trap destination	<i>0.0.0.0</i>
SNMP Read community	<i>public</i>
SNMP Write community	<i>private</i>
SNMP Trap community	<i>public</i>

Ports Configuration

Enable Jumbo Frames	<i>Not select (disabled)</i>
Mode	<i>Auto for all ports</i>
Flow Control	<i>v: Enable for all ports</i>
Port Type	<i>Port 8: RJ-45</i>

VLAN Configuration

Main Mode	<i>VLAN Disable</i>
-----------	---------------------

Port-based VLAN Mode setting

Member Ports	<i>Port 1, 2, 3, 4, 5, 6, 7, 8 for Group 1</i> <i>None for Group 2</i>
--------------	---------------------------------------------------------------------------

Port-based VLAN ISP Mode setting

Advanced VLAN Mode Settings

Ingress Default Tag - PVID	1 for all ports
Ingress Default Tag - CFI	0 for all ports
Ingress Default Tag - User Priority	0 for all ports
Ingress Setting - Tag Aware	Tag-ignore for all ports
Ingress Setting - Keep Tag	Enable for all ports
Ingress Setting - Drop Untag	Disable for all ports
Ingress Setting - Drop Tag	Disable for all ports
Egress Setting - Insert Tag	Disable for all ports
Egress Setting - Untagging VID	Disable for all ports
Egress Setting - Untagged VID	1 for all ports
VLAN Group 1 - VID	1
VLAN Group 1 - Member Ports	Port 1, 2, 3, 4, 5, 6, 7, 8
VLAN Group 1 - Source Port Check	Disable
VLAN Group 2 - VID	2
VLAN Group 2 - Member Ports	None
VLAN Group 2 - Source Port Check	Disable
VLAN Group 3 - VID	3
VLAN Group 3 - Member Ports	None
VLAN Group 3 - Source Port Check	Disable
VLAN Group 4 - VID	4
VLAN Group 4 - Member Ports	None
VLAN Group 4 - Source Port Check	Disable
VLAN Group 5 - VID	5
VLAN Group 5 - Member Ports	None
VLAN Group 5 - Source Port Check	Disable
VLAN Group 6 - VID	6
VLAN Group 6 - Member Ports	None
VLAN Group 6 - Source Port Check	Disable
VLAN Group 7 - VID	7

VLAN Group 7 - Member Ports *None*
VLAN Group 7 - Source Port Check *Disable*
VLAN Group 8 - VID *8*
VLAN Group 8 - Member Ports *None*
VLAN Group 8 - Source Port Check *Disable*

LACP Port Configuration

Protocol Enabled *Not select (disabled) for all ports*
Key Value *Auto for all ports*

RSTP System Configuration

System Priority *32768*
Hello Time *2*
Max Age *20*
Forward Delay *15*
Force Version *Normal*

RSTP Port Configuration

Protocol enabled *Not select (disabled) for all ports*
Edge *v: Select for all ports*
Max Age *20*
Forward Delay *15*
Force Version *Normal*

802.1X Configuration

Mode *Disabled*
RADIUS IP *0.0.0.0*
RADIUS UDP Port *1812*
RADIUS Secret *None*
Admin State *Force Authorized for all ports*
Reauthentication Enabled *No*
Reauthentication Period *3600*

EAP Timeout	30
Port 1~Port 8 - tag 1	Class 0
Port 1~Port 8 - tag 2	Class 1
Port 1~Port 8 - tag 3	Class 1
Port 1~Port 8 - tag 4	Class 2
Port 1~Port 8 - tag 5	Class 2
Port 1~Port 8 - tag 6	Class 3
Port 1~Port 8 - tag 7	Class 3

IGMP Snooping Configuration

IGMP Enabled	Disable
Router Ports	Not select for all ports
Unregistered IPMC Flooding Enabled	Enable
IGMP Snooping Enabled	Enabled for all VLANs
IGMP Querying Enabled	Enabled for all VLANs

Mirroring Configuration

Mirror source	Not select for all ports
Mirror Port	1 (Port 1)

Quality of Service Configuration

802.1p Classification	Disable for all ports
DSCP Classification	Disable for all ports
Port Priority	Class 3 for all ports

QoS 802.1p Mapping

Port 1~Port 8 - tag 0	Class 0
Port 1~Port 8 - tag 1	Class 0
Port 1~Port 8 - tag 2	Class 1
Port 1~Port 8 - tag 3	Class 1
Port 1~Port 8 - tag 4	Class 2

Port 1~Port 8 - tag 5	<i>Class 2</i>
Port 1~Port 8 - tag 6	<i>Class 3</i>
Port 1~Port 8 - tag 7	<i>Class 3</i>

QoS DSCP Mapping

DSCP 1 / Priority	<i>0, Class 0</i>
DSCP 2 / Priority	<i>0, Class 0</i>
DSCP 3 / Priority	<i>0, Class 0</i>
DSCP 4 / Priority	<i>0, Class 0</i>
DSCP 5 / Priority	<i>0, Class 0</i>
DSCP 6 / Priority	<i>0, Class 0</i>
DSCP 7 / Priority	<i>0, Class 0</i>
All others DSCP	<i>Class 0</i>

QoS Service Policy

Port 1	<i>Strict priority</i>
Port 2	<i>Strict priority</i>
Port 3	<i>Strict priority</i>
Port 4	<i>Strict priority</i>
Port 5	<i>Strict priority</i>
Port 6	<i>Strict priority</i>
Port 7	<i>Strict priority</i>
Port 8	<i>Strict priority</i>

Storm Control Configuration

Broadcast Rate	<i>No limit</i>
Multicast Rate	<i>No limit</i>
Flooded Unicast Rate	<i>No limit</i>