



10/100 Managed Fast Ethernet Switch with 100FX and Gigabit Connectivity

KS-2260
Optional 100FX Modules
Optional Gigabit Modules

Operation Manual

(C) 2002 KTI Networks Inc. All rights reserved. No part of this documentation may be reproduced in any form or by any means or used to make any directive work (such as translation or transformation) without permission from KTI Networks Inc.

KTI Networks Inc. reserves the right to revise this documentation and to make changes in content from time to time without obligation on the part of KTI Networks Inc. to provide notification of such revision or change.

For more information, contact:

United States

KTI Networks Inc.
P.O. BOX 631008
Houston, Texas 77263-1008

Phone: 713-2663891
Fax: 713-2663893
E-mail: kti@ktinet.com
URL: <http://www.ktinet.com/>

International

Fax: 886-2-26983873
E-mail: kti@ktinet.com.tw
URL: <http://www.ktinet.com.tw/>

The information contained in this document is subject to change without prior notice. Copyright (C). All Rights Reserved.

TRADEMARKS

Ethernet is a registered trademark of Xerox Corp.

WARNING:

This equipment has been tested and found to comply with the limits for a Class A digital device, pursuant to Part 15 of the FCC Rules. These limits are designed to provide reasonable protection against harmful interference when the equipment is operated in a commercial environment. This equipment generates, uses, and can radiate radio frequency energy and if not installed and used in accordance with the instruction manual may cause harmful interference in which case the user will be required to correct the interference at his own expense.

NOTICE:

- (1) The changes or modifications not expressly approved by the party responsible for compliance could void the user's authority to operate the equipment.
- (2) Shielded interface cables and AC power cord, if any, must be used in order to comply with the emission limits.

CISPR A COMPLIANCE:

This device complies with EMC directive of the European Community and meets or exceeds the following technical standard.

EN 55022 - Limits and Methods of Measurement of Radio Interference Characteristics of Information Technology Equipment. This device complies with CISPR Class A.

WARNING: This is a Class A product. In a domestic environment this product may cause radio interference in which case the user may be required to take adequate measures.

CE NOTICE

Marking by the symbol  indicates compliance of this equipment to the EMC directive of the European Community. Such marking is indicative that this equipment meets or exceeds the following technical standards:

EN 55022: Limits and Methods of Measurement of Radio Interference characteristics of Information Technology Equipment.

EN 50082/1: Generic Immunity Standard -Part 1: Domestic Commercial and Light Industry.

EN 60555-2: Disturbances in supply systems caused by household appliances and similar electrical equipment - Part 2: Harmonics.

Table of Contents

1. Introduction	8
1.1 Introduction	8
1.2 Features	9
1.3 Hardware Specifications	10
1.4 Software Specifications	12
1.4.1 Management Objects	13
1.4.2 SNMP Traps	14
1.5 Function Descriptions	15
1.5.1 LACP Trunking Function	15
1.5.2 IP Multicast Function	17
1.5.3 MAC Address Filtering Function	19
1.5.4 Static MAC Address	20
1.5.5 Port Security	20
1.5.6 VLAN Function	21
1.5.6.1 Port-based VLAN	21
1.5.6.2 IEEE 802.1Q VLAN (Tag-based VLAN)	22
1.5.6.3 Protocol-based VLAN	23
1.5.7 Spanning Tree Protocol	23
1.5.8 Port Sniffer Function	25
1.5.9 QoS Priority Function	26
1.5.10 802.1X Port-Based Network Access Control	27
2. Installation and Management	30
2.1 Panel Description	30
2.2 AC Power Supply	30
2.3 Network Switched Ports	31
2.3.1 10/100TX Ports	31
2.3.2 100FX Modules	32
2.3.3 Gigabit Ports and Modules	34
2.4 Rack Mounting	36
2.5 LED Indicators	37
2.6 Cooling Fans	38
2.7 Management Setup	39
2.7.1 Setup for Out-of-band (Console) Management	40
2.7.2 Setup for In-band Management	41
2.7.3 Quick Guide to Configure Switch IP Address	41
3. Console and Telnet Operation	42
3.1 Main Menu	44

3.2 Switch Static Configuration	46
3.2.1 Port Configuration	47
3.3.2 Trunk Configuration	49
3.3.3 VLAN Configuration	50
3.3.3.1 VLAN Configure	50
3.3.3.2 Create a VLAN Group	52
3.3.3.3 Edit / Delete a VLAN Group	54
3.3.3.4 Groups Sorted Mode	55
3.3.4 Misc Configuration	56
3.3.4.1 MAC Age Interval	56
3.3.4.2 Broadcast Storm Filtering	57
3.3.4.3 Max Bridge Transmit Delay Bound	58
3.3.4.4 Port Security	59
3.3.4.5 Collision Retry Forever	60
3.3.4.6 Hash Algorithm	60
3.3.5 Administration Configuration	61
3.3.5.1 Change Username	61
3.3.5.2 Change Password	62
3.3.5.3 Device Information	62
3.3.5.4 IP Configuration	63
3.3.6 Port Sniffer Configuration	64
3.3.7 Priority Configuration	65
3.3.7.1 Static Priority	66
3.3.7.2 802.1p Priority	67
3.3.8 MAC Address Configuration	68
3.3.8.1 Static MAC Address	68
3.3.8.2 Filtering MAC Address	70
3.4 Protocol Related Configuration	71
3.4.1 STP	71
3.4.2 SNMP	75
3.4.2.1 System Options	75
3.4.2.2 Community Strings	76
3.4.2.3 Trap Managers	77
3.4.3 GVRP	78
3.4.4 IGMP	78
3.4.5 LACP	79
3.4.5.1 Working Port Setting	79
3.4.5.2 State Activity	80
3.4.5.3 LACP Status	81

3.4.6 802.1X	81
3.4.6.1 Enable 802.1X Protocol	82
3.4.6.2 802.1X System Configuration	82
3.4.6.3 802.1X Per Port Configuration	83
3.4.6.4 802.1X Misc. Configuration	84
3.5 Status and Counters	85
3.5.1 Port Status	86
3.5.2 Port Counters	87
3.5.3 System Information	88
3.6 Reboot Switch	89
3.6.1 Restart	89
3.6.2 Default	89
3.7 TFTP Update Firmware	90
3.7.1 TFTP Update Firmware	91
3.7.2 TFTP Restore Configuration	92
3.7.3 TFTP Backup Configuration	93
4. SNMP Management	94
4.1 Configuring SNMP Settings via Console Operation	95
4.2 SNMP MIB-2 and Private MIB	95
4.3 SNMP Traps	98
5. Web Management	99
5.1 Start Browser Software and Making Connection	100
5.2 Web Management Home Overview	101
5.3 Port status	102
5.4 Port Statistics	104
5.5 Administrator	105
5.5.1 IP Address	106
5.5.2 Switch Setting	107
5.5.2.1 Basic Information	107
5.5.2.2 Module Info	108
5.5.2.3 Advanced	109
5.5.3 Console Port Information	112
5.5.4 Port Controls	113
5.5.5 Trunking	115
5.5.5.1 Aggregator settings	116
5.5.5.2 Aggregator Information	117
5.5.5.3 State Activity	120
5.5.6 Forwarding and Filtering Database	121

5.5.6.1 IGMP Snooping	121
5.5.6.2 Static MAC Address	122
5.5.6.3 MAC Address Filtering	123
5.5.7 VLAN configuration	124
5.5.7.1 Port-based VLAN	125
5.5.7.2 802.1Q VLAN	127
5.5.8 Spanning Tree	131
5.5.9 Port Sniffer	135
5.5.10 SNMP	136
5.5.11 Security Manager	139
5.5.12 802.1X Configuration	140
5.5.12.1 802.1X PerPort Configuration	142
5.5.12.2 802.1X Misc Configuration	143
5.5.13 Stack Settings	144
5.6 Stacking	146
5.7 TFTP Update Firmware	148
5.8 Configuration Backup	150
5.8.1 TFTP Restore Configuration	150
5.8.2 TFTP Backup Configuration	151
5.9 Reset System	152
5.10 Reboot	153
6. Update Firmware from Console	154
Appendix A: Factory Default Settings	155

1. Introduction

1.1 Introduction

Driven by recent advances in desktop computing technology, today's network applications have increased in speed, power and the ability to process information. To meet the demands of these more bandwidth-intensive applications, this switch device provides significant increase in performance for your Ethernet and Fast Ethernet network. The switch comes with high number of 10/100 Fast Ethernet switched ports, each capable of transferring information simultaneously at full wire speed to control and allocate the network bandwidth. It also provides two **Gigabit** Ethernet slots for migration to Gigabit network smoothly.

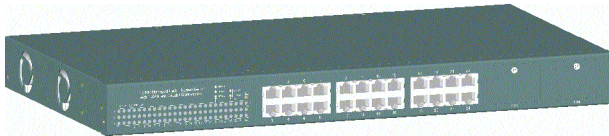

The key features of the switch units are:

- **High Port-count and High Bandwidth**
- **100FX connectivity**
- **Copper Gigabit connectivity**
- **Fiber Gigabit connectivity**
- **Network Management**

1.2 Features

- 19-inch rack mountable 24-Port 10/100 managed Fast Ethernet switch with two Giga expansion port slots
- Provides two alternative 100Base-FX port slots for fiber connections
- Non-blocking and store-and-forward switch engine performs forwarding and filtering at full wire speed.
- Supports diversified optional Giga port modules for selection including 10/100/1000 copper type and fiber type
- Provides port control function for auto-negotiation, speed, duplex, and flow control configuration
- Provides per-port Egress/Ingress data rate control function
- Provides 802.1X port-based network access control function
- Provides broadcast storm filtering function
- Provides 802.3ad port trunking function with up to 7 trunks
- Supports input-port-based, output-port-based, and input-output-pair-based Sniffer function
- Provides static MAC address and filtering MAC address configuration
- Provides ingress port security function
- Provides bridging delay bound control function
- Supports Ethernet frame length up to 1522 bytes
- Supports 802.3x flow control for full duplex mode and backpressure flow control for half duplex mode
- Supports auto-aging with selectable inter-age time
- Supports port-based VLAN and 802.1Q tag-based VLAN
- Supports 802.1v protocol-based VLAN classification
- Supports port-based priority and 802.1p CoS with 2-level priorities
- Supports Spanning Tree Protocol
- Supports IP Multicasting and IGMP snooping
- Supports stacking management function
- Supports console/Telnet/SNMP/Web/Trap managements

1.3 Hardware Specifications

10/100 Switched Ports	Port 1 ~ 24, Total : 24 ports 802.3 10Base-T, 802.3u 100Base-TX compliant Shielded RJ-45 with auto MDI-X function
Port 23, 24 Alternatives	100Base-FX connectivity 2 expansion module slots - Slot F23, F24
Giga Switched Ports	2 expansion Slots - Slot G1, G2 802.3z and 802.3ab compliant Supports optional 10/100/1000 Copper module Supports optional Giga Fiber modules
Port Control Function	Port enable/disable Auto-negotiation function Speed, Duplex mode Full duplex flow control function Half duplex flow control function Ingress data rate Egress data rate Port security (MAC learning function)
Flow Control Methods	802.3x pause frame based for full duplex Backpressure for half duplex mode
Forwarding speed	Max. 148,810 pps on 100M switched ports Max. 1,488,100 pps on Gigabit switched ports
Trunking Function	IEEE 802.3ad compliant Per trunk mode : Static or LACP Up to 7 trunk groups (trunk ports) Each is composed of up to 4 ports
Port Sniffing	One sniffer port (any one among 26 ports) Up to 25 monitored ports 3 mode options - Tx / Rx / Tx+Rx traffic
MAC address aging time	Control options - 300 ~ 765 seconds
MAC Address Table	Size : 6K entries for Auto-learned unicast addresses and Static unicast/multicast addresses
Broadcast Storm Filtering	Threshold options - 5%, 10%, 15%, 20%, 25%
Filtering MAC Address	Destination address-based filtering

Network Access Control Function	802.1X protocol support for all ports Radius client configuration Per port mode - Auto, Fu, Fa, No
QoS Function	2-level (High/Low) priority for Tx queues Selectable Tx High/Low service ratio
Priority Decision Method	First - Port-based priority Second - 802.1p priority (Tag priority value)
VLAN Function	Mode options if enabled - Port-based VLAN 802.1Q Tag-based VLAN
Port-based VLAN	Max. 26 VLAN groups VLAN-tagging is ignored No tag modification for tagged packets
802.1Q VLAN	Max. 256 VLAN groups
- VLANID	2 ~ 4094
- Member port mode	Outgoing : Tagged, Untagged
- GVRP	802.1Q complaint (GARP 802.1P complaint)
- Protocol classification	802.1v compliant
IP Multicasting Table	256 multicast address root entries
10/100 Port LED Display	Link / Activity status Speed status Duplex / Collision status
Giga Port LED Display	Link / Activity status Duplex / Collision status
Console Port	RS-232, DTE, DB9 Baud : 9600, N, 8, 1, 0, No flow control
Dimension	443mm (W) x 245mm (D) x 43mm (H)
Power Input Rating	100 ~ 240VAC, 50/60Hz, 50W
Input voltage range	90 ~ 264VAC
Input frequency	47 ~ 440Hz
Power Consumption	17W min. 26W max.
Environmental	Operating temperature : 0 ~ 50°C Storage temperature : -40 ~ 85°C
Certifications	FCC Part 15 Class A CE / CISPR Class A

1.4 Software Specifications

Management interface

In-band SNMP over TCP/IP network
In-band Web browser over TCP/IP network
In-band Telnet over TCP/IP network
Out-of-band via Console port
SNMP Traps over TCP/IP network

RFC & Protocols

IPv4	IP version4	RFC791
TCP	Transmission Control Protocol	RFC793
UDP	User Datagram Protocol	RFC768
ARP	Ethernet Address Resolution Protocol	RFC826
ICMP	Internet Control Message Protocol	RFC792
SNMP	SNMP agent v1	RFC1157
MIB-2	Standard MIB	RFC1213
Traps	Generic SNMP traps	RFC1157
TFTP	Trivial File Transfer Protocol	RFC1350
Telnet	Telnet protocol	RFC854
HTTP	HTTP server for web management	RFC1945
GVRP	GARP VLAN Registration Protocol	802.1Q
GARP	Generic attribute registration protocol	802.1P
DHCP	Dynamic Host Configuration Protocol	RFC2131
IGMP	Internet Group Management Protocol	RFC2236
RMON	MIB groups : Statistics, History, Alarm, Event	RFC1757
Bridge	Bridge MIB	RFC1493

1.4.1 Management Objects

List of management objects supported by console and Telnet interfaces :

<u>Management Objects</u>	<u>Console</u>	<u>Telnet</u>	<u>Web</u>	<u>SNMP</u>
Boot diagnostics	Yes	-	-	-
Login check	Yes	Yes	Yes	-
Port configuration	Yes	Yes	Yes	-
Trunk configuration (& LACP)	Yes	Yes	Yes	-
VLAN configuration	Yes	Yes	Yes	-
QoS Priority configuration	Yes	Yes	Yes	-
MAC address aging setting	Yes	Yes	Yes	-
Broadcast storm filtering setting	Yes	Yes	Yes	-
Max. bridge transmit delay bound	Yes	Yes	Yes	-
Low queue delay bound setting	Yes	Yes	Yes	-
Low queue delay time setting	Yes	Yes	Yes	-
Port security setting	Yes	Yes	Yes	Yes
Collision retry forever setting	Yes	Yes	Yes	-
Port Sniffer (Mirroring) setting	Yes	Yes	Yes	-
IP configuration (TCP/IP)	Yes	Yes	Yes	-
Username, password change	Yes	Yes	Yes	-
SNMP community string settings	Yes	Yes	Yes	-
SNMP device information settings	Yes	Yes	Yes	-
Trap manager configuration	Yes	Yes	Yes	-
STP configuration	Yes	Yes	Yes	-
Static Mac address configuration	Yes	Yes	Yes	Yes
Filter Mac address configuration	Yes	Yes	Yes	-
GVRP setting	Yes	Yes	Yes	-
IGMP setting	Yes	Yes	Yes	-
802.1X configuration	Yes	Yes	Yes	-
System firmware update (TFTP)	Yes	Yes	Yes	-
System firmware update (1K modem)	Yes	-	-	-
Default configuration file download	Yes	Yes	Yes	-
Current configuration backup (TFTP)	Yes	Yes	Yes	-
Reboot switch with default settings	Yes	Yes	Yes	-
Reboot switch with current settings	Yes	Yes	Yes	-

<u>Management Objects</u>	<u>Console</u>	<u>Telnet</u>	<u>Web</u>	<u>SNMP</u>
Port state - enable/disable	Yes	Yes	Yes	Yes
Port status - link, speed	Yes	Yes	Yes	Yes
Port static counters	Yes	Yes	Yes	Yes
Device Mac address information	Yes	Yes	Yes	Yes
System firmware version information	Yes	Yes	Yes	-
System hardware version information	Yes	Yes	Yes	-
System default configuration version	Yes	Yes	Yes	-
G1, G2 module information	Yes	Yes	Yes	Yes
F23, F24 module information	Yes	Yes	Yes	Yes
Cooling Fan1 Fan2 status	Yes	Yes	Yes	Yes
LACP status	Yes	Yes	Yes	-
IGMP snooping information	-	-	Yes	-
Stacking configuration	-	-	Yes	-
Stacking switches monitoring	-	-	Yes	-
RFC 1213 MIB-2 objects	-	-	-	Yes
RFC 1493 Bridge MIB	-	-	-	Yes
RFC 1271 RMON MIB (group 1,2,3,9)	-	-	-	Yes

1.4.2 SNMP Traps

Trap Events

The table below lists the events the device will generate SNMP traps.

Generic: RFC1157 generic, Specific: EnterpriseSpecific

Type	Trap	Event
Generic	Cold Start	Device bootup
Generic	Authentication	SNMP authentication failure
Generic	Port link change	Port link down
Generic	Port link change	Port link recovery
Specific	Fan1 failure	Cooling Fan1 failure warning
Specific	Fan1 failure	Cooling Fan1 failure recovery
Specific	Fan2 failure	Cooling Fan2 failure warning
Specific	Fan2 failure	Cooling Fan2 failure recovery

1.5 Function Descriptions

1.5.1 LACP Trunking Function

The switch provides a trunking function, which is compliant with 802.3ad standard. 802.3ad is a specification from IEEE that allows us to bundle several physical port links together to form one logical port, called a trunk between two devices. It supports Link Aggregation Control Protocol (LACP).

IEEE 802.3ad trunking also allows redundant connections between devices to be combined for more aggregate bandwidth between devices supporting LACP.

The LACP provides a standardized means for exchanging information between two link partners on a link to allow their Link Aggregation Control instances to reach agreement on the identity of the Link Aggregation Group to which the link belongs, move the link to that Link Aggregation Group, and enable its transmission and reception functions in an orderly manner.

The switch can support up to seven **trunk groups**, or called trunk ports or trunks. Each group is a logic port and can have up to 4 physical port members. A physical port can only belong to one trunk group. Each trunk group can be set LACP disabled or enabled. The operations are:

LACP disabled

If one trunk group is LACP disabled, it becomes a local static trunk and all member ports are forced to be work ports. The link aggregation is formed and there is no LACP negotiation taking place. Maximal four member ports are allowed.

LACP enabled

If one trunk group is LACP enabled, it is called LACP static trunk. Link aggregation is formed through LACP negotiation between link partners. Up to four ports can be selected as member ports for each trunk group. However, the max. two ports, called work ports can be aggregated at the

same time. Those member ports which are not work ports are standby to become work port if any current work port fails to operate. This transition takes about 30 seconds. Each member port can be set LACP Passive or LACP active as described below:

LACP Passive : The port does not initiate the LACP negotiation, but it does understand the LACP packet. It will reply to the received LACP packet to eventually form the link aggregation if its link partner is requesting to do so (in active state).

LACP Active : The port is willing to form an aggregate link, and initiate the negotiation. The link aggregate will be formed if its link partner is running in LACP active or passive mode.

There are only three valid combinations to run the LACP link aggregate as follows:

- disabled to disabled state (forced link aggregate without LACP)
- active to active state
- active to passive state

Rules of trunking

1. Up to seven trunk groups (trunk ports) can be created.
2. Each trunk group can be composed of up to 4 member ports.
3. The member port can be one of Port 1 ~ Port 24 and G1 - G2 port.
4. One switched port only can belong to one trunk group.
5. If VLAN group exist, all members of one static trunk group **must** be in same VLAN group.
6. LACP operation requires member ports in full-duplex mode.
7. In a static trunk group (LACP disabled), four work ports are aggregated at the same time.
8. In an LACP trunk group, maximal two work ports can be aggregated at the same time.

1.5.2 IP Multicast Function

Internet Protocol (IP) multicast is a bandwidth-conserving technology that reduces traffic by simultaneously delivering a single stream of information to thousands of corporate recipients and homes. Applications that take advantage of multicast include video conference, corporate communications, distance learning, and distribution of software, stock quotes, and news.

IP Multicast delivers source traffic to multiple receivers without adding any additional burden on the source or the receivers while using the least network bandwidth of any competing technology. Multicast packets are replicated in the network by the devices supporting multicast protocols resulting in the most efficient delivery of data to multiple receivers possible.

Multicast is based on the concept of a group. An arbitrary group of receivers expresses an interest in receiving a particular data stream. This group does not have any physical or geographical boundaries - the hosts can be located anywhere on the Internet. Hosts that are interested in receiving data flowing to a particular group must join the group using IGMP. Hosts must be a member of the group to receive the data stream.

IP Multicast address

IP Multicast addresses specify an arbitrary group of IP hosts that have joined the group and want to receive traffic sent to this group. IP multicast addresses range from 224.0.0.0 through 239.255.255.255. This address range is only for the group address or destination address of IP multicast traffic. The source address for multicast datagrams is always the unicast source address.

IGMP

Internet Group Management Protocol (IGMP) is used to dynamically register individual hosts in a multicast group on a particular LAN. Hosts identify group memberships by sending IGMP messages to their local multicast router. Under IGMP, routers listen to IGMP messages and periodically send out queries to discover which groups are active or inactive on a particular subnet.

RFC 2236 defines the specification for IGMP Version 2. There are four types of IGMP messages:

- Membership query
- IGMP Version 1 membership report
- IGMP Version 2 membership report
- Leave group

Hosts send out IGMP membership reports corresponding to a particular multicast group to indicate that they are interested in joining that group. The router periodically sends out an IGMP membership query to verify that at least one host on the subnet is still interested in receiving traffic directed to that group. When there is no reply to three consecutive IGMP membership queries, the router times out the group and stops forwarding traffic directed toward that group.

With leave group message, the hosts can actively communicate to the local multicast router their intention to leave the group. The router then sends out a group-specific query and determines whether there are any remaining hosts interested in receiving the traffic. If there are no replies, the router times out the group and stops forwarding the traffic.

IGMP Snooping

IGMP snooping requires the LAN switch to examine, or snoop, some Layer 3 information in the IGMP packets sent between the hosts and the router. When the switch hears the IGMP host report from a host for a particular multicast group, the switch adds the host's port number to the associated multicast table entry. When the switch hears the IGMP leave group message from a host, it removes the host's port from the table entry.

Multicast Forwarding

In multicast routing, the source is sending traffic to an arbitrary group of hosts represented by a multicast group address. The multicast router must determine which direction is upstream (toward the source) and which direction (or directions) is downstream. If there are multiple downstream paths, the router replicates the packet and forwards the traffic down the appropriate downstream paths - which is not necessarily all paths.

The switch can support IP multicast if IGMP protocol is enabled. IGMP snooping function and status is also provided. Each IP multicast address is associated one Vlan ID and its member ports. The information is available from management interfaces.

1.5.3 MAC Address Filtering Function

MAC address filtering allows the switch to drop unwanted traffic. Incoming traffic is filtered based on the destination MAC addresses (DAs). The unwanted destination addresses are called filter MAC addresses.

The switch provides management function that allows LAN administrator to maintain the filter MAC address table.

1.5.4 Static MAC Address

The switch provides Static MAC Address setup function. The static MAC addresses are the MAC addresses which are setup by LAN administrators and are not learned by the switch automatically.

The static addresses are stored and referred in switch MAC address table permanently regardless of whether the MAC addresses are physically disconnected to the switch.

Applying this function with port security function allows LAN administrator to build a protection mechanism that let switch only serves granted devices.

Static MAC address related settings:

Mac Address : Static Ethernet MAC address (12 digits)

Port num : The port number where the MAC address is located

Vlan ID : The associated Vlan ID to the address, if 802.1Q VLAN is enabled.

1.5.5 Port Security

A port in security mode does not learn any source MAC address (SA). Only the incoming packets with SA existing in the switch static MAC address table can be forwarded normally. Otherwise, the packets are dropped. This features provides a protection mechanism to restrict the devices link to the switch port. Only devices with valid MAC addresses can be served by the switch.

1.5.6 VLAN Function

Virtual LANs (VLANs) can be viewed as a group of devices on different physical LAN segments which can communicate with each other as if they were all on the same physical LAN segment. It can create a network that is independent of physical location and group users into logical workgroups. The benefits are:

- Confine broadcast traffic and Increased performance
- Improved manageability
- Network tuning and simplification of software configurations
- Physical topology independence
- Increased security options

The switch supports port-based, 802.1Q (Tag-based) and protocol-based VLAN. In the default configuration, VLAN function is disabled.

1.5.6.1 Port-based VLAN

Up to 26 VLAN groups can be created. Each group has its own port members. The member ports are selected among the physical ports on the switch. Packets can go among only members in the same VLAN group.

Required configurations:

- Maintain (Create/delete/modify) VLAN groups
- Manage the port members of each VLAN group

Note:

1. The ports which are not belonging to any group are treated as belonging to another single VLAN.
2. A trunk group is treated as a physical port.
3. VLAN-tagging is ignored in port-based VLAN mode.

1.5.6.2 IEEE 802.1Q VLAN (Tag-based VLAN)

Tag-based VLAN is an IEEE 802.1Q specification standard. Therefore, it is possible to create a VLAN across devices from different vendors. IEEE 802.1Q VLAN uses a technique to insert a tag into the Ethernet frames. Tag contains a VLAN Identifier (VID) that indicates the VLAN numbers.

The switch can classify each received packet as belonging to one and only one VLAN. If the received packet is VLAN-tagged, the packet is classified as belonging to the VLAN specified in the VLAN tag header. If the received packet is untagged, it is classified as belonging to the default VLAN configured for the ingress port.

Required configurations:

- Enable or disable GVRP support
- VLAN information including VID (2-4094) and name
- Tagged member ports of each VLAN
- Outgoing tag mode for each member port
 - Tag** - outgoing frames with VLAN-tagged
 - Untag** - outgoing frames without VLAN-tagged
- PVID (Port VID, 1-255 for untagged incoming frames) for each port
- Ingress Rule 1 setting for each port : forward only packets with VID matching configured PVID
- Ingress Rule 2 setting for each port : drop untagged frames

PVID : this feature is useful to accommodate the devices which do not support tagging to participate in the VLAN.

GVRP - GARP [Generic Attribute Registration Protocol] VLAN Registration Protocol : GVRP allows automatic VLAN configuration between the switch and nodes. If the switch is connected to a device with GVRP enabled, you can send a GVRP request using the VID of a VLAN defined on the switch, the switch will automatically add that device to the existing VLAN. (GVRP - 802.1Q compliant, GARP - 802.1P compliant)

1.5.6.3 Protocol-based VLAN

In order for an end station to send packets to different VLANs, it itself has to be either capable of tagging packets it sends with VLAN tags or attached to a VLAN-aware bridge that is capable of classifying and tagging the packet with different VLAN ID based on not only default PVID but also other information about the packet, such as the protocol. The switch can support 802.1v compliant protocol-based VLAN classification by means of both built-in knowledge of layer 2 packet formats used by selected popular protocols, such as Novell IPX and AppleTalk's EtherTalk, and others. Required configuration:

- Protocol setting for each VLAN group defined in 802.1Q VLAN mode
- If more than two VLAN groups are configured with same protocol value, make sure the member ports of those groups are not overlapping.

Any incoming untagged packet is checked and classified according the Protocol vs. VLAN mapping settings. If an associated VLAN group is found, the packet is classified and is inserted with VID tag of the group VLAN ID instead of input port PVID.

1.5.7 Spanning Tree Protocol

Spanning-Tree Protocol (STP) is a link management protocol that provides path redundancy while preventing undesirable loops in the network. For an Ethernet network to function properly, only one active path must exist between two stations. Multiple active paths between stations cause loops in the network. If a loop exists in the network, you might receive duplicate messages. When loops occur, some switches see stations on both sides of the switch. This condition confuses the forwarding algorithm and allows duplicate frames to be forwarded.

To provide path redundancy, Spanning-Tree Protocol defines a tree that spans all switches in an extended network. Spanning-Tree Protocol forces certain redundant data paths into a standby (blocked) state. If one network segment in the Spanning-Tree Protocol becomes unreachable, or if Spanning-Tree Protocol costs change, the spanning-tree algorithm

re-configures the spanning-tree topology and reestablishes the link by activating the standby path.

Spanning-Tree Protocol operation is transparent to end stations, which are unaware whether they are connected to a single LAN segment or a switched LAN of multiple segments.

STP related parameters

Priority : A value to identify the root bridge. The bridge with the lowest value has the highest priority and is selected as the root.

MAC Address : The MAC address of the switch as a unique identifier to the network.

Max Age : The number of seconds a bridge waits without receiving Spanning Tree protocol configuration messages before attempting a reconfiguration. Maximum Age Timer measures the age of the received protocol information recorded for a port and ensures that this information is discarded when its age limit exceeds the value of the maximum age parameter recorded by the switch. The time-out value for this timer is the maximum age parameter of the switches.

Hello Time : The number of seconds between the transmission of Spanning Tree protocol configuration messages. It determines how often the switch broadcasts its hello message to other switches.

Forward Delay Time : The number of seconds a port waits before changing from its Spanning Tree Protocol learning and listening states to the forwarding state. Forward Delay Timer Monitors the time spent by a port in the learning and listening states. The time-out value is the forward delay parameter of

Spanning tree port states

Listening : Switches send messages to one another to establish the network topology and the optimal paths to the different segments of the network. Other data is not transmitted.

Blocking : The switch enters the Blocking State if a path with higher priority is found to exist during the Listening State. Normal data is not transmitted.

Learning : The switch enters the Learning State if no path with a higher priority is found during the Listening State. Learned entries are entered in the Unicast Destination Forwarding Table. Normal data is not transmitted.

Forwarding : The switch enters the Forwarding State after having been in the Learning State for a predefined time period. Normal data is transmitted.

Per port control settings

PathCost : Specifies the path cost for each port. The Spanning-Tree Protocol uses port path costs to determine which port to select as a forwarding port. You should assign lower numbers to ports attached to faster media (such as full duplex), and higher numbers to ports attached to slower media. The possible range is 1 to 65535. The recommended path cost is 1000 divided by LAN speed in megabits per second.

Priority : Specify STP port priority for each port. The port (physical or logical) with the lowest priority value has the highest priority and forwards the spanning-tree frames. The possible priority range is 0 through 255 (decimal). The default is 128. If all ports have the same priority value, the lowest port number forwards the spanning-tree frames.

1.5.8 Port Sniffer Function

Port sniffer function is a method to duplicate all traffic occurred on the specified monitored ports to the designated sniffer port. The traffic can be configured for incoming packets only or outgoing packets only or both. The control settings are:

Sniffer Mode : Specify the traffic type for monitoring

Options - Disable, Rx=incoming, Tx=outgoing, Both=Rx&Tx

Sniffer Port : Specify the port where performs monitoring

Monitored Port : Select the ports whose traffic will be duplicated to the monitoring port. Press Space key for selection from the port member list.

1.5.9 QoS Priority Function

This switch supports two priority levels, high and low, and provides two priority functions:

1. Port-based Priority (Static priority)
2. 802.1p Priority (VLAN tagged priority)

Priority Classification Methods

Static priority is called port-based priority. The priority level of a receiving packet is determined by the configured priority of the input port where the packet is received and the content of the packet is ignored. Each port must be pre-configured with a priority level for incoming frames or disabled setting.

802.1p Priority is a content-based priority method. If the receiving packet is an 802.1Q VLAN tagged packet, the switch will check the 3-bit User Priority value in TCI (Tag Control Information) field of packet tag data. By this value, the packet is classified as high priority or low priority according to 802.1p priority configuration. The map of priority values vs. priority levels must be pre-configured.

The switch uses the following rules:

1. Applies Static Priority method first for tagged or untagged packets.
2. If port static priority is disabled, applies 802.1p Priority method.
3. Untagged packets are treated as low priority.

Outgoing Service Policy

The switch provides two options for outgoing service policy for high priority packets and low priority packets.

1. High priority always first
2. Round robin method with specified [High : Low] ratio setting

This policy configuration can be set via the management interface.

1.5.10 802.1X Port-Based Network Access Control

For some IEEE 802 LAN environments, it is desirable to restrict access to the services offered by the LAN to those users and devices that are permitted to make use of those services. IEEE 802.1X Port-based network access control function provide a means of authenticating and authorizing devices attached to a LAN port that has point-to-point connection characteristics, and of preventing access to that port in cases in which the authentication and authorization process fails. The 802.1X standard relies on the client to provide credentials in order to gain access to the network. The credentials are not based on a hardware address. Instead, they can be either a username/password combination or a certificate. The credentials are not verified by the switch but are sent to a Remote Authentication Dial-In User Service (RADIUS) server, which maintains a database of authentication information. 802.1X consists of three components for authentication exchange, which are as follows:

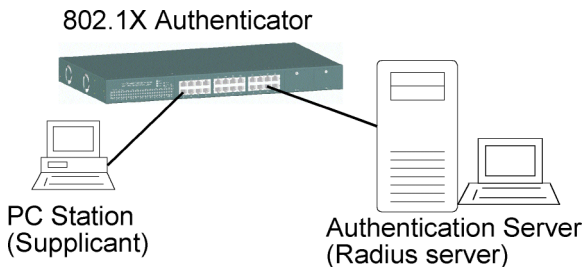

- **An 802.1X authenticator:** This is the port on the switch that has services to offer to an end device, provided the device supplies the proper credentials.
- **An 802.1X supplicant:** This is the end device; for example, a PC that connects to a switch that is requesting to use the services (port) of the device. The 802.1X supplicant must be able to respond to communicate.
- **An 802.1X authentication server:** This is a RADIUS server that examines the credentials provided to the authenticator from the supplicant and provides the authentication service. The authentication server is responsible for letting the authenticator know if services should be granted.

The 802.1X authenticator operates as a go-between with the supplicant and the authentication server to provide services to the network. When a switch is configured as an authenticator, the ports of the switch must then be configured for authorization. In an authenticator-initiated port authorization, a client is powered up or plugs into the port, and the authenticator port sends an Extensible Authentication Protocol (EAP) PDU to the supplicant requesting the identification of the supplicant. At this point in the process, the port on the switch is connected from a physical standpoint; however, the 802.1X process has not authorized the port and no frames are passed from the port on the supplicant into the switching engine. If the PC attached to the switch did not understand the EAP PDU that it was receiving from the switch, it would not be able to send an ID and the port would remain unauthorized. In this state, the port would never pass any user traffic and would be as good as disabled. If the client PC is running the 802.1X EAP, it would respond to the request with its configured ID. (This could be a username/password combination or a certificate.)

After the switch, the authenticator receives the ID from the PC (the supplicant). The switch then passes the ID information to an authentication server (RADIUS server) that can verify the identification information. The RADIUS server responds to the switch with either a success or failure message. If the response is a success, the port will be authorized and user traffic will be allowed to pass through the port like any switch port connected to an access device. If the response is a failure, the port will remain unauthorized and, therefore, unused. If there is no response from the server, the port will also remain unauthorized and will not pass any traffic.

The following configuration settings are required in the switch to make 802.1X function work:

Enable 802.1X protocol

Radius client configuration -

Radius server IP : IP address of the Radius server

Shared key : an encryption key for use during authentication sessions with the specified Radius server. It must match the key used on the Radius server.

NAS identifier : identifier for this Radius client

Server port : the UDP destination port for authentication requests to the specified Radius server

Accounting port : the UDP destination port for accounting requests to the specified Radius server

Per-port 802.1X mode setting:

Auto (Au) - The port is set to the Authorized or Unauthorized state in accordance with the outcome of an authentication exchange between the Supplicant and the Authentication Server.

Forced Authorized (Fa) - The port is forced to be in authorized state.

Forced Unauthorized (Fu) - The port is forced to be in unauthorized state.

None (No) - The port is not necessary authorized.

Misc. configuration:

quietPeriod - the period during which the port does not try to acquire a supplicant

txPeriod - the period the port waits to retransmit the NEXT EAPOL PDU during an authentication session

suppTimeout - the period of time the switch waits for a supplicant response to an EAP request

serverTimeout - the period of time the switch waits for a server response to an authentication request

reAuthMax - the number of authentication attempts that must time-out before authentication fails and the authentication session ends.

reAuthPeriod - the period of time after which the connected radius clients must be re-authenticated

2. Installation and Management

2.1 Panel Description

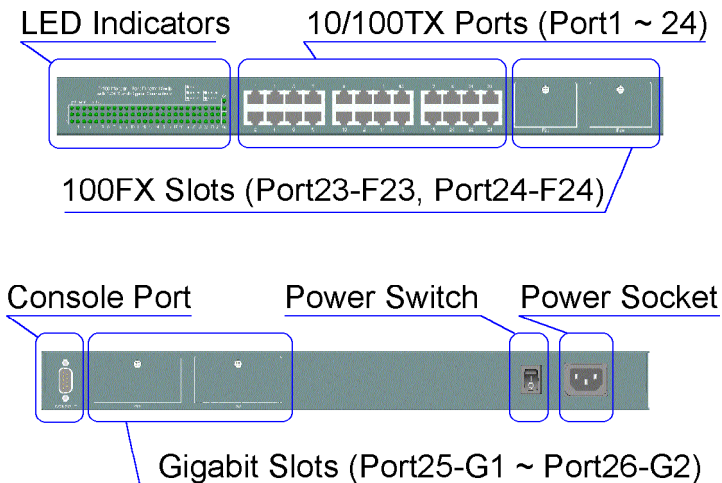

2.2 AC Power Supply

One AC power cord which meets the specification of your country of origin was supplied with the switch unit. Before installing AC power cord to the switch, make sure the AC power switch is in OFF position and the AC power to the power cord is turned off. The switch supports wide range of AC power input specifications as follows:

Power Rating :	100 ~ 240VAC, 50/60Hz, 50W
Voltage Range :	90 ~ 260VAC
Frequency :	47 ~ 440 Hz
Inrush Current :	24A@230V
Minimal Consumption :	17W
Maximal Consumption :	26W

2.3 Network Switched Ports

The switch provides three types of switched ports as follows:

<u>Port Number</u>	<u>Label</u>	<u>Specifications</u>	<u>Port Type</u>	<u>Modules</u>
Port 1 - 22	1 - 22	Fixed RJ-45	10/100TX	No
Port 23 - 24	23 - 24	Fixed RJ-45	10/100TX	No
	F23 - F24	Module slot	100FX	Optional
Port 25-26	G1 - G2	Module slot	Gigabit	Optional

2.3.1 10/100TX Ports

The 10/100TX ports supports the following connection types and distances:

<u>Speed</u>	<u>Compliance</u>	<u>Cables</u>	<u>Distance</u>
10Mbps	IEEE 802.3 10BASE-T	Cat. 3, 4, 5, 5e	100 meters
100Mbps	IEEE 802.3u 100BASE-TX	Cat. 5, 5e	100 meters

The ports can be configured to one of the following operating modes:

Auto mode : The port is auto-negotiation enabled and uses the speed and duplex settings as the highest port capability for negotiation with its auto-negotiation capable link partner.

Nway_Forced mode : The port is auto-negotiation enabled and uses the speed and duplex settings as the only port capability for negotiation with its auto-negotiation capable link partner.

Forced mode : The port is auto-negotiation disabled and uses the speed and duplex settings as the connection configuration.

2.3.2 100FX Modules

Port 23 and Port 24 also provide optional fiber connectivity. The following installation rules should be applied:

100FX Module Installation

F23 Slot

None
Installed
None
Installed

F24 Slot

None
None
Installed
Installed

Working Connectors

Port 23

P23 RJ-45
F23 module
P23 RJ-45
F23 module

Port 24

P24 RJ-45
P24 RJ-45 can not be used
F24 module
F24 module

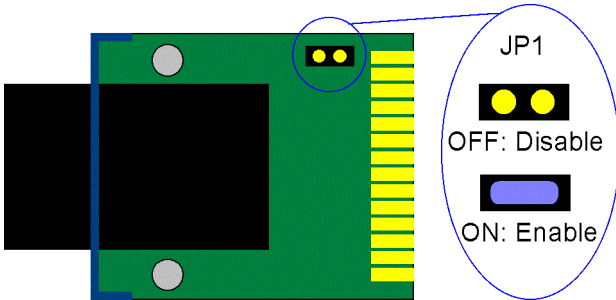

This figure illustrates an example of 100FX module. Every module has one jumper JP1 as shown. JP1 can be used to disable the module even the module is installed in the switch unit.

JP1 setting

ON - Short the jumper to enable the module

ON - Open the jumper to enable the module

The following 100FX modules are supported by F23 and F24 slots:

<u>Part Number</u>	<u>Connector</u>	<u>Cable</u>	<u>Distance</u>
2260-FMT	Duplex ST	MMF*	2 km
2260-FMC	Duplex SC	MMF	2 km
2260-FJM	MT-RJ	MMF	2 km
2260-FVM	VF-45	MMF	2 km
2260-FSA2	Duplex SC	SMF*	20 km
2260-FSL2	Duplex SC	SMF	2-30 km

Note: * MMF - Multimode Fiber cable 50/125, 62.5/125
* SMF - Single Mode Fiber cable 8.7/125, 9/125, 10/125

Specifications

IEEE 802.3u 100BASE-FX compliant, Fixed 100Mbps, Fixed Full duplex

Optical Specifications

<u>Part Number</u>	<u>Wavelength</u>	<u>Output Power</u>	<u>Input Optical Power</u>
2260-FMT	1310nm	-19 ~ -14dBm	-31dBm min. -14dBm max.
2260-FMC	1310nm	-19 ~ -14dBm	-31dBm min. -14dBm max.
2260-FJM	1310nm	-20 ~ -14dBm	-31dBm min. -14dBm max.
2260-FVM	1310nm	-20.5 ~ -15dBm	-33dBm typ. sensitivity
2260-FSA2	1310nm	-18 ~ -7dBm	-32dBm max. sensitivity
2260-FSL2	1310nm	-15 ~ -8dBm	-34dBm max. sensitivity

Installation steps:

1. Turn the power to the switch off.
2. Set JP1.
3. Insert the 100FX modules and screw the modules securely.
4. Turn the power to the switch on.

F23, F24 slots with 100FX modules

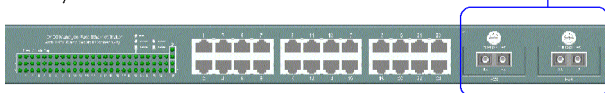

2.3.3 Gigabit Ports and Modules

Port 25 and Port 26, labeled G1 and G2 respectively, support the following Gigabit modules:

<u>Part Number</u>	<u>Connector</u>	<u>Cable</u>	<u>Distance</u>
2260-GT	RJ-45	Cat.5e	100m
2260-SXC	Duplex SC	MMF 62.5/125	220m
		MMF 50/125	500m
2260-SXL	Duplex LC	MMF 62.5/125	220m
		MMF 50/125	500m
2260-LXC	Duplex SC	MMF 62.5/125	550m
		MMF 50/125	550m
		SMF 9/125	10km
2260-LXC40	Duplex SC	SMF 9/125	10~50 km

2260-SFP Depends on the installed pluggable fiber transceiver

Note: 2260-SFP module provides an SFP (Small Form factor Pluggable) cage which can accommodate different types of SFP fiber transceivers. The transceiver is not included in the module package and should be purchased separately.

The following figures illustrate the outline of the Gigabit port modules:

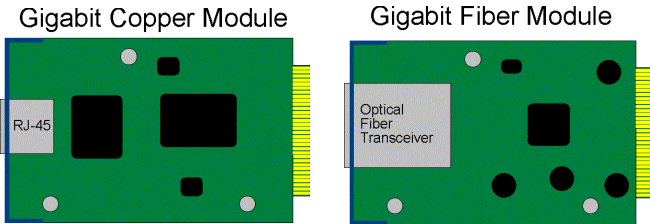

Specifications

<u>Part Number</u>	<u>Compliance</u>	<u>Speed</u>	<u>Duplex</u>
2260-GT	IEEE 802.3ab 1000BASE-T	1000Mbps	Half / Full
	IEEE 802.3u 100BASE-TX	100Mbps	Half / Full
	IEEE 802.3 10BASE-T	10Mbps	Half / Full
	Auto-negotiation function MDI-X RJ45		
2260-SXC	IEEE 802.3z 1000BASE-SX	1000Mbps	Full
2260-SXL	IEEE 802.3z 1000BASE-SX	1000Mbps	Full
2260-LXC	IEEE 802.3z 1000BASE-LX	1000Mbps	Full
2260-LXC40	IEEE 802.3z 1000BASE-LX	1000Mbps	Full
2260-SFP	IEEE 802.3z 1000BASE-X	1000Mbps	Full
	(depends on the SFP transceiver installed)		

Optical Specifications

<u>Part Number</u>	<u>Wavelength</u>	<u>Output Power</u>	<u>Input Optical Power</u>
2260-SXC	850nm	-9.5 ~ -4dBm	-17 (sensitivity) ~ 0 dBm
2260-SXL	850nm	-9.5 ~ -4dBm	-17 (sensitivity) ~ 0 dBm
2260-LXC	1310nm	-11 ~ -3dBm	-22 (sensitivity) ~ -3 dBm
2260-LXC40	1550nm DFB	-5 ~ 0dBm	-24 (sensitivity) ~ -3 dBm

The following SFP transceiver have been tested for the compatibility with 2260-SFP module for 1000BASE-X compliance:

<u>Part Number</u>	<u>Wavelength</u>	<u>Specifications</u>
Agilent HFBR-5710L_LP	850nm VCSEL	MM LC-Duplex
E2O EM125-LP3TA	850nm VCSEL	MM LC-Duplex
E2O EM125-MP3TA	850nm VCSEL	MM MT-RJ
Optoway SPM-7100	850nm VCSEL	MM LC-Duplex
Optoway SPS-7110	1310nm	LC-Duplex SMF 10km

More SFP solutions are continuously supported. For latest available SFP transceiver list, consult your dealer for more information.

Giga Port Module Installation steps:

1. Turn the power to the switch off.
2. Insert the Gigabit modules and screw the modules securely.
3. Turn the power to the switch on.

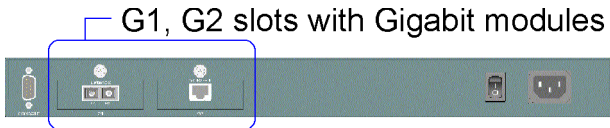

2.4 Rack Mounting

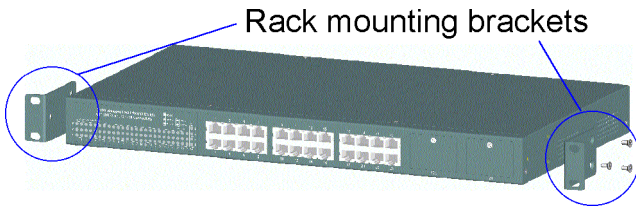

Two 19-inch rack mounting brackets are supplied with the switch for 19-inch rack mounting.

The steps to mount the switch onto a 19-inch rack are:

1. Turn the power to the switch off.
2. Install two brackets with supplied screws onto the switch as shown in above figure:
2. Mount the switch onto 19-inch rack with rack screws securely.
3. Turn the power to the switch on.

2.5 LED Indicators

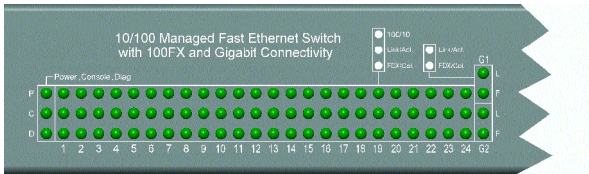

LED Name	State	Interpretation
System LEDs		
P(Power)	On	Power is supplied to the unit.
	Off	No power is supplied to the unit.
C(Console)	On	Tx activities
	Off	No Tx or Rx
D(Diag)	Blink	Diagnostic and initialization in process
	On	Diagnostic and initialization completed
Port 1 ~ Port 24 LEDs		
100/10	On	Port speed is 100Mbps.
	Off	Port speed is 10Mbps.
Link/Act.	On	Port link up
	Off	Port link down
	Blink	Port Tx/Rx activities
FDX/Col.	On	Port is in full duplex.
	Off	Port is in half duplex.
	Blink	Collisions
Port 25 (G1), Port 26 (G2) LEDs		
Link/Act.	On	Port link up
	Off	Port link down
	Blink	Port Tx/Rx activities
FDX/Col.	On	Port is in full duplex.
	Off	Port is in half duplex.
	Blink	Collisions

2.6 Cooling Fans

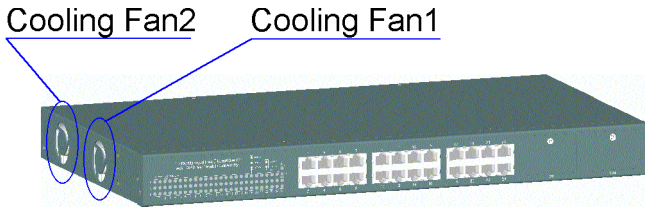

The switch is equipped with two cooling fans. Both fans are featured with failure detection function. When the fan operation speed is below the specification, it is detected as a failure. The fan status can be monitored via management functions. One fan failure trap is also issued when fan failure event occurs.

Important :

Do not operate the switch unit when a fan failure is detected. Without normal operation of the cooling fans, the switch unit might not operate properly or even might be damaged due to not enough ventilation. Return the defective unit to the dealer where it was purchased.

2.7 Management Setup

The managed switch is featured with management functions and can be managed by using the following methods:

- Direct console connection over an RS-232 cable
- Telnet software over TCP/IP network
- SNMP manager software over TCP/IP network
- Web browser software from Internet or Intranet over TCP/IP network
- SNMP trap hosts from Internet or Intranet over TCP/IP network

The following figure illustrates a management model diagram:

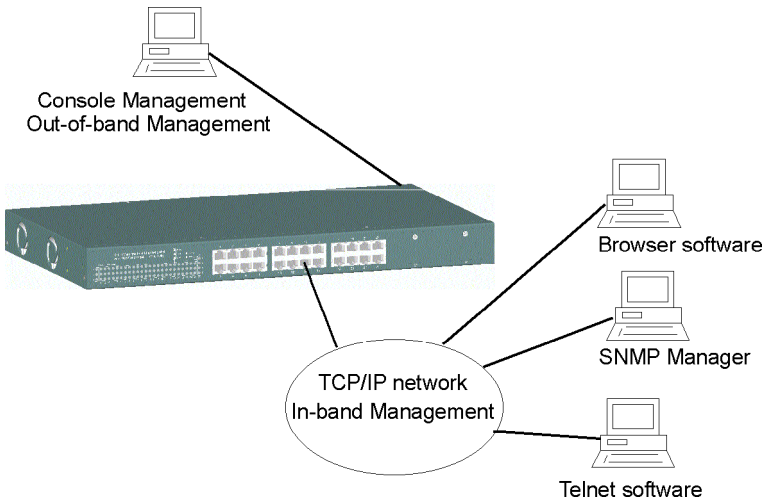

2.7.1 Setup for Out-of-band (Console) Management

Before doing any in-band management, it is necessary to perform console operation for configuring IP and SNMP related settings for the first time the switch is received for installation. Any PC running Windows 95/98/ or NT can be used as a console via COM port. Windows Hyper Terminal program is an ideal and the most popular software for such console terminal operations.

To setup console operation, the steps are:

1. Find a proper RS-232 cable for the connection to a console terminal.
If you are using PC as a terminal, make sure the cable pin assignments comply to the following requirement.

Console port			9-pin PC COM port
Pin2	RXD	-----	3
3	TXD	-----	2
4	DTR	-----	6
5	GND	-----	5
6	DSR	-----	4

2. Connect one end to the console port and connect the other end to the PC COM port.
3. Configure your PC COM port setting to match the RS-232 settings of the console port and start your terminal software.

Factory default settings of the Console port

Baud rate : 9600, N, 8, 1, 0

Flow control : disabled

4. Turn the switch unit power on.
5. Press <Enter> key several times in your terminal software until a login prompt comes up. It means the connection is proper.

The console port does not support modem connection. Refer to Chapter 3 for more information about Console management.

2.7.2 Setup for In-band Management

To perform an in-band management, it is necessary to connect the system to your TCP/IP network. The steps are:

1. Configure IP and SNMP related settings to the device using direct console management when you receive it first time for the installation.
2. Find a proper straight-through Category 5 UTP cable (maximal length 100 meters) for the connection.
3. Connect one end of the UTP cable to the UTP port of the media converter and connect the other end to a network device, such as a switching hub, in your TCP/IP network.
4. Start your in-band management operations. For different management methods, refer to:
 - Chapter 3 for Console and Telnet management
 - Chapter 4 for SNMP management
 - Chapter 5 for Web management

2.7.3 Quick Guide to Configure Switch IP Address

This section provides a quick instruction to configure a new IP address via Console port for the switch received for the first time. The steps are:

1. Set up console connection as described in section 2.7.1.
2. Login with default username= admin and password=123.
3. Menu selections to enter IP configuration as follows:

Main Menu

-> Switch Static Configuration

-> Administration Configuration

-> IP Configuration

3. Console and Telnet Operation

This chapter describes the detailed console operation. It can be applied to either out-of-band console management or in-band Telnet management. Refer to Chapter 2 for installation details.

Cold Start

When the power to the switch is turned on, the device start initialization and self-test process. The self-test messages are displayed as follows if a console connection is established successfully.:

Power-on Self-test Console message

```
-----  
$$$ Switch LOADER Checksum O.K !!!  
$$$ Press any key to start Xmodem receiver:  
$$$ Switch IMAGE Checksum ..... O.K !!!  
$$$ Loading IMAGE .....  
$$$ Switch Power On Self Test...  
$$$ CPU(arm7) Sdram Test Start..  
++ Memory Test (Long) .... O.K !!!  
++ Memory Test (Short) ... O.K !!!  
++ Memory Test (Byte) .... O.K !!!  
$$$ CPU(arm7) Sdram Test O.K !!!  
$$$ Switch Register R/W Test ...O.K !!!  
$$$ Phy Register R/W Test ...O.K !!!  
$$$ Embedded Sram Built In Self Test ...O.K !!!  
$$$ Switch Data Area Checksum ...O.K !!!  
$$$ Detect Module Card... O.K !!!  
$$$ Switch Engine Initialize...O.K !!!  
$$$ Trunk Initialize...O.K !!!  
$$$ Port Initialize...O.K !!!  
$$$ BwCtrl Initialize...O.K !!!  
$$$ Forwarding Initialize...O.K !!!  
$$$ Vlan Initialize...O.K !!!  
-----
```

Both console management and Telnet management are same in operation starting from login prompt.

Direct Console Management

When you can see the self-test messages shown on screen properly, you can press <Enter> key to start console login operation. Go to **Login Prompt** section in next page directly.

Telnet Management

Use Telnet software to perform the management operation. The most convenient solution is using the built-in Telnet function in a Windows 95/98/ or NT PC. Enter into DOS window and invoke Telnet command :

```
>tel net xxx. xxx. xxx. xxx
```

to connect to the device. The specified xxx.xxx.xxx.xxx is the IP address of the device. Factory default IP address is 192.168.0.2.

A welcome message and login prompt are displayed if the connection is established properly.

Login Prompt

The following figure illustrates the login screen:

```
-----  
                User Interface  
            Managed 24 + 2G Swi tch  
  
            l o g i n : x x x x  
            p a s s w o r d : x x x x  
-----
```

Username : admin

Factory default Password : 123

For security reason, the device supports a function to change the password in setup menu. It is recommended to change the default password immediately after a successful login.

3.1 Main Menu

When login successfully, the main menu is shown as follows:

```
-----  
                M a i n  M e n u  
  
    S w i t c h  S t a t i c  C o n f i g u r a t i o n  
    P r o t o c o l  R e l a t e d  C o n f i g u r a t i o n  
    S t a t u s  a n d  C o u n t e r s  
    R e b o o t  S w i t c h  
    T F T P  U p d a t e  F i r m w a r e  
    L o g o u t  
  
        C o n f i g u r e  t h e  s w i t c h .  
  
    A r r o w / T A B / B K S P C  =  M o v e  I t e m   E n t e r =  S e l e c t  I t e m  
-----
```

Function description of the selected item:

Switch Static Configuration : Configure the switch related settings
Protocol Related Configuration : Configure the protocol parameters
Status and Counters : Show the status of the switch
Reboot Switch : Reboot the system or restore factory default configuration
TFTP Update Firmware : Use tftp to download firmware image
Logout : Exit the menu line program.

The following operation convention is commonly used for later configuration pages:

Action menu:

<Quit>	Exit configuration
<Edit>	Edit each configuration value
<Save>	Save all configured values
<Previous Page>	Browse previous configuration page
<Next Page>	Browse next configuration page

Control keys for action menu:

[Tab] key	Move to next item
[Backspace] key	Move to previous item
[Enter] key	Confirm selection

Control keys used for <Edit> operation:

[Tab] key	Move to next item
[Backspace] key	Move to previous item
[Space] key	Change configuration option
[Ctrl+A] key	Quit from <Edit> operation, back to action menu

3.2 Switch Static Configuration

[Switch Static Configuration] menu is shown as follows:

Managed 24+2G Switch : Switch Configuration

Port Configuration

Trunk Configuration

VLAN Configuration

Misc Configuration

Administration Configuration

Port Sniffer Configuration

Priority Configuration

MAC Address Configuration

Main Menu

Display or change port configuration

3.2.1 Port Configuration

The following page illustrates Port 1 ~ Port 8 configuration example:

Managed 24+2G Switch : Port Configuration

Port	Type	InRate	OutRate	Enable	Auto	Spd/Dpx	FlowControl	
		(100K)	(100K)				Full	Half
PORT1	100TX	0	0	Yes	AUTO	100 FULL	0n	0n
PORT2	100TX	0	0	Yes	AUTO	100 FULL	0n	0n
PORT3	100TX	0	0	Yes	AUTO	100 FULL	0n	0n
PORT4	100TX	0	0	Yes	AUTO	100 FULL	0n	0n
PORT5	100TX	0	0	Yes	AUTO	100 FULL	0n	0n
PORT6	100TX	0	0	Yes	AUTO	100 FULL	0n	0n
PORT7	100TX	0	0	Yes	AUTO	100 FULL	0n	0n
PORT8	100TX	0	0	Yes	AUTO	100 FULL	0n	0n

action-> <Quit> <Edit> <Save> <Previous Page> <Next Page>

Tab=Next Item BackSpace=Previous Item Quit=Previous Menu Enter= Select Item

Port : Port number

Display names - PORT1 - PORT24, G1 - G2

Type : Port type

Display names - 100Tx, 100FX, 1000T, 1000FX

InRate : Input (Ingress) rate control setting, 100Kbytes per unit.

Options - 0 = disable rate control, 1 ~ 1000 valid rate value

OutRate : Output (Egress) rate control setting, 100Kbytes per unit

Options - 0 = disable rate control, 1 ~ 1000 valid rate value

Enable : Port function enable / disabled control setting

Options - Yes=Enable, No=Disable

Auto : Port auto negotiation mode control setting

Options - Auto, Nway_Force, Force

Spd/Dpx : Port speed and duplex configuration control setting

Flow Control / Full : Full duplex flow control (Pause frame) setting

Options - On=Enable, Off=Disable

Flow Control / Half : Half duplex flow control (Backpressure) setting

Options - On=Enable, Off=Disable

Note:

1. Port 25 (G1 slot) and Port 26 (G2 slot) are not displayed if no module is installed in the slot.
2. Input (Ingress) Rate control function works only when the port and its link partner operate with flow control enabled.

3.3.2 Trunk Configuration

Trunk configuration example page

```
-----  
Managed 24+2G Switch : Trunk Configuration  
  
01 02 03 04 05 06 07 08 09 10 11 12 13 14 15 16 17 18 19 20 21 22 23 24 G1 G2  
1 v v v v - - - - - - - - - - - - - - - - - -  
2 - - - - v v v v - - - - - - - - - - - - - - - -  
3 - - - - - - - - - - - - - - - - - - - - - - -  
4 - - - - - - - - - - - - - - - - - - - - - - -  
5 - - - - - - - - - - - - - - - - - - - - - - -  
6 - - - - - - - - - - - - - - - - - - - - - - -  
7 - - - - - - - - - - - - - - - - - - - - - - -  
  
TRK1    STATI C  
TRK2    LACP  
TRK3    DI SABLE  
TRK4    DI SABLE  
TRK5    DI SABLE  
TRK6    DI SABLE  
TRK7    DI SABLE  
  
acti on->    <Edi t>    <Save>    <Qui t>  
-----  
Tab=Next I tem BackSpace=Previ ous I tem Qui t=Previ ous Menu Enter= Select I tem  
-----
```

Select up to four member ports for each enabled trunk group.

Trunk port mode control settings for each trunk group:

- DISABLE** The group is disabled.
- STATIC** Normal trunk
- LACP** This trunk group is LACP enabled.

Refer to Chapter 1 for description of LACP trunking function.

3.3.3 VLAN Configuration

Managed 24+2G Switch : VLAN Configuration

VLAN Configure
Create a VLAN Group
Edit/Delete a VLAN Group
Group Sorted Mode
Previous Menu

Configure the VLAN pvid and ingress.egress rules

Tab=Next Item BackSpace=Previous Item Quit=Previous Menu Enter= Select Item

3.3.3.1 VLAN Configure

Managed 24+2G Switch : VLAN Support Configuration

VLAN Mode : PortBased

action-> <Quit> <Edit> <Save> <Previous Page> <Next Page>

Tab=Next Item BackSpace=Previous Item Quit=Previous Menu Enter= Select Item

VLAN Mode control setting:

PortBased Port-based VLAN is used.
802.1Q IEEE 802.1Q VLAN is used
Disabled VLAN function is disabled.

Note: When VLAN mode is changed, the switch must be reboot to make the change effective.

If 802.1Q mode is selected, some additional settings are required as follows:

Managed 24+2G Switch : VLAN Support Configuration

VLAN Mode : 802.1Q

Port	PVID	IngressFilter1	IngressFilter2
		NonMember Drop	Untagged Drop
PORT1	1	FORWARD	DROP
PORT2	3	FORWARD	FORWARD
PORT3	1	DROP	FORWARD
PORT4	1	DROP	FORWARD
PORT5	1	DROP	FORWARD
PORT6	1	DROP	FORWARD
PORT7	1	DROP	FORWARD
PORT8	1	DROP	FORWARD

action-> <Quit> <Edit> <Save> <Previous Page> <Next Page>

Tab=Next Item BackSpace=Previous Item Quit=Previous Menu Enter= Select Item

Per port control settings:

PVID : Port VID

Optional values - 1 ~ 255

Ingress Filter / NonMember Drop: Drop or forward input VLAN tagged frames whose VID does not match PVID associated to the input port. This rule is applied only when input port is not the member port of the associated VLAN group. Setting options - DROP, FORWARD

Ingress Filter / UnTagged Drop: Drop or forward input untagged frames
Options - DROP, FORWARD

3.3.3.2 Create a VLAN Group

Create a Port-based VLAN group

```
-----
                          Add a VLAN Group
VLAN Name: [Vlan2    ] Grp ID: [2  ](1-4094)

Port      Member
-----
PORT1     Member
PORT2     Member
PORT3     No
PORT4     No
PORT5     No
PORT6     No
PORT7     No
PORT8     No

action->  <Quit>  <Edit>  <Save>  <Previous Page>  <Next Page>
-----
Tab=Next Item BackSpace=Previous Item Quit=Previous Menu Enter= Select Item
-----
```

New Port-based VLAN group settings:

VLAN name : Give a name to this new VLAN

Grp ID : Give an ID number to this new VLAN (Valid values 1-4094)

Member : The port specified is the member to this new VLAN.

Note:

If trunk groups exist, they are also listed after PORT26 and labeled TRK1, TRK2 .. and etc.. They also can be configured as VLAN member.

Create an 802.1Q VLAN

Add a VLAN Group

VLAN Name: [Vlan2] VLAN ID: [2](1-4094)

Protocol VLAN : None

Port	Member
PORT1	UnTagged
PORT2	Tagged
PORT3	UnTagged
PORT4	No
PORT5	No
PORT6	No
PORT7	No
PORT8	No

action-> <Quit> <Edit> <Save> <Previous Page> <Next Page>

Tab=Next Item BackSpace=Previous Item Quit=Previous Menu Enter= Select Item

New 802.1Q VLAN settings:

VLAN name : Give a name to this new VLAN

VLAN ID : Give a VID to this new VLAN (Valid values: 2-4094)

Protocol VLAN : Select protocol type.

Options - None

- IP, ARP, AppleTalk / NetBIOS, Novell IPX,
- Banyan Vines C4 / Novell IPX (raw Ethernet)
- Banyan Vines C5 / Spanning Tree Protocol BPDU
- Banyan Vines AD / Null SAP, DECnet MOP 01
- DECnet MOP 02, DECnet DPR, DECnet LAT
- DECnet LAVC, IBM SN, X.75 Internet, X.25 Layer 3

Member : Give a member setting, Options -

UnTagged : the specified port is a member port and outgoing frames are not tagged.

Tagged : the specified port is a member port and outgoing frames are tagged.

No : the specified port is not a member port

Note:

If more than two VLAN groups are configured with same protocol value, make sure the member ports of those groups are not overlapping.

3.3.3.3 Edit / Delete a VLAN Group

Example to select one VLAN group for editing or deleting:

```
-----  
      NAME      VI D      NAME      VI D  
-----  
      DEFAULT   1  
      VI an2    2
```

```
action-> <Quit> <Edit> <Delete> <Previous Page> <Next Page>
```

```
-----  
Tab=Next Item BackSpace=Previous Item Quit=Previous Menu Enter= Select Item  
-----
```

Choose the VLAN group that you want to edit or delete and then press enter.

Note:

The VLAN Name and VLAN ID cannot be modified. Default VLAN VID=1 can not be deleted.

Example to edit Vlan2 group:

```
-----
                Edit a VLAN Group
VLAN Name: [Vlan2 ] VLAN ID: [2 ](1-4094)
Protocol VLAN : Appl eTalk/NetBI OS

Port      Member
-----
PORT1    UnTagged
PORT2    Tagged
PORT3    UnTagged
PORT4    No
PORT5    No
PORT6    No
PORT7    No
PORT8    No

action->  <Quit>  <Edit>  <Save>  <Previous Page>  <Next Page>
-----
Tab=Next Item BackSpace=Previous Item Quit=Previous Menu Enter= Select Item
-----
```

3.3.3.4 Groups Sorted Mode

Set sorted mode for VLAN groups shown in **Edit/Delete a VLAN group** page as follows and the options are **Sorted_by_Name** and **Sorted_by_VID**:

```
-----
Managed 24+2G Switch : Group Sorted Selection

Group Sorted : Sorted_by_Name

action->  <Edit>  <Save>  <Quit>
-----
Tab=Next Item BackSpace=Previous Item Quit=Previous Menu Enter= Select Item
-----
```

3.3.4 Misc Configuration

Managed 24+2G Switch : Misc Configuration

MAC Age Interval
Broadcast Storm Filtering
Max bridge transmit delay bound
Port Security
Collision Retry Forever
Hash Algorithm
Previous Menu

Configure the MAC aging time

Tab=Next Item BackSpace=Previous Item Quit=Previous Menu Enter= Select Item

3.3.4.1 MAC Age Interval

Managed 24+2G Switch : MAC Aging Time

MAC Age Interval (sec) [300] : 300
(disable: 0, valid value: 300-765)

action-> <Edit> <Save> <Quit>

Tab=Next Item BackSpace=Previous Item Quit=Previous Menu Enter= Select Item

Set the time interval that an inactive MAC address remained in the switch MAC address table. Options - 0=Disable, 300=Default, 300 ~ 765 seconds

3.3.4.2 Broadcast Storm Filtering

Managed 24+2G Switch : Broadcast Storm Filter Mode

Broadcast Storm Filter Mode : NO

action-> <Edit> <Save> <Quit>

Tab=Next Item BackSpace=Previous Item Quit=Previous Menu Enter= Select Item

Broadcast storm protection control setting:

Threshold options - NO, 5%, 10%, 15%, 20%, 25%

The threshold is the percentage of the total packet buffer occupied by queued broadcast packets. Upon reaching the threshold, broadcast storm filtering mechanism is activated and further incoming broadcast packets are dropped.

3.3.4.3 Max Bridge Transmit Delay Bound

Managed 24+2G Switch : Max Bridge Transmit Delay Bound

Max bridge transmit delay bound : OFF

Low Queue Delay Bound : ENABLE

Low Queue Max Delay Time : 255 (2ms/unit)

action-> <Edit> <Save> <Quit>

Max bridge transmit delay bound: Limit the packets queuing time in switch. If enabled and queuing time expired, the queued packets will be dropped.
Options - OFF (default), 1sec, 2sec, 4sec

Low Queue Delay Bound: Limit the low priority packets queuing time in switch. If enabled and queuing time expired, the low priority packets queued in switch will be sent.

Low Queue Max Delay Time: The maximal time that a low priority packet will be queued in switch.
Options - 1~255, 255=default, (2ms/unit)

Note:

Make sure Max bridge transit delay bound control is enabled when Low Queue Delay Bound control is set to ENABLE.

3.3.4.4 Port Security

Managed 24+2G Switch : Port Security

Port	Enable Security (disable MAC Learning)
------	---

PORT1	Enabled
PORT2	Enabled
PORT3	Enabled
PORT4	Disabled
PORT5	Disabled
PORT6	Disabled
PORT7	Disabled
PORT8	Disabled

act on-> <Quit> <Edit> <Save> <Previous Page> <Next Page>

A port in security mode will be locked and disabled to perform further MAC address learning. Only the incoming packets with source MAC address already existing in the switch MAC address table can be forwarded normally. Otherwise, the packets are dropped.

Options - Enabled, Disabled

For specific security application, user can disable the port from learning any new MAC addresses, then use the static MAC addresses operation to define a list of MAC addresses that are allowed to pass through the secure port.

3.3.4.5 Collision Retry Forever

Managed 24+2G Switch : Collision Retry Forever

Collision Retry Forever : Enabled

action-> <Edit> <Save> <Quit>

Collision Retry control setting for half duplex mode :

Options - Enabled = collision retry forever

Disabled = collision retry 48 times then drop frames

3.3.4.6 Hash Algorithm

Managed 24+2G Switch : Hash Algorithm

Hash Algorithm : Enabled

action-> <Edit> <Save> <Quit>

Hash method for MAC address table :

Options - CRC-Hash = Use CRC hash for table index

DirectMap = Use direct map for table index

Note:

It is recommended not to change the default value.

3.3.5 Administration Configuration

Managed 24+2G Switch : Device Configuration

Change Username
Change Password
Device Information
IP Configuration
Previous Menu

3.3.5.1 Change Username

Managed 24+2G Switch : UserName Configuration

UserName : Admin

action-> <Edit> <Save> <Quit>

The user name is authorized to login into Console, Telnet, Web management interfaces.

3.3.5.2 Change Password

Managed 24+2G Switch : Password Configuration

Old Password : xxxx

New Password : xxxx

enter again : xxxx

action-> <Edit> <Save> <Quit>

The password is used together with UserName for login operation.

3.3.5.3 Device Information

Managed 24+2G Switch : Device Configuration

Name : KS-2260

Description : 24+2G Fast Ethernet switch

Location : Tech support

Contact : David

action-> <Edit> <Save> <Quit>

Each device unit can be configured with above information for management purpose.

3.3.5.4 IP Configuration

Managed 24+2G Switch : Device Configuration

DHCP : Disabled
IP Address : 192.168.0.2
Subnet Mask : 255.255.255.0
Gateway : 192.168.0.1

action-> <Edit> <Save> <Quit>

IP related parameters assigned to this switch device:

DHCP : DHCP client function setting

Enable : enable DHCP client function to get a dynamic IP address

Disable : disable DHCP client function and use current IP address

IP Address : Current IP address assigned to the switch unit

Subnet_Mask : Subnet mask assigned to the switch unit

Gateway : Default gateway IP address assigned to the switch unit

Note:

1. If DHCP is enabled, the displayed IP address is the IP address given by DHCP server. Any modification to this IP address is ignored.
2. If DHCP is enabled and no DHCP server is available in your network, current IP address is used.
3. A modified IP address is accepted and will be saved only when DHCP setting is disabled.

3.3.6 Port Sniffer Configuration

Managed 24+2G Switch : Port Sniffer

Sniffer Mode : Rx
Sniffer Port : PORT1
Monitored Port:

Port	Member

PORT1	-
PORT2	-
PORT3	V
PORT4	-
PORT5	V
PORT6	-
PORT7	-
PORT8	-

action-> <Quit> <Edit> <Save> <Previous Page> <Next Page>

Control settings are:

Sniffer Mode : Specify the traffic type for monitoring

Options - Disable sniffer, Rx=incoming, Tx=outgoing, Both=Rx&Tx

Sniffer Port : Specify the port where performs monitoring.

Monitored Port : Select the ports whose traffic will be duplicated to the sniffer port. Press Space key for selection.

3.3.7 Priority Configuration

Managed 24+2G Switch : The Priority Configuration

Port Static Priority
802.1p Priority
Previous Menu

Two priority methods are provided:

- Port Static Priority (Port-based Priority)
- 802.1p Priority

Note:

The switch uses the following rules:

1. Applies Static Priority method first for tagged or untagged packets.
2. If port static priority is disabled, applies 802.1p Priority method.
3. Untagged packets are treated as low priority.

3.3.7.1 Static Priority

Managed 24+2G Switch : Port Priority

Port	Priority
-----	-----
PORT1	Low
PORT2	Low
PORT3	High
PORT4	High
PORT5	Disable
PORT6	Disable
PORT7	Disable
PORT8	Disable

acti on-> <Quit> <Edit> <Save> <Previous Page> <Next Page>

Specify the static priority level for each port.

The options are:

Disable: Port priority is disabled. 802.1p priority method is applied.

Low: All incoming packets are treated as low priority.

High: All incoming packets are treated as high priority.

3.3.7.2 802.1p Priority

Managed 24+2G Switch : 802.1p Priority Configuration

Priority 0 LOW
Priority 1 LOW
Priority 2 LOW
Priority 3 LOW
Priority 4 HIGH
Priority 5 HIGH
Priority 6 HIGH
Priority 7 HIGH

QoSMode : First Come First Service

action-> <Quit> <Edit> <Save>

Priority 0 ~ 7 : Packet priority value map to high or low level.

Options - Low = low priority packet, High = high priority packet

QoSMode : Service policy how output ports serve the queued packets

Options - **First Come First Service** = by queued sequence (no priority)

All High before Low = high priority packets first

High/Low Queue Service Ratio => H[x] : L[x], where x = 1~7

3.3.8 MAC Address Configuration

Managed 24+2G Switch : MAC Address Configuration

Static MAC Address

Filtering MAC Address

Previous Menu

3.3.8.1 Static MAC Address

Managed 24+2G Switch : Static MAC Address Configuration

MAC Address	Port Num	Vlan ID	MAC Address	Port Num	Vlan ID
-----			-----		

action-> <Quit> <Add> <Edit> <Delete> <Previous Page> <Next Page>

This configuration allows you to <add> more than one specific and static MAC addresses into the switch MAC address table. Those static addresses will stay in table permanently and will not be removed even when aging time out or the switch is powered off. <Edit> and <Delete> functions are also provided to maintain those static MAC addresses.

Add static MAC address

Managed 24+2G Switch : Add Static MAC Address

MAC Address : 0040F6FE0005

Port Num : PORT3

Vlan ID : 2

acti on-> <Edi t> <Save> <Qui t>

MAC Address : the Ethernet MAC address

Port Num : press <Space> key to select the port number

Vlan ID : If tag-based (802.1Q) VLAN is enabled on the switch, each static address is associated with one VLAN. Type the VID to associate with the MAC address. For port-based VLAN, this setting is not displayed.

Select one static MAC address to edit or delete

MAC Address Port Num Vlan ID MAC Address Port Num Vlan ID

0040F6FE0005 PORT3 2

0040F6FE0A01 PORT5 2

acti on-> <Qui t> <Add> <Edi t> <Del ete> <Previ ous Page> <Next Page>

Use [Tab] or [BackSpace] key to choose the target address for <Edit> or <Delete> actions.

3.3.8.2 Filtering MAC Address

Refer to Chapter 1 for description of MAC address filtering function. The operations to Add/Edit/Delete a filter MAC address are similar to the operations for static MAC address table. The following page shows an example of filter MAC address table:

```
-----  
MAC Address  Vlan ID          MAC Address  Vlan ID  
-----  
  
action->  <Quit> <Add> <Edit> <Delete> <Previous Page> <Next Page>  
-----
```

Example to enter a new filter address:

```
-----  
Managed 24+2G Switch : Add Filter MAC Address  
  
MAC Address   : 0040F6FE0005  
Vlan ID      : 2  
  
action->  <Edit> <Save> <Quit>  
-----
```

MAC Address : Type the MAC address to filter.

Vlan ID : If tag-based (802.1Q) VLAN is enabled on the switch, type the VID to associate with the filter MAC address.

3.4 Protocol Related Configuration

Managed 24+2G Switch : The Protocol Related Configuration

STP
SNMP
GVRP
IGMP
LACP
802.1x
Previous Menu

3.4.1 STP

Managed 24+2G Switch : Spanning Tree Protocol

STP Enable
System Configuration
Perport Configuration
Previous Menu

Refer to Chapter 1 for description about Spanning-Tree Protocol and its related parameters, status and settings.

STP Enable

Managed 24+2G Switch : STP Enabled/Disabled Configuration

STP : Enabled

action-> <Edit> <Save> <Quit>

Spanning Tree function can be enabled or disabled. Press **Space** key to select enable or disable.

System Configuration

Managed 24+2G Switch : STP System Configuration

Root Bridge Information

Configure Spanning Tree Parameters

Priority : 32768
Mac Address : 0040F6FE0008
Root_Path_Cost : 0
Root Port : Root
Max Age : 20
Hello Time : 2
Forward Delay : 15

Priority (0-65535) : 32768
Max Age (6-40) : 20
Hello Time (1-10) : 2
Forward_Delay_Time (4-30) : 15

action-> <Edit> <Save> <Quit>

Current spanning tree information about the Root Bridge is shown on the left side and new values for STP parameters are configured on the right side.

The settings are:

Priority : The priority is assigned to the switch. The higher value is lower priority. Range: 0 - 65535

Max Age : The number of seconds a bridge waits without receiving Spanning Tree protocol configuration messages before attempting a reconfiguration. Valid value : 6 ~ 40.

Hello Time : The number of seconds between the transmission of Spanning Tree protocol configuration messages. Valid value : 1 ~ 10.

Forward Delay Time : The number of seconds a port waits before changing from its Spanning Tree Protocol learning and listening states to the forwarding state. Valid value : 4 ~ 30.

For descriptions of STP status and parameters, refer to Chapter 1 - Spanning Tree Protocol section.

Perport Configuration

Managed 24+2G Switch : STP Port Configuration

Port	PortState	PathCost	Priority
PORT1	Forwarding	10	128
PORT2	Forwarding	10	128
PORT3	Forwarding	10	128
PORT4	Forwarding	10	128
PORT5	Forwarding	10	128
PORT6	Forwarding	10	128
PORT7	Forwarding	10	128
PORT8	Forwarding	10	128

action-> <Quit> <Edit> <Save> <Previous Page> <Next Page>

PortState : Spanning tree port state status

Possible states - Forwarding, Blocking, Listening, Learning

Control settings:

PathCost : Specifies the path cost for each port. The possible range is 1 to 65535. The recommended path cost is 1000 divided by LAN speed in megabits per second.

Priority : Specify STP port priority for each port. The possible priority range is 0 through 255 (decimal). The default is 128. If all ports have the same priority value, the lowest port number forwards the spanning-tree frames.

For descriptions of STP status and parameters, refer to Chapter 1 - Spanning Tree Protocol section.

3.4.2 SNMP

Managed 24+2G Switch : SNMP Protocol

System Options
Community Strings
Trap Managers
Previous Menu

Use this page to setup SNMP related parameters and SNMP trap hosts related parameters.

3.4.2.1 System Options

Managed 24+2G Switch : System Options Configuration

System Name :

.....

System Contact :

.....

System Location :

.....

action-> <Quit> <Edit> <Save>

Settings:

System Name : Specify a logical name to the switch unit.

System Contact : Specify the name of contact person regarding the unit.

System Location : Type the location where the switch unit is located.

These settings are used for SNMP MIB-II objects.

3.4.2.2 Community Strings

Managed 24+2G Switch : SNMP Community Configuration

Community Name	Write Access
----------------	--------------

public	Restricted
private	Unrestricted

action-> <Add> <Edit> <Delete> <Save> <Quit>

This page shows current Community strings which are allowed to access MIB objects of the switch unit via SNMP management interface. Up to four communities can be configured. Action commands are:

<Add> : Create a new community string.

<Edit> : Edit settings.

<Delete> : Select a string to delete

Add/Edit a Community String

Managed 24+2G Switch : Add SNMP Community

Community Name	:	Command-1
Write Access	:	Restricted

action-> <Edit> <Save> <Quit>

Community Name : Specify the name of one community string which is allowed to access this switch unit.

Write Access : Specify the access right authorized to the community name.
Options - Restricted = Read only, Unrestricted =Read/Write

3.4.2.3 Trap Managers

A trap manager is a management station that allows to receive SNMP traps. An SNMP trap is issued by the switch when the associated trap event occurs in the switch. A trap manager is defined by its IP address and a community string. Up to three trap managers can be configured.

Managed 24+2G Switch : Trap Managers Configuration

IP	Community Name
----	----------------

action-> <Add> <Edit> <Delete> <Save> <Quit>

Action commands:

<Add> : Create a new trap manager

<Edit> : Edit a trap manager settings

<Delete> Delete a trap manager

Add/Edit a trap manager

Managed 24+2G Switch : Add SNMP Trap Manager

IP : 192.168.223.100

Community Name : public

action-> <Edit> <Save> <Quit>

Trap manager settings:

IP : IP address of the trap manager.

Community Name : Community name associated to the trap manager

3.4.3 GVRP

This page you can enable or disable the GVRP (GARP VLAN Registration Protocol) support.

Managed 24+2G Switch : GVRP Configuration

GVRP : Enabled

action-> <Edit> <Save> <Quit>

Options - Enabled, Disabled

3.4.4 IGMP

This page you can enable or disable the IGMP support.

Managed 24+2G Switch : IGMP Configuration

IGMP : Enabled

action-> <Edit> <Save> <Quit>

Options - Enabled, Disabled

3.4.5 LACP

This menu list is used to configure LACP trunk groups.

Managed 24+2G Switch : LACP Configuration

Working Ports Setting
State Activity
LACP Status
Previous Menu

3.4.5.1 Working Port Setting

Managed 24+2G Switch : LACP Group Configuration

Group	LACP	LACP Work Port Num
TRK1	Di sabled	4

acti on-> <Edi t> <Save> <Qui t>

Group : Display the trunk group ID.

LACP : Display the trunk group LACP setting.

Setting:

LACP Work Port Num : Specify the maximal number of ports can be aggregated at the same time. A trunk group with LACP disabled must be specified with 4. An LACP enabled trunk group can be specified up to 2.

3.4.5.2 State Activity

Managed 24+2G Switch : LACP Port Active State Configuration

Port	State Activity	Port	State Activity
1	Active	14	Passive
2	Active	15	Passive
3	Active	16	Passive
4	Active	17	Passive
5	Passive	18	Passive
6	Passive	19	Passive
7	Passive	20	Passive
8	Passive	21	Passive
9	Passive	22	Passive
10	Passive	23	Passive
11	Passive	24	Passive
12	Passive	25	Passive
13	Passive	26	Passive

action-> <Edit> <Save> <Quit>

Use <Edit>.command to set LACP state activity mode for each port.

State Activity setting options -

Active : The port automatically sends LACP protocol packets. If it belongs to a trunk group which is set to LACP mode.

Passive : The port does not automatically send LACP protocol packets and responds only if it receives LACP protocol packets from the opposite device.

Note:

If a trunk group is set to LACP mode, all its member ports are set to [Active] default.

3.4.5.3 LACP Status

Managed 24+2G Switch : LACP Group Status

Group Key : 1

Port_No : 1 2 3 4

action-> <Quit> <Previous Page> <Next Page>

This page shows LACP status of each trunk group.

3.4.6 802.1X

Managed 24+2G Switch : 802.1x protocol

802.1x Enable

System Configuration

PerPort Configuration

Misc Configuration

Previous Menu

This menu is used to configure 802.1X function related settings. For more information about 802.1X function, refer to Section *1.5.10 802.1X Port-Based Network Access Control*.

3.4.6.1 Enable 802.1X Protocol

Managed 24+2G Switch : 802.1x Enabled/Disabled Configuration

802.1x : Enabled

action-> <Edit> <Save> <Quit>

This menu is used to enable 802.1X function of the switch.

3.4.6.2 802.1X System Configuration

Managed 24+2G Switch : 802.1x System Configuration

Radius Server IP: xxx.xxx.xxx.xxx

Shared Key : 12345678

NAS Identifier : NAS_L2_SWITCH

Server Port : 1812

Accounting Port : 1813

action-> <Edit> <Save> <Quit>

This menu is used to setup Radius server related parameters as follows:

Radius Server IP : IP address of the Radius server

Shared Key : an encryption key for use during authentication sessions with the specified Radius server. It must match the key used on the Radius server.

NAS Identifier : identifier for this Radius client (this switch)

Server Port : the UDP destination port for authentication requests to the specified Radius server

Accounting Port : the UDP destination port for accounting requests to the specified Radius server

3.4.6.3 802.1X Per Port Configuration

Managed 24+2G Switch : 802.1x Port Status

(Force Unauth= Fu, Force Au=Fa, Auto=Au, None=No)

Port	Status

PORT1	No
PORT2	No
PORT3	No
PORT4	No
PORT5	No
PORT6	No
PORT7	No
PORT8	No

action-> <Quit> <Edit> <Save> <Previous Page> <Next Page>

This menu is used to configure per-port 802.1x mode. The options are:

Au (Auto) - The port is set to the Authorized or Unauthorized state in accordance with the outcome of an authentication exchange between the Supplicant and the Authentication Server.

Fa (Forced Authorized) - The port is forced to be in authorized state.

Fu (Forced Unauthorized) - The port is forced to be in unauthorized state.

No (None) - The port is not necessary authorized.

3.4.6.4 802.1X Misc. Configuration

Managed 24+2G Switch : 802.1x Misc Configuration

Quiet-period <0..65535, default t=60> : 60
Tx-period <0..65535, default t=30> : 30
Supplicant-timeout <0..300, default t=30> : 30
Server-timeout <0..300, default t=30> : 30
ReAuthMax <1..10, default t=2> : 2
Reauth-period <0..9999999, default t=3600> : 3600

action-> <Edit> <Save> <Quit>

This menu is used to setup 802.1x protocol related timers and parameters as follows:

Quiet Period - the period during which the port does not try to acquire a supplicant

Tx Period - the period the port waits to retransmit the NEXT EAPOL PDU during an authentication session

Supplicant Timeout - the period of time the switch waits for a supplicant response to an EAP request

Server Timeout - the period of time the switch waits for a server response to an authentication request

ReAuthMax - the number of authentication attempts that must time-out before authentication fails and the authentication session ends.

Reauth Period - the period of time after which the connected radius clients must be re-authenticated

Note: The unit of the timer settings is second.

3.5 Status and Counters

Managed 24+2G Switch : Status and Counters

Port Status

Port Counters

System Information

Previous Menu

Menu functions:

Port Status : display the status of all switched ports and trunk groups.

Port Counters : display the statistic counters of each ports.

System Information : display system related information, cooling fan status, and all slot module status.

3.5.1 Port Status

Managed 24+2G Switch : Port Configuration

Port	Link	InRate	OutRate				Flow
	Status	(100K)	(100K)	Enable	Auto	Spd/Dpx	Control
PORT1	Down	0	0	No	AUTO	100 Full	On
PORT2	Down	0	0	No	AUTO	100 Full	On
PORT3	Down	0	0	No	AUTO	100 Full	On
PORT4	Down	0	0	No	AUTO	100 Full	On
PORT5	Up	0	0	Yes	AUTO	100 Full	Off
PORT6	Down	0	0	No	AUTO	100 Full	On
PORT7	Down	0	0	No	AUTO	100 Full	On
PORT8	Down	0	0	No	AUTO	100 Full	On

action-> <Quit> <Previous Page> <Next Page>

This page display current port status for all switched ports. The status are:

Link Status : Display port link status

InRate : Display the input rate control (100K/unit) setting value.

OutRate : Display the output rate control (100K/unit) setting value.

Enable : Display the port function setting. (Yes=Port is enabled, No=Port is disabled)

Auto : Display the port Nway mode: Auto , Nway_Force , Force.

Spd/Dpx : Display the port speed and duplex status.

FlowControl : Display the flow control status.

Note:

In auto / Nway force mode, it displays the flow control status after negotiation. In force mode, it displays the flow control setting.

3.5.2 Port Counters

Managed 24+2G Switch : Port Counters

Port	TxGoodPkt	TxBadPkt	RxGoodPkt	RxBadPkt	TxAbort	Collision	DropPkt
PORT1	0	0	0	0	0	0	0
PORT2	0	0	0	0	0	0	0
PORT3	0	0	0	0	0	0	0
PORT4	0	0	0	0	0	0	0
PORT5	81	0	54	0	0	0	0
PORT6	0	0	0	0	0	0	0
PORT7	0	0	0	0	0	0	0
PORT8	0	0	0	0	0	0	0

action-> <Quit> <Reset All> <Previous Page> <Next Page>

The page displays some port statistic counts. The counts are:

TxGoodPkt : Good Tx packet count

TxBadPkt : Bad Tx packet count

RxGoodPkt : Good Rx packet count

RxBadPkt : Bad Rx packet count

TxAbort : Aborted Tx packet count

Collision : Collision count

DropPkt : Dropped packet count

Use <**Reset All**> to clear the counters of the selected port.

3.5.3 System Information

Managed 24+2G Switch : System Information

MAC Address : 0040F6FE0005
Firmware version : x. x
ASIC version : x. xx
PCBA version : x. xx

G1 Module Type : N/A [N/A]
G2 Module Type : N/A [N/A]
F23 Module Type : N/A [N/A]
F24 Module Type : N/A [N/A]

FAN-1 Status : Normal
FAN-2 Status : Normal

The system information includes:

MAC Address : The unique MAC address assigned to this switch unit

Firmware Version : Display the switch firmware version.

ASIC Version : Display the main controller version.

PCBA Version : Display the switch Hardware version.

G1 Module Type : Display module information in G1 slot.

G2 Module Type : Display module information in G2 slot.

F23 Module Type : Display module information in F23 slot.

F24 Module Type : Display module information in F24 slot.

FAN-1 Status : Display status of Cooling Fan1.

FAN-2 Status : Display status of Cooling Fan2.

3.6 Reboot Switch

Managed 24+2G Switch : Restart Configuration

Restart

Default

Previous Menu

3.6.1 Restart

This command will reboot the switch with current configuration setting values. Confirmation prompt is:

Rebooting device

Do you want to continue? (y/n)

3.6.2 Default

This command will reboot the switch with default configuration. Confirmation prompt is:

Resetting to the default will restart the system
automatically !!!!

Do you want to continue? (y/n)

Refer to Appendix A for factory default values.

3.7 TFTP Update Firmware

Managed 24+2G Switch : TFTP Update Firmware Configuration

TFTP Update Firmware
TFTP Restore Configuration
TFTP Backup Configuration
Previous Menu

This menu supports :

TFTP Update Firmware : Update the switch firmware via TFTP

TFTP Restore Configuration : Download default configuration file to the switch from the TFTP server

TFTP Backup Configuration : Backup current configuration settings of the switch as a image file to the TFTP server

3.7.1 TFTP Update Firmware

Managed 24+2G Switch : TFTP Update Firmware

TFTP Server : 192.168.0.15

Remote File Name : image.bin

action-> <Edit> <Save> <Quit>

The steps to use TFTP to update switch firmware are:

1. Start your TFTP server and place the image file of the new firmware on the TFTP server.
2. Use <Edit> command to specify TFTP server IP and file name:

TFTP Server : Type the IP address of your TFTP server.

Remote File Name : Type the image file name of the new firmware

5. Press [Ctrl+A] to go back to action line.
6. Use <Save> command to start downloading the image file.
7. When command completed successfully, the image file download finished too.
8. Restart switch to start the new firmware by the command as follows:

Main Menu

-> **Reboot Switch**

-> **Restart**

3.7.2 TFTP Restore Configuration

Managed 24+2G Switch : Restore Configuration File

TFTP Server : 192.168.0.15
Remote File Name : data.dat

action-> <Edit> <Save> <Quit>

The steps to use TFTP to restore switch configuration are:

1. Start your TFTP server and place the image file of new configuration file on the TFTP server.
2. Use **<Edit>** command to specify TFTP server and file name:

TFTP Server : Type the IP address of your TFTP server.

Remote File Name : Type the file name of the new configuration

5. Press [**Ctrl+A**] to go back to action line.
6. Use **<Save>** command to start downloading the file.
7. When command completed successfully, the image file download finished too.
8. Use **Default** command to reboot the switch as follows:

Main Menu

-> **Reboot Switch**

-> **Default**

3.7.3 TFTP Backup Configuration

Managed 24+2G Switch : Upload Configuration File

TFTP Server : 192.168.0.15

Remote File Name : newdata.dat

action-> <Edit> <Save> <Quit>

To use TFTP to upload current switch configuration and save it as a backup image file onto TFTP server. The steps are:

1. Start your TFTP server.
2. Use <Edit> command to specify TFTP server and file name:

TFTP Server : Type the IP address of your TFTP server.

Remote File Name : Type the file name to save current configuration

5. Press [Ctrl+A] to go back to action line.
6. Use <Save> command to start uploading current switch configuration.
7. When command completed successfully, the image file upload finished too.

4. SNMP Management

SNMP management are performed at a network management station running SNMP network management application manager software. The following figure illustrates an example model:

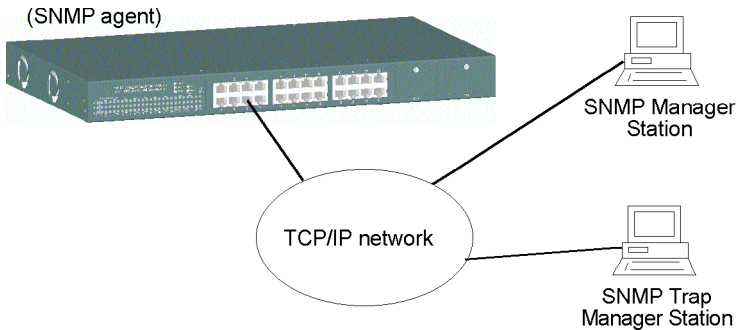

The switch unit serves as an SNMP agent and provides the capabilities that allows network administrators via SNMP protocol to set parameters and view switch status defined in the standard MIB-II and private MIB. A trap manager is a management station that allows to receive SNMP traps. An SNMP trap is issued by the switch when the associated trap event occurs in the switch.

4.1 Configuring SNMP Settings via Console Operation

Before performing SNMP operation, proper SNMP settings must be configured. The SNMP related settings are:

Name : Logic name to identify the switch unit

Location : Location where the switch unit is installed

Contact : Contact person regarding the switch unit

Community string : SNMP communities to which the SNMP manager belongs and access right to the switch unit (read only or read/write)

Trap Managers : IP addresses of trap managers to which a trap is issued and the community to which the trap manager belongs.

Up to four SNMP communities and up to three trap managers are supported by the system SNMP agent.

4.2 SNMP MIB-2 and Private MIB

Use the SNMP management application software to compile the MIB file first before performing any management operation. The following MIB standards are supported:

RFC1213 MIB-2

RFC1493 Bridge MIB

RFC1643 Ethernet-like MIB

RFC1271 RMON MIB statistics, history, alarm, event group

Private MIB (Device Specific)

The following MIB-2 objects are related to the switched ports and are indexed by a port number 1 ~ 27 (27 = CPU port):

<u>Port MIB-2 Objects</u>	<u>Set/Get</u>	<u>Value Options</u>
ifIndex.1 ~ 27	Get	Physical port number
ifDescr.1 ~ 26	Get	text - Port 1~26 on unit 1
ifDescr.27	Get	text - ethernet switch low driver
ifType.1 ~ 27	Get	erhernet-csmacd(6)
ifSpeed.1 ~ 24	Get	100000000=100M, 10000000=10M
ifSpeed.25 ~ 26	Get	100000000=100M, 10000000=10M 1000000000=1000M, 0=No module
ifSpeed.27	Get	10000000 = 10M
ifAdminStatus.1 ~ 27	Set	up(1) = enable port down(2) = disable port
ifAdminStatus.1 ~ 27	Get	up(1) = port is enabled down(2) = port is disabled
ifOperStatus.1 ~ 27	Get	up(1) = port status link up down(2) =port status link down
ifLastChange.1 ~ 27	Get	Time of port status change
ifInOctets.1 ~ 27	Get	Port total bytes received
ifInUcastPkts.1 ~ 27	Get	Port total unicast packet received
ifInNUcastPkts.1 ~ 27	Get	Port total non-unicast packet received
ifInDiscards.1 ~ 27	Get	Port total packet dropped
ifInErrors.1 ~ 27	Get	Port total error packet received
ifOutOctets.1 ~ 27	Get	Port total bytes sent
ifOutUcastPkts.1 ~ 27	Get	Port total unicast packet sent
ifOutNUcastPkts.1 ~ 27	Get	Port total non-unicast packet sent
ifOutDiscards.1 ~ 27	Get	Port total packet aborted
ifOutErrors.1 ~ 27	Get	Port total error packet sent
ifOutQLen.11	Get	Port total output queued packets

The following are device-related private MIB objects:

<u>Private MIB Objects</u>	<u>Set/Get</u>	<u>Value Options</u>
DeviceName.0	Get	KS2260
PortNumber.0	Get	26
F23_Module.0	Get	N/A(0) FX_Module(1)
F23_Module.0	Get	N/A(0) FX_Module(1)
G1_Module.0	Get	N/A(0) TP_10/100/1000T(1) FX_1000SX_SC(2) FX_1000SX_LC(3) FX_1000LX_SC(4) FX_1000LX_SC(5) FX_1000LX_SC(6) FX_1000LX_LC(7) FX_1000LX_LC(8) FX_1000LX_S3_SC(9) FX_1000LX_S5_SC(10) FX_1000LX_S3_SC(11) FX_1000LX_S5_SC(12)
G2_Module.0	Get	Same as G1_Module.0
FanStatus1.0	Get	Normal(0) Warning(1)
FanStatus2.0	Get	Normal(0) Warning(1)

The following MIB objects are provided in v1.154 and later:

1. Set static MAC address entry in Static MAC table.
2. Get Static MAC address table list.
3. Set/Get Port security mode.

Refer to MIB file, ks2260-v1.xx.mib for the details. This file can be used for MIB compiler.

4.3 SNMP Traps

The switch supports the following SNMP traps. When the trap event occurs, the SNMP agent will generate a trap notification to SNMP trap manager stations. Up to three trap managers can be supported. Each trap manager must be configured with : *IP address* and *Community string* which the trap manager belongs.

The provided traps and associated events are:

<u>Trap Name</u>	<u>RFC1157</u>	<u>Event of Trap Generated</u>
Cold Start	Generic	The device is powered on or reboot remotely and complete initialization
Authentication	Generic	SNMP community authentication failure
Port link change	Generic	Any switched port link down
Port link change	Generic	Any switched port link recovery
Fan 1 failure	Specific	Fan 1 failure warning or recovery
Fan 2 failure	Specific	Fan 2 failure warning or recovery

5. Web Management

The managed switch features an http server which can serve the management requests coming from any web browser software over internet or intranet network.

Web Browser

Microsoft Internet Explorer 5.0 or later

Important:

The switch does not support any version of Netscape browser software.

Best Display Resolution

1024 x 768 pixels up

High color (16 bit) up

Set IP Address for the device unit

Before the device can be managed from a web browser software, make sure a unique IP address is configured to the device. Refer to Section 2.7 for how to set IP address and related parameters for the managed switch unit. The parameters are:

- IP address
- Subnet mask
- Default Gateway
- User name
- Password

5.1 Start Browser Software and Making Connection

Start your browser software and enter the IP address of the device unit to which you want to connect. The IP address is used as URL for the browser software to search the device.

URL : `http://xxx.xxx.xxx.xxx/`

Factory default IP address : 192.168.0.2



Login the **Username** and **Password** to enter web management. Refer to Appendix A for factory default values.

5.2 Web Management Home Overview

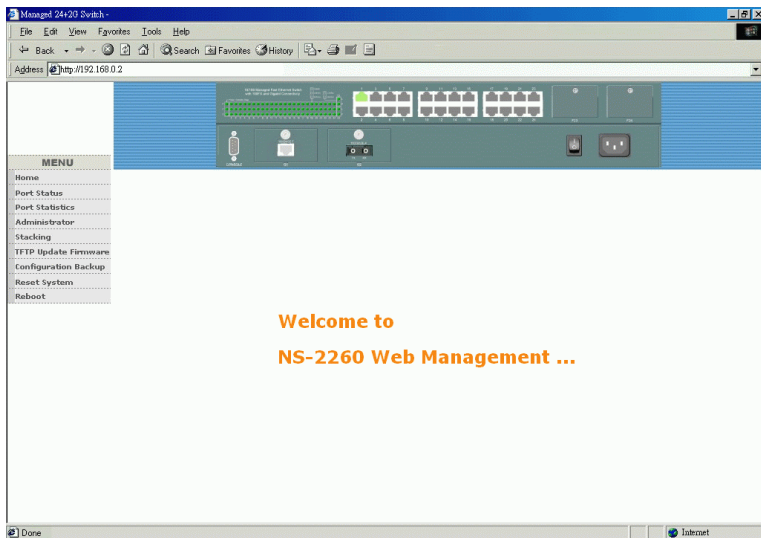

This page provides the following menu list. Each menu is described individually in the following sections.

- Menu
- Port Status
- Port Statistics
- Administrator
- Stacking
- TFTP Update Firmware
- Configuration Backup
- Reset System
- Reboot

5.3 Port status

The screenshot shows a web browser window displaying the 'Port Status' page of a Managed 24x24 Switch. The page title is 'Port Status' and it includes a sub-header: 'The following information provides a view of the current status of the unit.' Below this is a table with columns for Port, State, Link, Negotiation, Speed, Duplex, Flow Control, Rate Control (100K), Priority, and Security. The table lists ports from PORT1 to PORT24 with their respective configurations and current states.

Port	State		Link	Negotiation		Speed		Duplex		Flow Control		Rate Control(100K)		Priority	Security	
	Config	Actual		Config	Actual	Config	Actual	Config	Actual	Config	Actual	Ingr	Egr			
PORT1	On	On	Up	Auto	Auto	100	100	Full	Full	On	On	On	Off	Off	Disable	Off
PORT2	On	On	Down	Auto	Auto	100	100	Full	Full	On	On	On	Off	Off	Disable	Off
PORT3	On	On	Down	Auto	Auto	100	100	Full	Full	On	On	On	Off	Off	Disable	Off
PORT4	On	On	Down	Auto	Auto	100	100	Full	Full	On	On	On	Off	Off	Disable	Off
PORT5	On	On	Down	Auto	Auto	100	100	Full	Full	On	On	On	Off	Off	Disable	Off
PORT6	On	On	Down	Auto	Auto	100	100	Full	Full	On	On	On	Off	Off	Disable	Off
PORT7	On	On	Down	Auto	Auto	100	100	Full	Full	On	On	On	Off	Off	Disable	Off
PORT8	On	On	Down	Auto	Auto	100	100	Full	Full	On	On	On	Off	Off	Disable	Off
PORT9	On	On	Down	Auto	Auto	100	100	Full	Full	On	On	On	Off	Off	Disable	Off
PORT10	On	On	Down	Auto	Auto	100	100	Full	Full	On	On	On	Off	Off	Disable	Off
PORT11	On	On	Down	Auto	Auto	100	100	Full	Full	On	On	On	Off	Off	Disable	Off
PORT12	On	On	Down	Auto	Auto	100	100	Full	Full	On	On	On	Off	Off	Disable	Off
PORT13	On	On	Down	Auto	Auto	100	100	Full	Full	On	On	On	Off	Off	Disable	Off
PORT14	On	On	Down	Auto	Auto	100	100	Full	Full	On	On	On	Off	Off	Disable	Off
PORT15	On	On	Down	Auto	Auto	100	100	Full	Full	On	On	On	Off	Off	Disable	Off
PORT16	On	On	Down	Auto	Auto	100	100	Full	Full	On	On	On	Off	Off	Disable	Off
PORT17	On	On	Down	Auto	Auto	100	100	Full	Full	On	On	On	Off	Off	Disable	Off
PORT18	On	On	Down	Auto	Auto	100	100	Full	Full	On	On	On	Off	Off	Disable	Off
PORT19	On	On	Down	Auto	Auto	100	100	Full	Full	On	On	On	Off	Off	Disable	Off

This page shows all port status in a scroll bar list. The status are dependent on user settings and the negotiation results as follows:

State : Display port function status including -

Config : function setting - On = enable, Off = disable

Actual : status - On = enabled, Off = disabled

Link Status : Down = No Link, UP = active link is established

Auto Negotiation : Display the auto negotiation mode setting and status
Config / Actual

Auto = enable auto negotiation with the specified highest capability

Force = disable auto negotiation and use forced mode

Nway-force = enable auto negotiation with the specified capability

Note : Specified capability means speed and duplex configuration

Speed status : Display port speed setting and status

Config : port speed capability setting

Actual : port speed is used currently

Port 1-24 : 10/100Mbps

G1 port, G2 port : 10/100/1000Mbps

Duplex status : Display duplex setting and status

Config : port duplex capability setting - Full, Half

Actual : port duplex mode is used currently - Full, Half

Flow Control: Display the flow control settings and status

Config/Full : On = enable for full duplex, Off = disable

Config/Half : On = enable for half duplex, Off = disable

Actual : current flow control status

Rate Control : Display the port rate control settings (unit=100K bytes)

Actual/Ingr : Display the port effective ingress rate setting

Actual/Egr : Display the port effective egress rate setting

Off = the rate control is disabled.

Priority : Display the port port-based priority setting

High = the port is high priority port.

Low = the port is low priority port.

Disable = port-based priority is disabled.

Port Security : Display the port security setting (SA MAC learning)

On = security on and SA MAC address learning is stopped

Off = port security off and performs normal MAC address learning

Note : SA = Source MAC address in the received packet

5.4 Port Statistics

Managed 24x24 Switch

Address: http://192.168.0.2

Port Statistics

The following information provides a view of the current status of the unit.

Port	State	Link	TxGoodPkt	TxBadPkt	RxGoodPkt	RxBadPkt	TxAbort	Collision	DropPkt
PORT1	On	Up	2822	0	7132	0	0	0	4073
PORT2	On	Down	0	0	0	0	0	0	0
PORT3	On	Down	0	0	0	0	0	0	0
PORT4	On	Down	0	0	0	0	0	0	0
PORT5	On	Down	0	0	0	0	0	0	0
PORT6	On	Down	0	0	0	0	0	0	0
PORT7	On	Down	0	0	0	0	0	0	0
PORT8	On	Down	0	0	0	0	0	0	0
PORT9	On	Down	0	0	0	0	0	0	0
PORT10	On	Down	0	0	0	0	0	0	0
PORT11	On	Down	0	0	0	0	0	0	0
PORT12	On	Down	0	0	0	0	0	0	0
PORT13	On	Down	0	0	0	0	0	0	0
PORT14	On	Down	0	0	0	0	0	0	0
PORT15	On	Down	0	0	0	0	0	0	0
PORT16	On	Down	0	0	0	0	0	0	0
PORT17	On	Down	0	0	0	0	0	0	0
PORT18	On	Down	0	0	0	0	0	0	0

Reset

This page displays the function, link status, and statistic counters of all ports by a scroll list. The status and counters are:

State : On = port is enabled, Off = port is disabled

Link : port link status, Down = link down, Up = link up

TxGoodPkt : Good transmitted packet count

TxBadPkt : Bad transmitted packet count

RxGoodPkt : Good received packet count

RxBadPkt : Bad received packet count

TxAbort : Aborted packet count

Collision : the number of collisions

DropPkt : Dropped packet count

Press [**Reset**] button to reset all counters.

Click port icons on the switch image to also see a single port counters as follows:

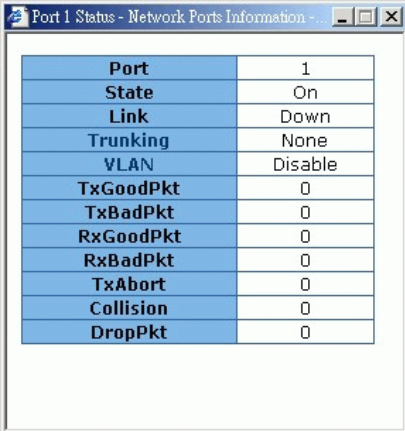

Port	1
State	On
Link	Down
Trunking	None
VLAN	Disable
TxGoodPkt	0
TxBadPkt	0
RxGoodPkt	0
RxBadPkt	0
TxAbort	0
Collision	0
DropPkt	0

5.5 Administrator

Administrator menu provides the following management functions:

- IP address
- Switch settings
- Console port information
- Port controls
- Trunking
- Filter database
- VLAN configuration
- Spanning tree
- Port Sniffer
- SNMP
- Security Manager
- Stack Settings

5.5.1 IP Address

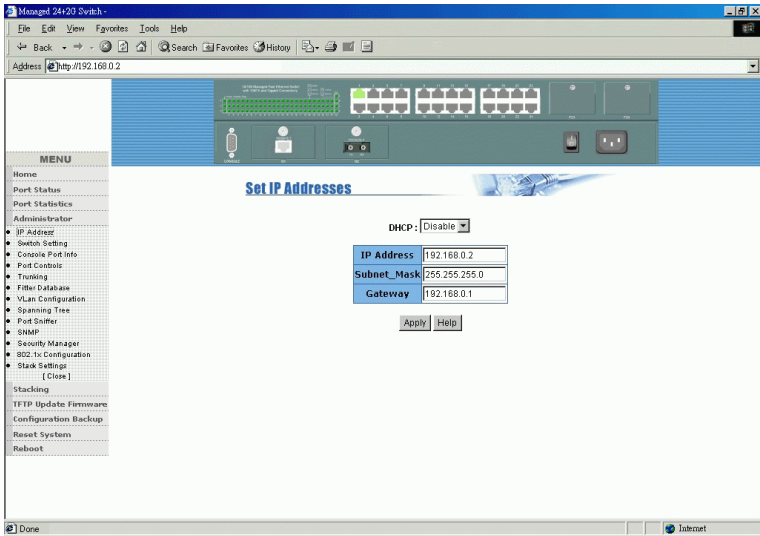

Available settings:

DHCP : DHCP function setting

Enable : enable DHCP client function to get dynamic IP address

Disable : disable DHCP client function and use static IP address

IP Address : Static IP address assigned to the managed switch unit

Subnet_Mask : subnet mask setting

Gateway : Default gateway IP address

Click Buttons:

[Apply] : confirm and apply the setting changes

[Help] : description about the settings

The switch unit must be reset to use the new IP parameters.

5.5.2 Switch Setting

This menu provides the following functions:

Basic : the basic information of the managed switch unit

Module Info : the information of the Gigabit modules installed

Advanced : some switch related settings

5.5.2.1 Basic Information

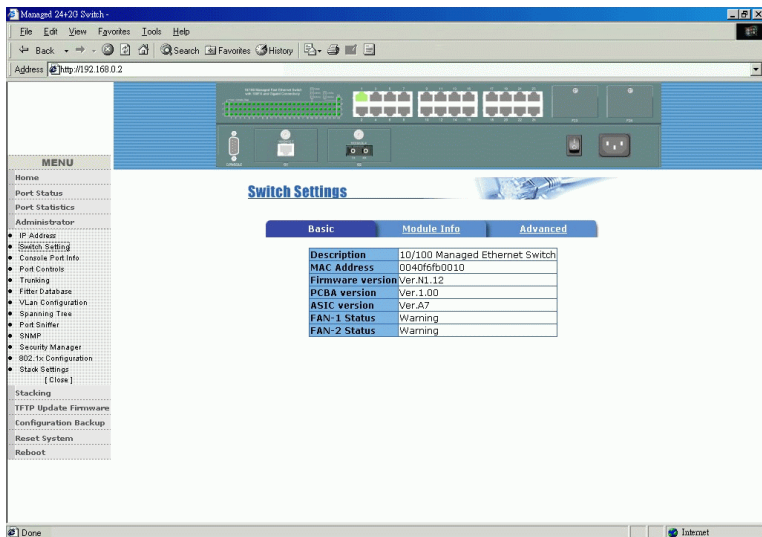

The screenshot shows a web browser window titled "Managed 24x20 Switch" with the address "http://192.168.0.2". The interface includes a navigation menu on the left and a main content area. The "Switch Settings" page is displayed, with the "Basic" tab selected. The table below shows the following information:

Switch Settings			
	Basic	Module Info	Advanced
Description	10/100 Managed Ethernet Switch		
MAC Address	00496fb0010		
Firmware version	Ver.N1.12		
PCBA version	Ver.1.00		
ASIC version	Ver.A7		
FAN-1 Status	Warning		
FAN-2 Status	Warning		

Description : The name of switch type

MAC Address : The unique MAC address assigned to the switch unit

Firmware Version : The firmware version built-in

ASIC Version : The switch controller version of the switch unit

PCBA Version : The hardware version of the switch unit

FAN-1 Status : The status of cooling Fan1 - NORMAL, WARNING

FAN-2 Status : The status of cooling Fan2 - NORMAL, WARNING

5.5.2.2 Module Info

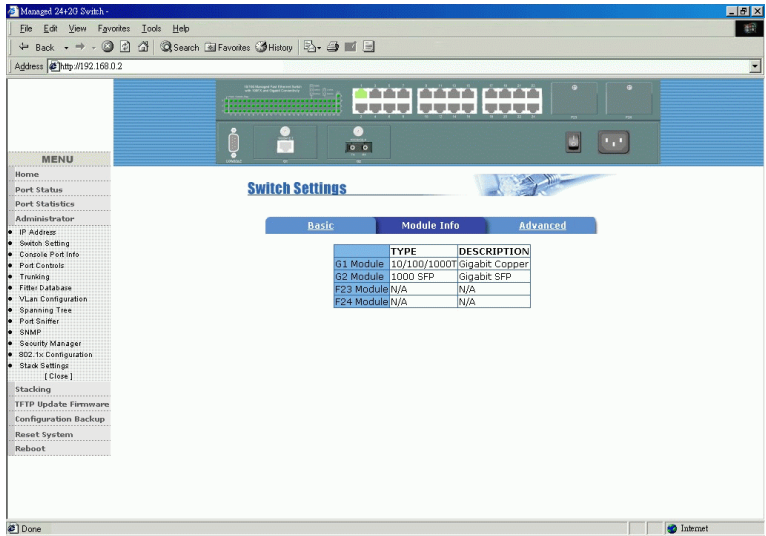

The screenshot shows the web interface of an HP 2424 Switch. The browser address bar displays "http://192.168.0.2". The main content area is titled "Switch Settings" and has three tabs: "Basic", "Module Info", and "Advanced". The "Module Info" tab is selected, showing a table with the following data:

	TYPE	DESCRIPTION
G1 Module	10/100/1000T	Gigabit Copper
G2 Module	1000 SFP	Gigabit SFP
F23 Module	N/A	N/A
F24 Module	N/A	N/A

The left sidebar contains a "MENU" with various configuration options such as Home, Port Status, IP Address, and Stack Settings. The bottom status bar shows "Done" and "Internet".

Module information of Port 23 F23 slot, Port 24 F24 slot, G1 port, and G2 port :

TYPE : The type of the module installed in port slot

DESCRIPTION : The description about the installed module

5.5.2.3 Advanced

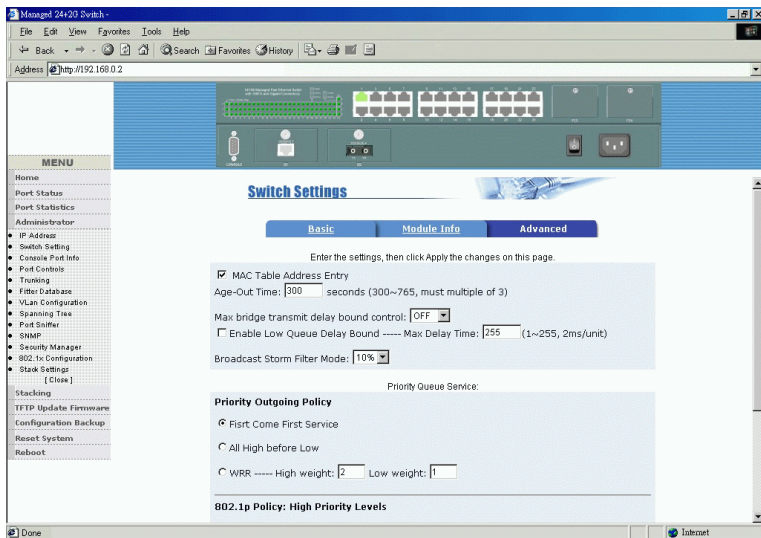

Miscellaneous settings :

MAC Address Age-out Time : Type the number of seconds that an inactive MAC address remains in the switch address table. The valid range is 300~765 seconds (must be multiple of 3). Default is 300 seconds.

Max bridge transmit delay bound control : Limit the packets queuing time in switch. If enabled and queuing time expired, the queued packets will be dropped. Options - OFF (default), 1sec, 2sec, 4sec

Enable Low Queue Delay Bound : setting to limit the low priority packets queuing time in switch. If enabled and queuing time expired, the low priority packets queued in switch will be sent.

Note: Make sure Max bridge transit delay bound control is enabled when Low Queue Delay Bound control is set to ENABLE.

Max. Delay Time : max. low queuing time, value range 1 ~ 255 (2ms/unit)

Broadcast Storm Filter Mode : To configure broadcast storm control, enable it and set the upper threshold applied to all ports. The threshold is the percentage of the port total bandwidth used by broadcast traffic. When broadcast traffic for a port rises above the threshold set, broadcast storm protection becomes active. The valid threshold values are 5%, 10%, 15%, 20%, 25% and Off.

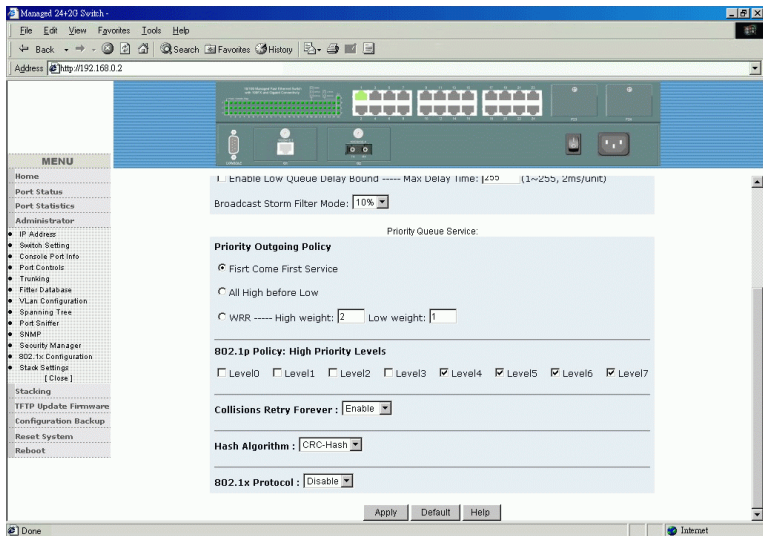

Priority Queue Service settings (select one of the following three modes):
First Come First Service : The sending sequence is based on the order that packets arrived.

All High before Low : The high priority packets sent before low priority packets.

WRR : Weighted Round Robin. Select the ratio preference for high priority packets vs. low priority packets in queues.

802.1p QoS Policy / High Priority Levels : Define each of the possible priority value 0 ~7 in a received tagged packet maps to high or low priority level.

Collision Retry Forever : collision retry mode for half duplex

Disable : retry 48 times for collision situation and drop frames

Enable : retry forever for collision situation

Hash Algorithm : Hash method for MAC address table lookup

CRC-Hash : use CRC-hash method

DirectMap : use MAC address direct map method

802.1x Protocol : enable or disable 802.1X protocol for port-based network access control function. Refer to *Menu* -> *Administrator* -> *802.1x Configuration* for further 802.1x settings.

Click buttons :

[**Apply**] : confirm and apply the settings

[**Default**] : use default values for all settings

5.5.3 Console Port Information

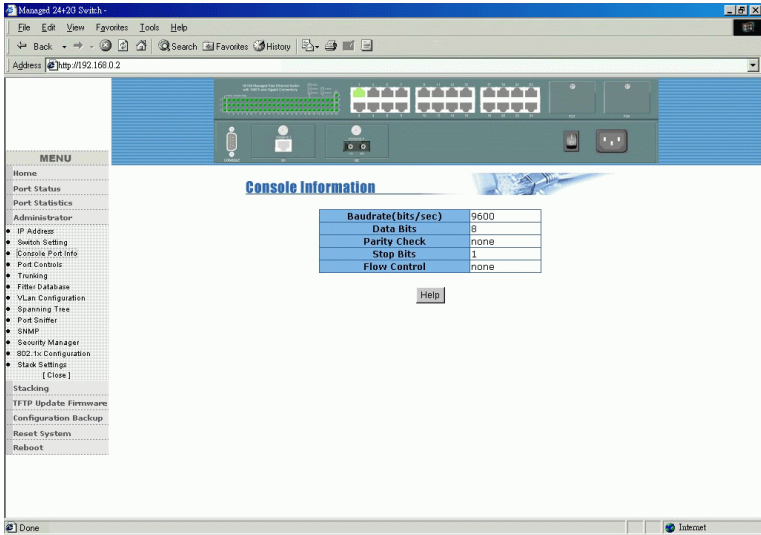

The screenshot shows the web management interface for an HP 2424 Switch. The browser address bar displays 'http://192.168.0.2'. The main content area is titled 'Console Information' and contains a table with the following configuration details:

Baudrate(bits/sec)	9600
Data Bits	8
Parity Check	none
Stop Bits	1
Flow Control	none

A 'Help' button is located below the table. On the left side, a 'MENU' sidebar lists various configuration options, including 'Console Port Info' which is currently selected.

Console port configuration:

Baudrate(bits/sec) : Fixed baud rate - 9600

Data bits : 8

Parity Check : none

Stop Bits : 1

Flow control : none

5.5.4 Port Controls

The screenshot shows the 'Port Controls' configuration page in the Manage24x7 Switch web interface. The interface includes a navigation menu on the left, a top status bar, and two main configuration tables. The top table allows selecting ports (PORT1-4) and setting various parameters like State, Negotiation, Speed, Duplex, Flow Control, Rate Control, Priority, and Security. An 'Apply' button is located below this table. The bottom table displays the current configuration for all ports.

Port	State	Negotiation	Speed	Duplex	Flow Control		Rate Control (100K)		Priority	Security
PORT1					Full	Half	Ingress	Egress		
PORT2	Enable	Auto	100	Full	Enable	Enable	0	0	Disable	<input type="checkbox"/>
PORT3										
PORT4										

Apply

Port	State		Link		Negotiation		Speed		Duplex		Flow Control		Rate Control(100K)		Priority	Security	
	Config	Actual	Config	Actual	Config	Actual	Config	Actual	Config	Actual	Full	Half	Actual	Egr			
PORT1	On	On	Up	Auto	Auto	Auto	100	100	Full	Full	On	On	On	Off	Off	Disable	Off
PORT2	On	On	Down	Auto	Auto	Auto	100	100	Full	Full	On	On	On	Off	Off	Disable	Off

This page allows to change per port configuration settings as follows:

Port : Select the ports to perform setup. More than one port can be selected at the same time for setup.

See next page for control settings.

Note:

All default values displayed for setup are not current setting values, but the factory default values instead. The current values for the selected ports are displayed beneath **[Apply]** button.

Control settings:

State : Disable or enable this port function.

Auto Negotiation : Set auto negotiation mode for this port, options -
Auto = enable auto negotiation with the highest capability
Nway = enable auto negotiation with the specified capability
Force = disable auto negotiation and use forced mode

Speed : Set speed for this port (the highest capability if Auto mode)
Port 1- 24 options : 100, 10
G1, G2 ports options : 1000, 100, 10 (depends on module type)

Duplex : Set duplex mode for the selected port, options -
Full = Full duplex
Half = Half duplex

Flows control/Full : Enable or disable flow control function in full duplex

Flows control/Half : Enable or disable flow control function in half duplex

Rate Control/Ingress : Control ingress data rate (incoming bandwidth)

Rate Control/Egress : Control egress data rate (outgoing bandwidth)
The valid range is 0 ~ 1000. (Unit = 100K), 0 = disable rate control

Port Priority : Port-based priority setting

Options - Disable, High, Low

Port Security : Enable or disable port security mode

Click Button:

[**Apply**] : confirm the changes for the selected ports.

5.5.5 Trunking

The screenshot displays the Management 24x24 Switch web interface. The browser address bar shows `http://192.168.0.2`. The interface features a top navigation bar with tabs for **Aggregator Setting**, **Aggregator Information**, and **State Activity**. The main content area is titled **Trunking** and contains the following configuration fields:

- System Priority:** A text input field containing the value `1`.
- Group ID:** A dropdown menu set to `Group1` with a `<< Get` button to its right.
- Lacp:** A dropdown menu set to `Disable`.
- Work Ports:** A text input field containing `0`, with `<< Add <<` and `Remove >>` buttons below it.
- Work Ports List:** A list box containing `PORT1`, `PORT2`, `PORT3`, `PORT4`, `PORT5`, `PORT6`, `PORT7`, `PORT8`, and `PORT9`.

At the bottom of the configuration area, there are `Apply`, `Delete`, and `Help` buttons. A left-hand **MENU** sidebar lists various system settings, including **Trunking**, **Stacking**, and **System** options.

This page shows settings and status of trunking function. Refer to Chapter 1 for the description of LACP trunking function.

5.5.5.1 Aggregator settings

System Priority : A value used to identify the priority between two active LACP link partners. The switch with the lowest value has the highest priority and is selected as the active LACP.

Group ID : There are seven trunk groups are supported to be configured. Choose the [Group ID] and click [**Get**] to get current settings. Up to 7 groups are supported.

LACP : Enable or disable the group LACP static trunking group. If disabled, the group is local static trunking group and link aggregation is formed without LACP negotiation.

Work ports : Specify the maximal number of ports for link aggregation at the same time for the trunk group. For a static trunk group, four must be specified. For an LACP trunk group, the maximal value is two.

Member ports : Select the ports to join the trunking group. Click [**Add**] to add selected port into member list. Click [**Remove**] to remove the selected member port. Up to four ports can be selected as member ports.

Click Buttons:

[**Apply**] : apply the changes for the selected group ID.

[**Delete**] : delete the selected Group ID

5.5.5.2 Aggregator Information

The following pages illustrate three examples:

No active group configured.

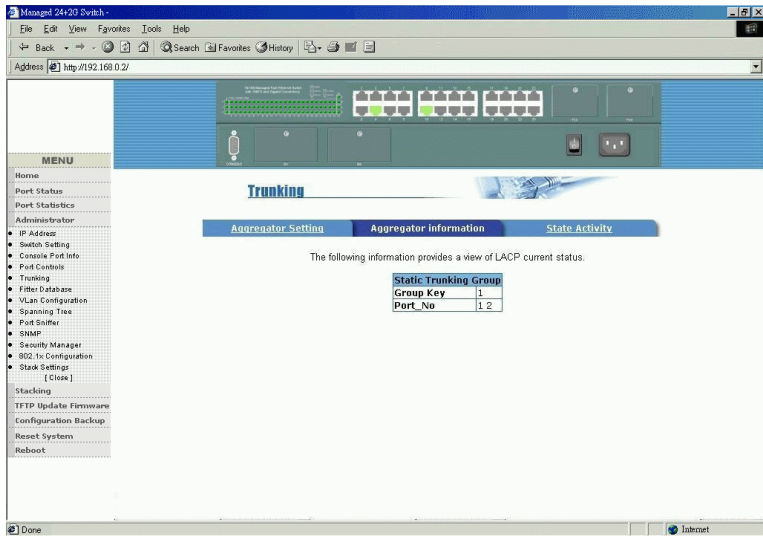

Management 24x24 Switch

File Edit View Favorites Tools Help

Back → Search Favorites History

Address http://192.168.0.2/

Trunking

Aggregator Setting Aggregator Information State Activity

The following information provides a view of LACP current status.

Static Trunking Group	
Group Key	1
Port_No	1, 2

Done Internet

Two Static Trunking groups are configured.

The screenshot shows a web browser window displaying the configuration page for a network switch. The browser's address bar shows the URL `http://192.168.0.2/`. The page title is "Trunking". There are three tabs: "Aggregator Setting", "Aggregator information", and "State Activity". The "Aggregator information" tab is selected. Below the tabs, a text block states: "The following information provides a view of LACP current status." Below this text is a table with the following data:

Actor		Partner				
Priority	1		1			
MAC	0040f6b0000		0040f6b0003			
PortNo	Key	Priority	Active	PortNo	Key	Priority
PORT1	513	1	selected	PORT1	513	1
PORT2	513	1	standby	PORT2	513	1

One LACP trunk group is formed. Trunking information between Actor and Partner are shown.

The following information provides a view of LACP current status.

Group 1							
Actor				Partner			
Priority	1				1		
MAC	0040f6fb0000				0040f6fb0003		
PartNo	Key	Priority	Active	PartNo	Key	Priority	
PORT1	513	1	selected	PORT3	513	1	
PORT2	513	1	selected	PORT1	513	1	
PORT3	513	1	standby	PORT2	513	1	
PORT4	513	1	standby	PORT4	513	1	

5.5.5.3 State Activity

The screenshot shows the HP-Comware Management 24/24 Switch web interface. The browser address bar shows `http://192.168.0.2/`. The page title is "Trunking". Below the title, there are three tabs: "Aggregator Setting", "Aggregator Information", and "State Activity". The "State Activity" tab is selected, displaying a table with the following data:

Port	LACP State Activity	Port	LACP State Activity
1	<input checked="" type="checkbox"/> Active	2	<input checked="" type="checkbox"/> Active
3	N/A	4	N/A
5	N/A	6	N/A
7	N/A	8	N/A
9	N/A	10	N/A
11	N/A	12	N/A
13	N/A	14	N/A
15	N/A	16	N/A
17	N/A	18	N/A
19	N/A	20	N/A
21	N/A	22	N/A
23	N/A	24	N/A
25	N/A	26	N/A

Below the table, there are two buttons: "Apply" and "Help".

Per port LACP mode:

Active (select) : The port can start LACP negotiation with its link partner by sending LACP protocol packet automatically.

Passive (not select) : The port does not send LACP protocol packets automatically and responds only if it receives LACP packets from its link partner.

Click Button:

[**Apply**] : Apply the changes.

5.5.6 Forwarding and Filtering Database

5.5.6.1 IGMP Snooping

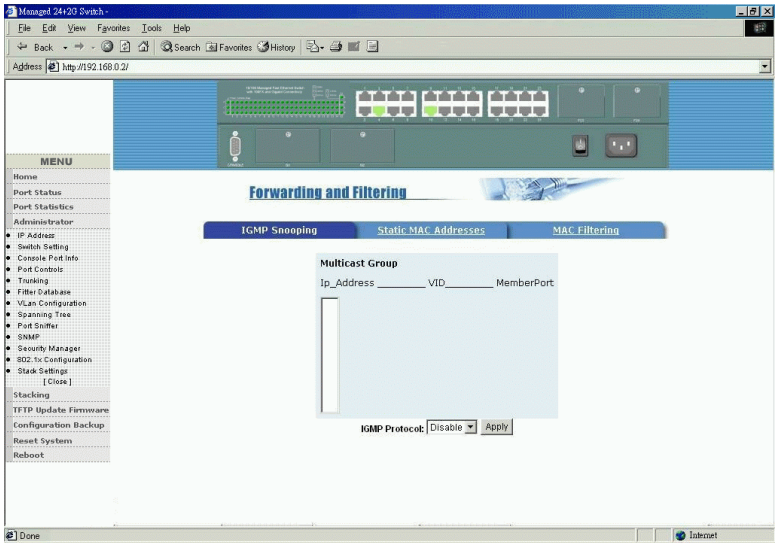

Control setting:

IGMP Protocol : enable IGMP function to collect IP multicast data base and perform IP multicast operation

Multicast Group Information:

This page displays the IGMP snooping information. IP multicast addresses range from 224.0.0.0 through 239.255.255.255.

IP address : IP multicast address (group)

VID : its associated Vlan ID

Member ports : member ports of the group

5.5.6.2 Static MAC Address

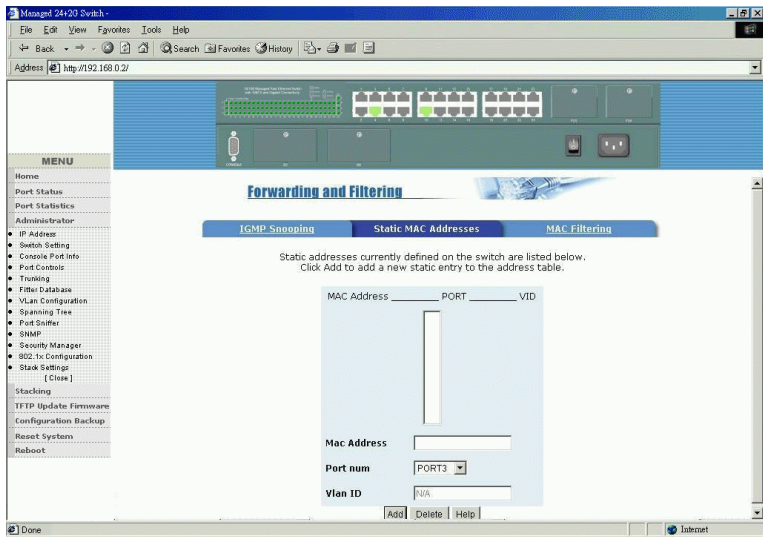

This page is used to maintain Static MAC address data base. Refer to Chapter 1 for the description of Static MAC address function.

Static MAC address related settings:

Mac Address : Static Ethernet MAC address (12 digits)

Port num : The port number where the MAC address is located

Vlan ID : The associated Vlan ID to the address, if 802.1Q VLAN is enabled.

Click Buttons:

[**Add**] : to add the new static MAC address

[**Delete**] : to delete the specified static MAC address

5.5.6.3 MAC Address Filtering

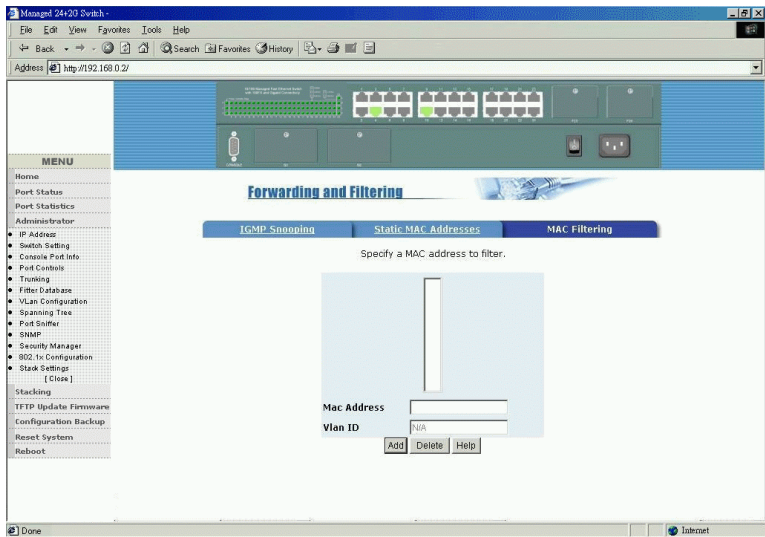

This page is used to maintain filter MAC address table. MAC address filtering allows the switch to drop unwanted traffic. Traffic is filtered based on the destination addresses (DAs). Refer to chapter 1 for the function description.

Filter MAC address settings:

Mac Address : The destination MAC address to be filtered

Vlan ID : The associated Vlan ID to this address, if 802.1Q VLAN is enabled.

Click Buttons:

[**Add**] : to add the new filter MAC address into the filter table

[**Delete**] : to delete the MAC address from the filter table

5.5.7 VLAN configuration

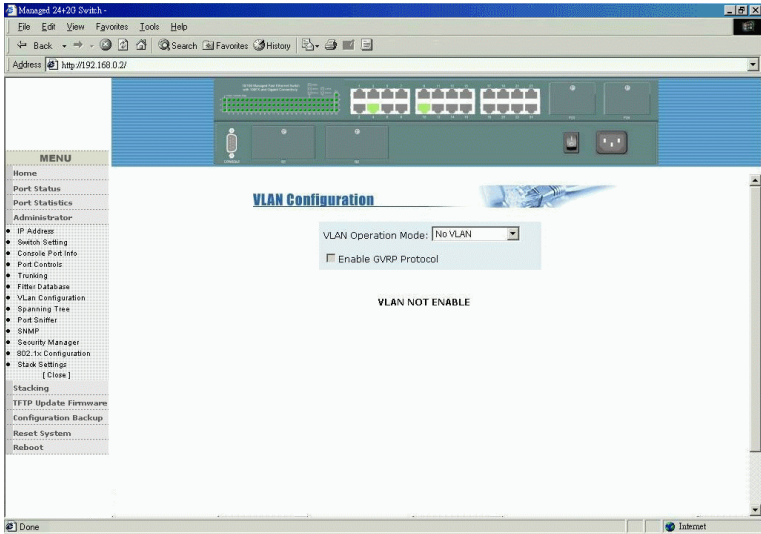

The switch supports port-based, 802.1Q (tag-based) and protocol-based VLAN in this page. In the default configuration, VLAN support is disabled. Refer to Chapter 1 for more description about VLAN function.

VLAN mode selection:

No VLAN - VLAN is disabled

Port Based VLAN

802.1Q - 802.1Q VLAN with Protocol classification option

Note:

Change VLAN mode, you have to reboot the switch for valid value.

5.5.7.1 Port-based VLAN

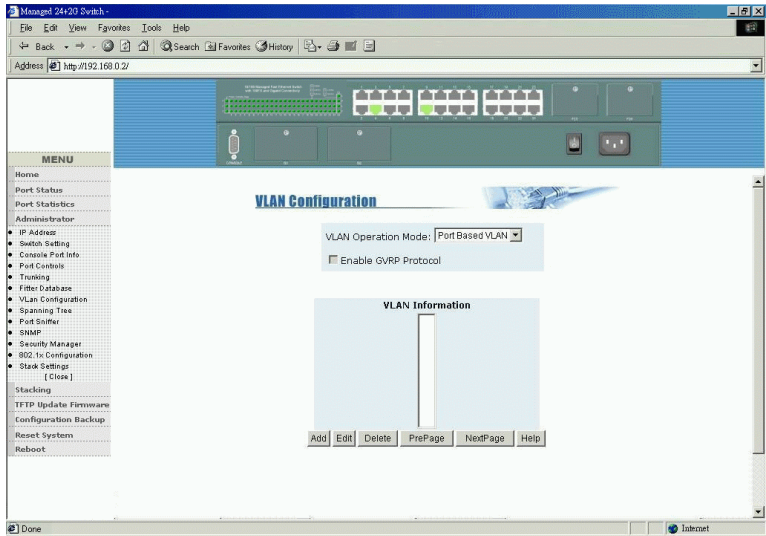

Click:

[Add] : to create a new VLAN group

[Edit] : to edit an existing VLAN group

[Delete] : to delete a VLAN group

[PrPage] : to browse previous group page

[NextPage] : to browse next group page

A Port-based VLAN group contains the following settings:

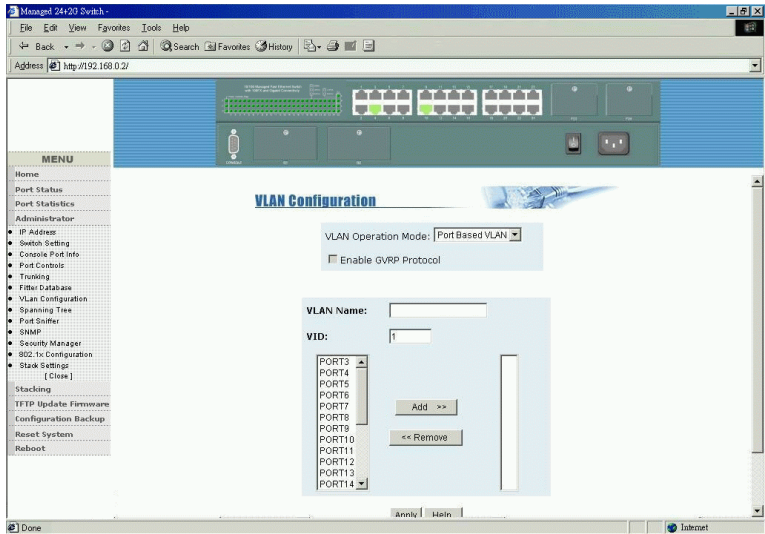

VLAN name : Name of the VLAN group

Group ID : Unique ID for the group

Member ports : list of ports belonging to the group ID

Click [**Apply**] to confirm the changes.

Note:

If the trunk groups exist, you can see it (ex:TRK1,TRK2.....) in select menu of ports, and you can configure it as the member of the VLAN or not.

5.5.7.2 802.1Q VLAN

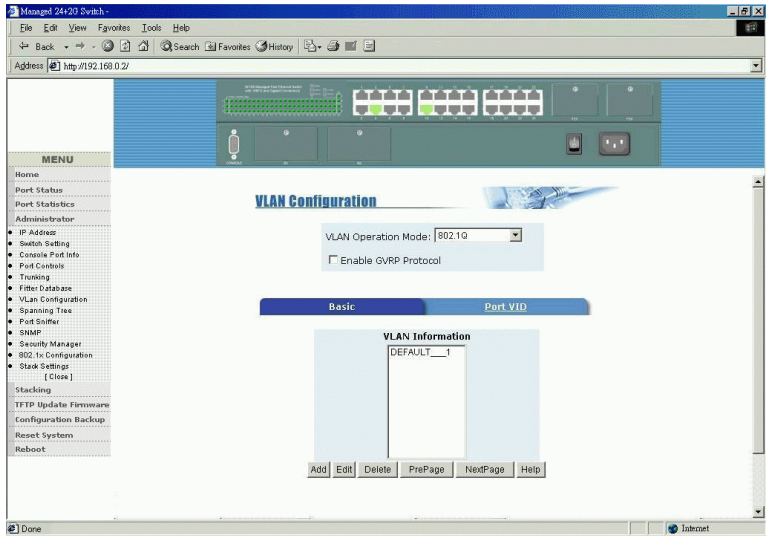

This page is used to display current configured Tag-based VLAN, create a new VLAN, and enable or disable GVRP protocol. Up to 256 VLANs can be configured. When enabling 802.1Q VLAN, all ports on the switch belong to default Vlan ID 1. The default VLAN can not be deleted.

GVRP (GARP VLAN Registration Protocol) support can be enabled for the 802.1Q VLAN mode.

Click Buttons:

[Add] : create a new VLAN

[Edit] : edit an existing VLAN

[Delete] : delete a VLAN

[PrPage] : browse previous VLAN page

[NextPage] : browse next VLAN page

Add a new VLAN

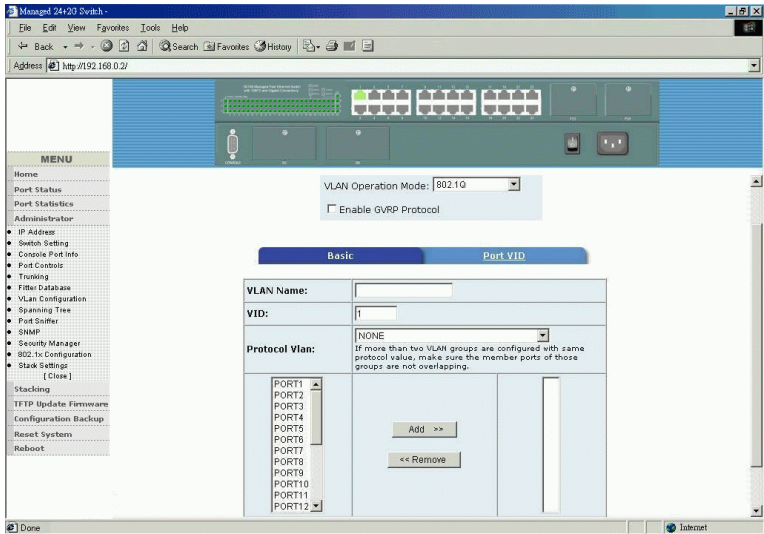

Basic page settings:

VLAN Name : name for the new VLAN

VID : VLAN ID of the new VLAN (value: 2-4094, default: 1)

Protocol Vlan : setting for protocol support as follows:

None

IP, ARP, AppleTalk/NetBIOS

Novell_IPX, Banyan_Vines_C4 / Novell IPX(raw Ethernet)

Banyan_Vines_C5 / Spanning_Tree_Protocol_BPDU

Banyan_Vines_AD / Null_SAP, DECnet_MOP_01

DECnet_MOP_02, DECnet DPR

DECnet_LAT, DECnet_LAVC

IBM_SNA, X.75_Internet, X.25_Layer 3

Edit member ports : select member ports from available port box
[Add] - add one member port
[Remove] - remove a member port

Click [Next] : to set tag/untag mode for the member ports

Note:

If more than two VLAN groups are configured with same protocol value, make sure the member ports of those groups are not overlapping.

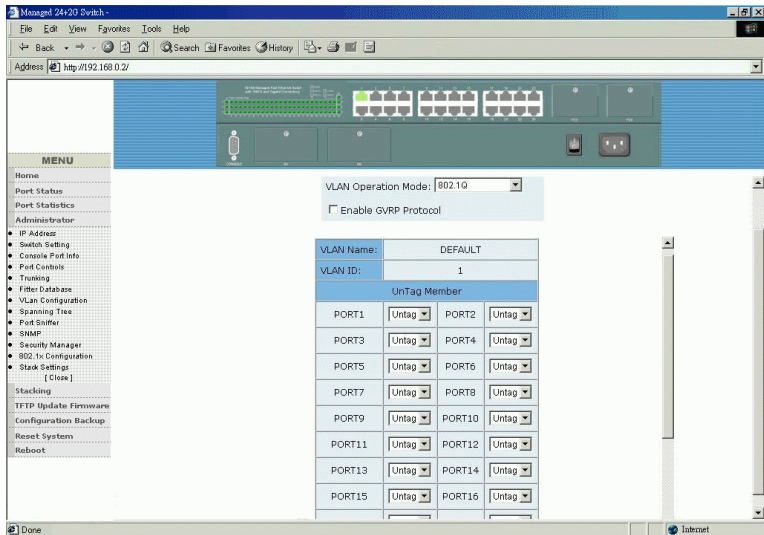

Tag : outgoing frames with VLAN-Tagged.

Untag : outgoing frames without VLAN-Tagged.

Port VID Settings

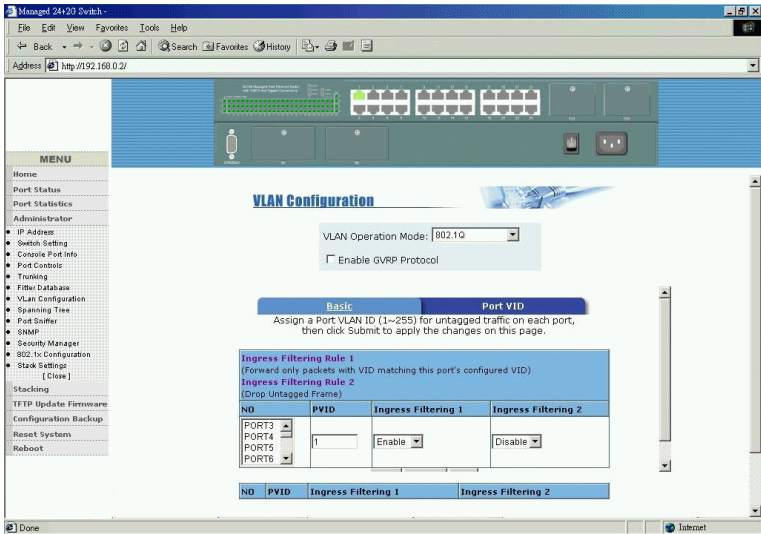

Click [**Port VID**] to set per port VID and Ingress filtering rules. Multiple port selection at the same time for same settings is allowed.

Port VID Settings:

Port VID (PVID) : the port VLAN ID that will be assigned to untagged traffic on a given port. The range is 1~255, default PVID is 1.

Ingress Filtering Rule 1 : Drop or forward input VLAN tagged frames whose VID does not match PVID associated to the input port. This rule is applied only when input port is not the member port of the associated VLAN group.

Ingress Filtering Rule 2 : Drop Untagged Frame.

5.5.8 Spanning Tree

This page shows an example of STP Root Bridge information of the switch.

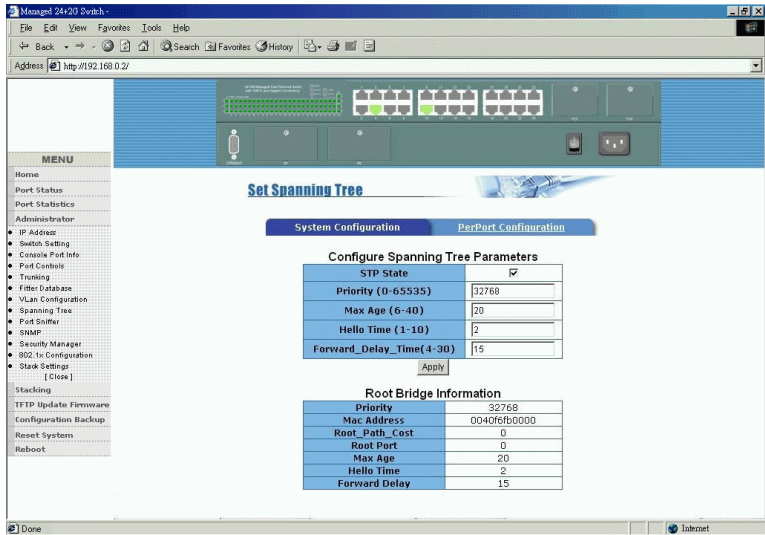

The screenshot displays a web browser window with the address `http://192.168.0.2/`. The page title is "Set Spanning Tree". The interface includes a left-hand menu with options like "Home", "Port Status", "Port Statistics", "Administrator", "IP Address", "Switch Setting", "Console Port Info", "Port Console", "Trunking", "Filter Database", "VLAN Configuration", "Spanning Tree", "Port Sniffer", "SNMP", "Security Manager", "802.1x Configuration", "Stack Settings", "Stacking", "FTP Update Firmware", "Configuration Backup", "Reset System", and "Reboot".

The main content area has two tabs: "System Configuration" (selected) and "PerPort Configuration". Under "System Configuration", there are two tables:

Configure Spanning Tree Parameters

STP State	
STP State	<input checked="" type="checkbox"/>
Priority (0-65535)	32768
Max Age (6-40)	20
Hello Time (1-10)	2
Forward_Delay_Time(4-30)	15

Apply

Root Bridge Information

Priority	32768
Mac Address	0040f6fb0000
Root_Path_Cost	0
Root Port	0
Max Age	20
Hello Time	2
Forward Delay	15

This page shows an example of STP port status

Configure Spanning Tree Port Parameters

Port Number	Path Cost (1 - 65535; Default 10)	Priority (0 - 255; Default 128)
PORT3		
PORT4		
PORT5	10	128
PORT6		
PORT7		

Apply Help

STP Port Status

PortNum	PathCost	Priority	PortState
PORT3	10	128	FORWARDING
PORT4	10	128	FORWARDING
PORT5	10	128	FORWARDING
PORT6	10	128	FORWARDING
PORT7	10	128	FORWARDING
PORT8	10	128	FORWARDING
PORT9	10	128	FORWARDING

Refer to Chapter 1 for the description of Spanning Tree Protocol.

STP parameters settings:

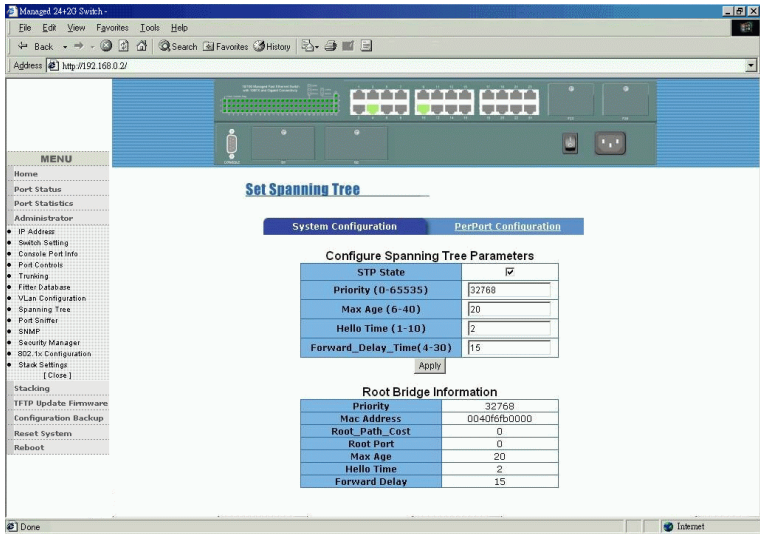

STP State : Enable or disable STP function

Priority : A value used to identify the root bridge. The bridge with the lowest value has the highest priority and is selected as the root. Valid values : 1 through 65535.

Max Age : The number of seconds a bridge waits without receiving Spanning-Tree Protocol configuration messages before attempting a reconfiguration. Valid values : 6 ~ 40

Hello Time : The number of seconds between the transmission of Spanning-Tree Protocol configuration messages. Valid values : 1 ~ 10

Forward Delay time : The number of seconds a port waits before changing from its Spanning-Tree Protocol learning and listening states to the forwarding state. Valid values : 4 ~ 30

Refer to Chapter 1 for STP Parameter Descriptions.

STP port parameters settings:

The screenshot shows the Manage! 2420 Switch web interface. The main content area is titled "Set Spanning Tree" and contains a "Configure Spanning Tree Port Parameters" form. The form has two columns: "Path Cost (1 - 65535; Default 10)" and "Priority (0 - 255; Default 128)". The "Port Number" column has a dropdown menu with options PORT3, PORT4, PORT5, PORT6, and PORT7. The "Path Cost" and "Priority" columns have input fields with values 10 and 128 respectively. Below the form are "Apply" and "Help" buttons. Below the form is a table titled "STP Port Status" with columns "PortNum", "PathCost", "Priority", and "PortState".

PortNum	PathCost	Priority	PortState
PORT3	10	128	FORWARDING
PORT4	10	128	FORWARDING
PORT5	10	128	FORWARDING
PORT6	10	128	FORWARDING
PORT7	10	128	FORWARDING
PORT8	10	128	FORWARDING
PORT9	10	128	FORWARDING

Port Priority : Priority value for becoming the root port. The range is 0-255, default setting is 128, the lowest number has the highest priority.

Path Cost : Specifies the path cost of the port that switch uses to determine which port are the forwarding ports the lowest number is forwarding ports, the range is 1-65535 and default value base on IEEE802.1D
10Mb/s = 50-60 100Mb/s = 10-60 1000Mb/s = 3-10

STP port status:

Port State : Forwarding, Blocking, Listening, Learning

Refer to Chapter 1 for STP Per Port Parameter and status Description.

5.5.9 Port Sniffer

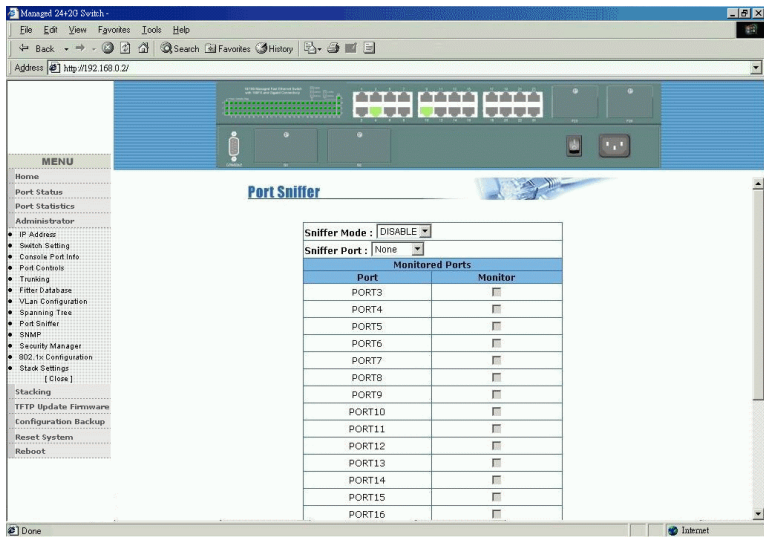

Sniffer Mode : Select one of sniffer modes, options -

DISABLE : Disable sniffer function

RX : All Rx traffic on monitored ports are copied to Analysis port

TX : All Tx traffic on monitored ports are copied to Analysis port

BOTH : Both Rx and Tx traffic are copied to Analysis port

Sniffer Port : The port can be used to see all monitored port traffic. It can connect to a LAN analyzer or netxray. Select **None** when sniffer function is disabled.

Monitored Ports : Select monitored ports

Refer to Chapter 1 for description of Port Sniffer function.

5.5.10 SNMP

SNMP Parameters

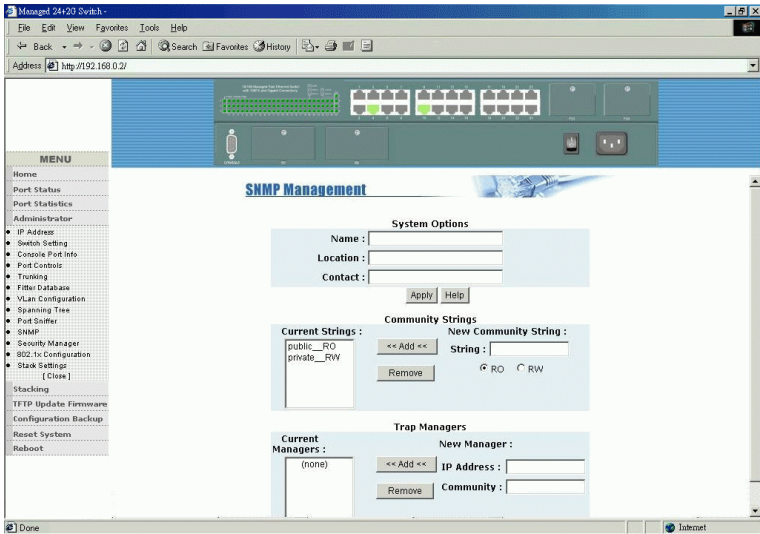

This page is used to configure SNMP related parameters as follows:

Name : Name to be used for the switch.

Location : The location of the switch.

Contact : A name of a person or organization

Click [**Apply**] to apply the settings.

SNMP Managers

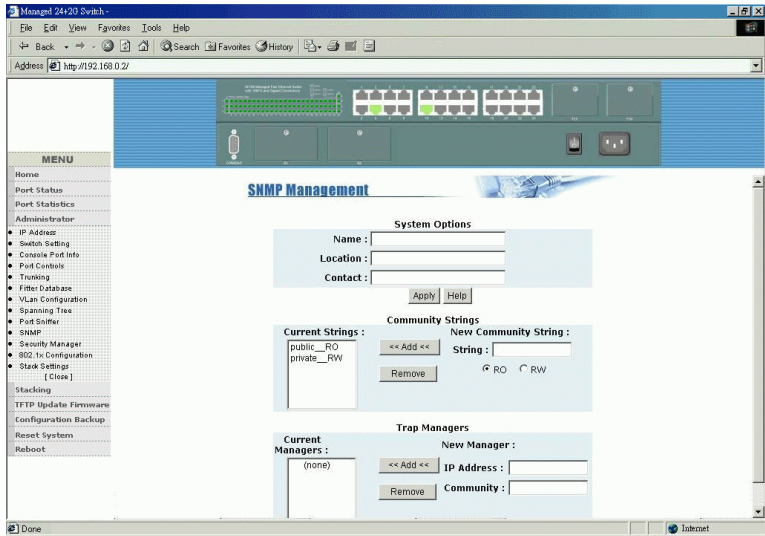

Community String and access control settings:

Community String : The community string serves as a password which allows remote SNMP manager stations to access the switch management objects via SNMP protocol. Max. Up to 4 community strings are supported.

RO : Access right for **Read Only** is associated to the community string

RW : Access right for **Read Write** is associated to the community string

Click Buttons:

[Add] : Add the specified community string

[Remove] : Delete the selected community string

SNMP Trap Managers

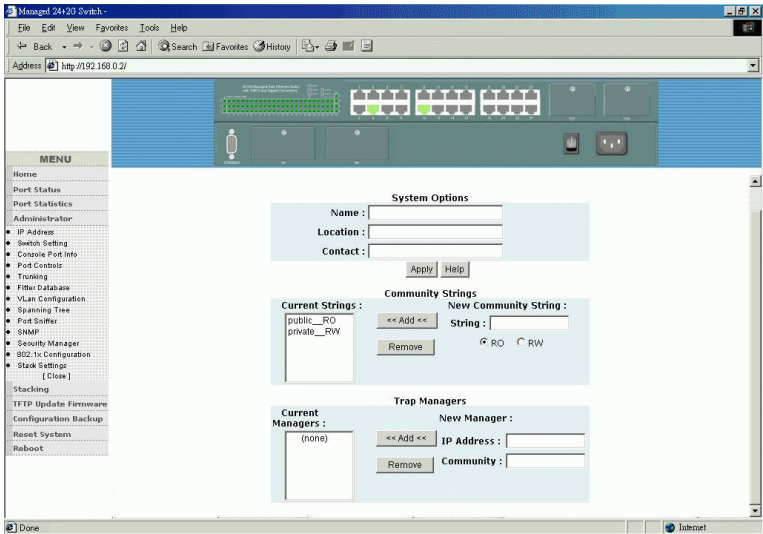

A trap manager is a management station which can receive SNMP trap messages sent by the switch when predefined trap events occur.

SNMP Trap Manager settings:

IP address : IP address of the trap manager station

Community : Community string belonging to the trap manager

Click Buttons:

[**Add**] to add a new trap manager

[**Remove**] to delete a trap manager

Max. Up to 3 trap managers are supported.

5.5.11 Security Manager

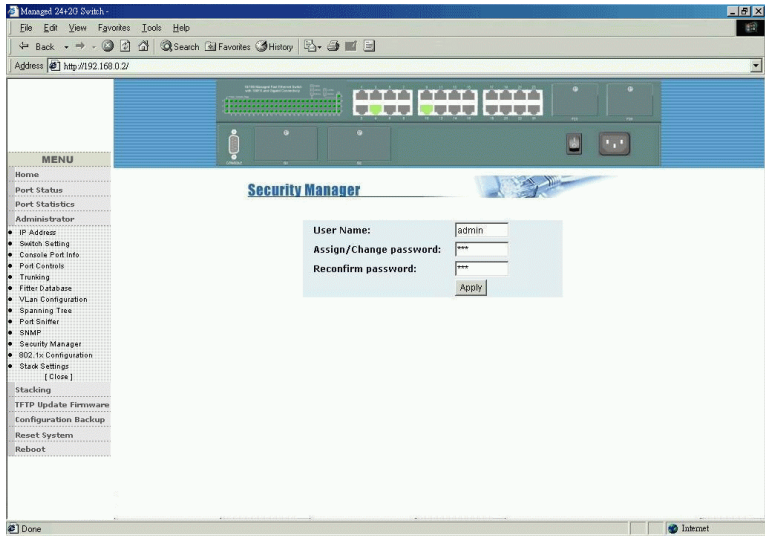

This page is used to configure the user who is allowed to access the switch via direct console, telnet and web management interfaces.

User name : Type the new user name

Assign/Change password : Type the new password

Reconfirm password : Retype the new password

Click [**Apply**] to apply the changes.

5.5.12 802.1X Configuration

The screenshot shows the Mikrotik WinBox interface for configuring 802.1X parameters. The browser address bar shows `http://192.168.0.2/`. The main content area is titled "802.1X Configuration" and has three tabs: "System Configuration", "PerPort Configuration", and "Misc Configuration". The "System Configuration" tab is selected, showing a table for "Configure 802.1X Parameters".

Configure 802.1X Parameters	
Radius Server IP :	192.168.221.72
Server Port :	1812
Accounting Port :	1813
Shared Key :	12345678
NAS_Identifier :	NAS_L2_SWITCH

Below the table are "Apply" and "Help" buttons. A left-hand menu is visible with various system configuration options.

This menu includes three 802.1X function related settings:

System Configuration : Parameters for connection to a Radius server

PerPort Configuration : Per port 802.1X mode settings

Misc Configuration : 802.1X protocol related timers and parameters

System Configuration

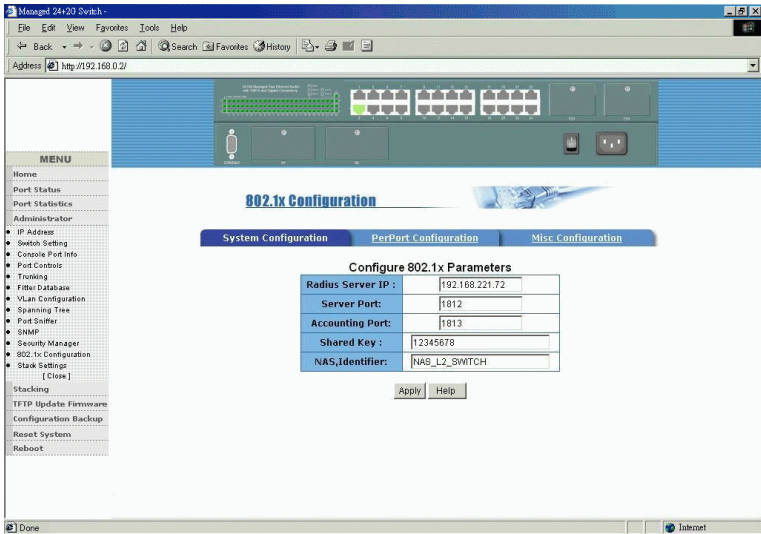

Radius Server IP : IP address of the Radius server

Server Port : the UDP destination port for authentication requests to the specified Radius server

Accounting Port : the UDP destination port for accounting requests to the specified Radius server

Shared Key : an encryption key for use during authentication sessions with the specified Radius server. It must match the key used on the Radius server.

NAS Identifier : identifier for this Radius client (this switch)

Click [**Apply**] to apply the changes.

5.5.12.1 802.1X PerPort Configuration

The screenshot shows the web interface for configuring 802.1X per port settings. The main configuration table is as follows:

Port Number	Port State
PORT1	Au
PORT2	
PORT3	
PORT4	
PORT5	

Below the configuration table is a 'Port Status' table:

PortNum	State
PORT1	No
PORT2	No
PORT3	No
PORT4	No
PORT5	No
PORT6	No
PORT7	No
PORT8	No

This page is used to set per port 802.1x authorization state mode. The options are:

Au (Auto) - The port is set to the Authorized or Unauthorized state in accordance with the outcome of an authentication exchange between the Supplicant and the Authentication Server.

Fa (Forced Authorized) - The port is forced to be in authorized state.

Fu (Forced Unauthorized) - The port is forced to be in unauthorized state.

No (None) - The port is not necessary authorized.

Click [**Apply**] to apply the changes.

5.5.12.2 802.1X Misc Configuration

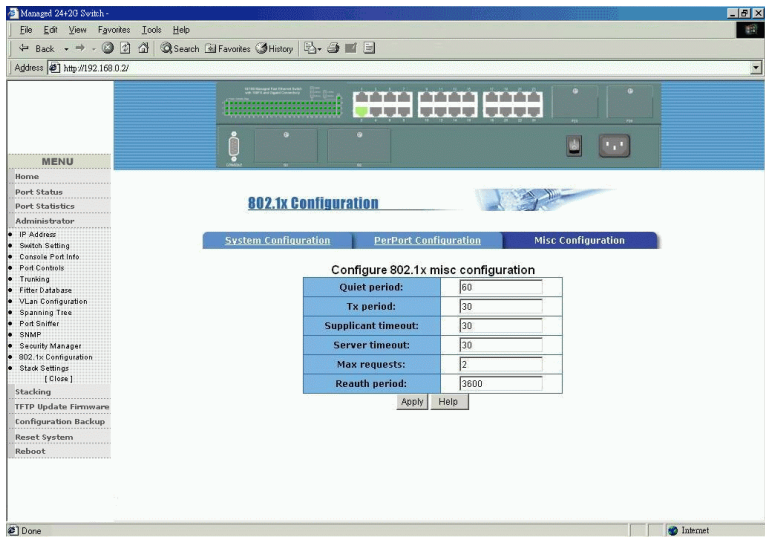

This page is used to setup 802.1x protocol timers and parameters:

Quiet period - the period during which the port does not try to acquire a supplicant (unit: second)

Tx period - the period the port waits to retransmit the NEXT EAPOL PDU during an authentication session (unit: second)

Supplicant timeout - the period of time the switch waits for a supplicant response to an EAP request (unit: second)

Server timeout - the period of time the switch waits for a server response to an authentication request (unit: second)

Max requests - the number of authentication attempts that must time-out before authentication fails and the authentication session ends.

Reauth period - the period of time after which the connected radius clients must be re-authenticated (unit: second)

Click [**Apply**] to apply the changes.

5.5.13 Stack Settings

The screenshot shows the Cisco Management 24493 Switch web interface. The browser address bar shows `http://192.168.0.2`. The page title is "Stack Setup".

The configuration area includes the following fields:

- Stack Name: Stack 1
- Master Name (Unit 1): Unit 1

Member Unit No.	Name	IP address	Username	Password
2	Unit 2	192.168.0.28	admin	***
3	Unit 3	192.168.0.216	admin	***
4				
5				
6				
7				
8				

Buttons: Apply, Reset, New

The switch supports stack management feature. More than one of the switches can be grouped together as a switch stack. As the stack is configured, all switches in stack can be managed from the master unit easily without memorizing many IP addresses and tedious login procedures. Up to 16 switch units can be configured as a switch stack.

This page is used to configure a stack information in this master unit. The configuration includes:

Stack Name - Give a name to this stack

Master Name - Give a name to the master unit of the stack. The name is used for identifying each unit in a stack easily.

Configure other members in the stack:

Member Unit No. - the sequence number of each member unit

Name - Give an identified name to the member unit

IP address - The IP address of the member unit

Username - The login username of the member unit

Password - The password of the member unit

Click [**Apply**] to confirm the setup for member unit #2 to unit #8.

Click [**Reset**] to clear all settings of the stack.

Click [**Next**] to switch to next configuration page for member unit #9 to unit #16. The setup is same as this page.

All information is stored in the master switch for stack management. To enter stack management, click [**Stacking**] in main menu. Refer to next section for stack management operation.

Note:

If the setup information of a member unit is incorrect, the associated unit will not be able to be connected and managed.

5.6 Stacking

Click [**Stacking**] in main menu to enter into switch stack management for up to 16 units. No more than one IP address, login procedures are required for multiple switch management. The following figure illustrates a stack composed of three units.

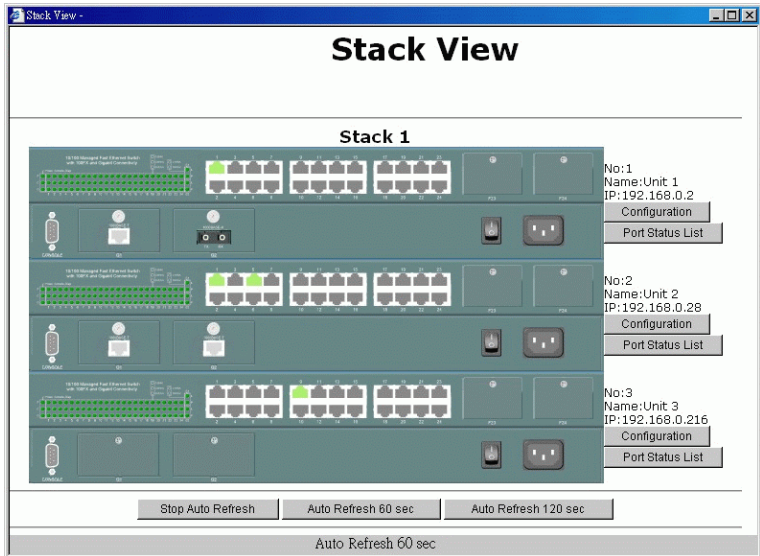

This page shows the following information:

- Stack name displayed on top of the stack
- Switch port status of all units presented by graphical switch images
- The sequence number of the unit
- The configured name of the unit
- The IP address of the unit

When more than three units are in the stack, use scroll bar to browse the other units.

Besides showing information, two buttons are provided next each switch image. They are used for further management operations as follows.

[Configuration] : enter full web management home page of the unit

[Port Status List] : show detailed port configuration and status of the unit by a table list. Refer to section 5.3 for status explanation.

The port status showing in the switch images are refreshed automatically with a default period of 60 seconds. Three options are provided at the bottom of the stack image as follows:

[Stop Auto Refresh] : Disable auto refresh

[Auto Refresh 60 sec] : Auto refresh period of 60 seconds

[Auto Refresh 120 sec] : Auto refresh period of 120 seconds

Note:

If any of the IP, username and password information of one member unit is incorrect, the associated switch image will not be displayed. One disconnected blank page is displayed instead.

Close Stack View window to exit stack management.

5.7 TFTP Update Firmware

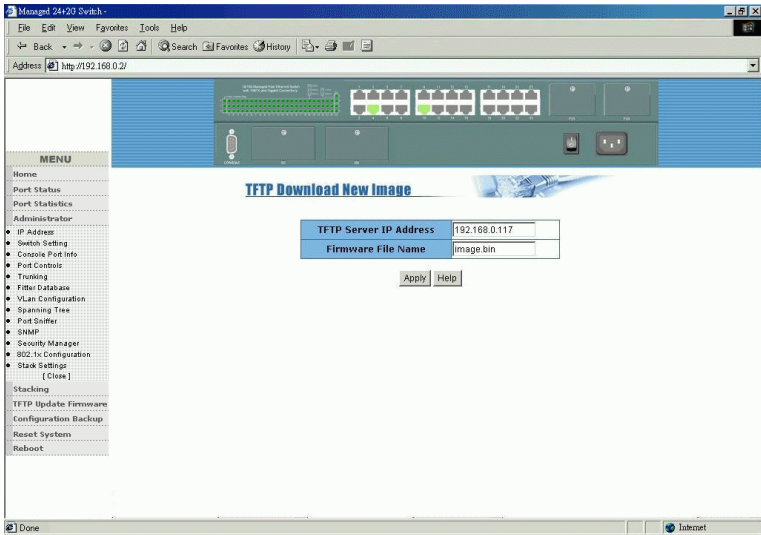

The steps to update the firmware of the switch are:

1. Start your TFTP server.
2. Copy the firmware image file of new version into the TFTP server.
3. In this web page, specify the **IP address** of the TFTP server, in where the new firmware image file is stored.
4. In this page, specify **Firmware File Name** of the new image file.
5. Click [**Apply**] to start the download operation.

---- continued ----

6. Click [**Update Firmware**] in following download complete message to confirm the update.

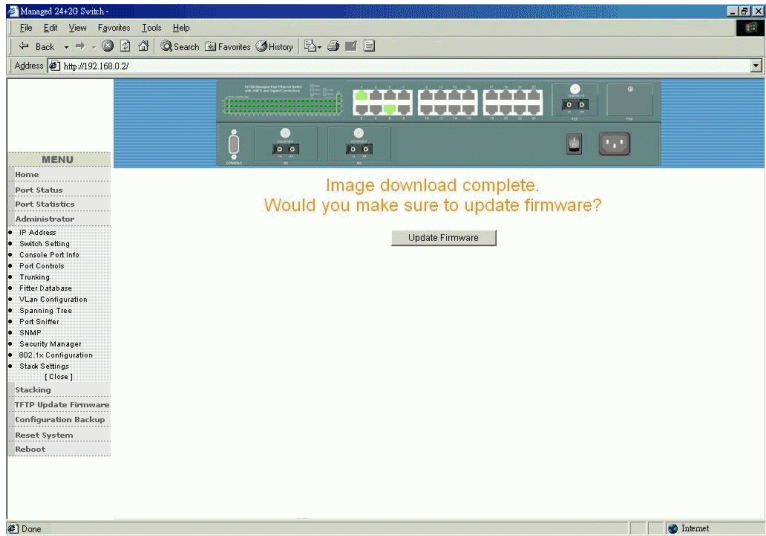

7. Reboot the system

5.8 Configuration Backup

5.8.1 TFTP Restore Configuration

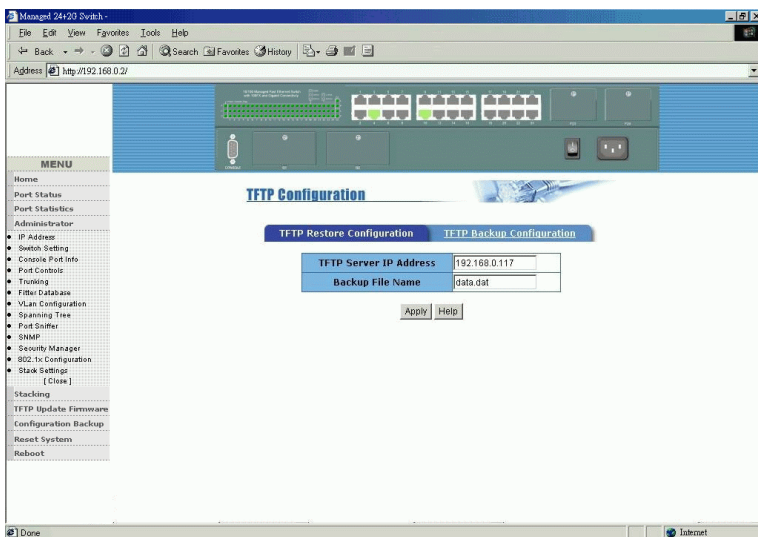

The function is used to download a new default configuration file from a TFTP server into the switch. The steps are:

1. Start your TFTP server.
2. Copy the new default configuration file into the TFTP server.
3. In this web page, specify the **IP address** of the TFTP server, in where the new default configuration file is stored.
4. Specify **Backup File Name** of the new configuration file.
5. Click [**Apply**] to start the download operation.
6. Reset the system to use the new default configuration data.

5.8.2 TFTP Backup Configuration

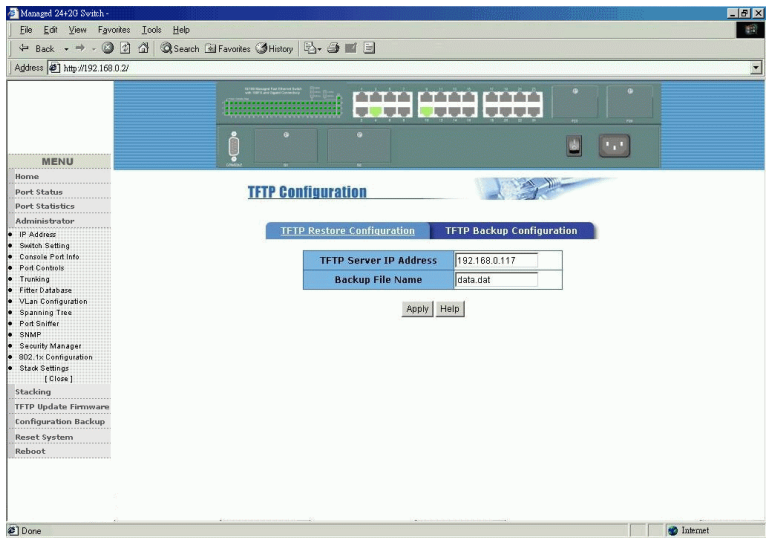

This function is used to backup (upload) current configuration settings of the switch unit onto a TFTP server. The steps are:

1. Start your TFTP server.
2. In this web page, specify the **IP address** of the TFTP server, to where the current configuration data is saved.
3. Specify **Backup File Name** of the configuration file to be saved.
4. Click [**Apply**] to start the upload operation.

5.9 Reset System

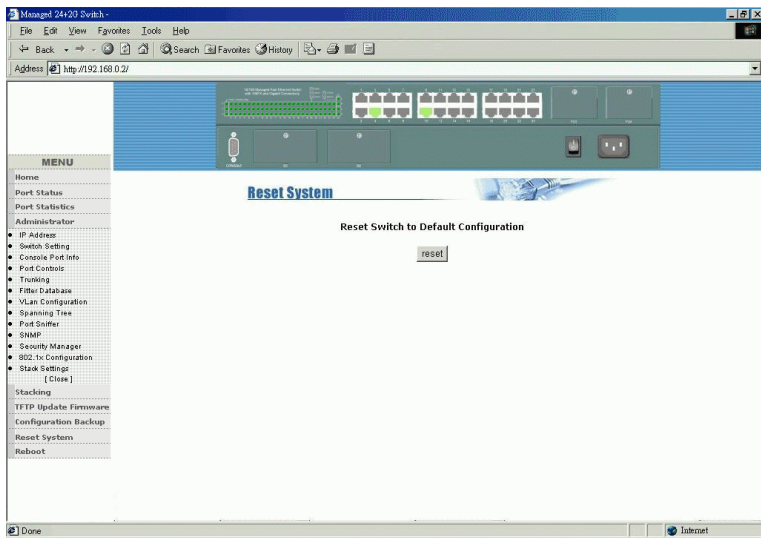

This function is used to reset the switch with *default configuration* data.

Click [**Reset**] to start the operation.

5.10 Reboot

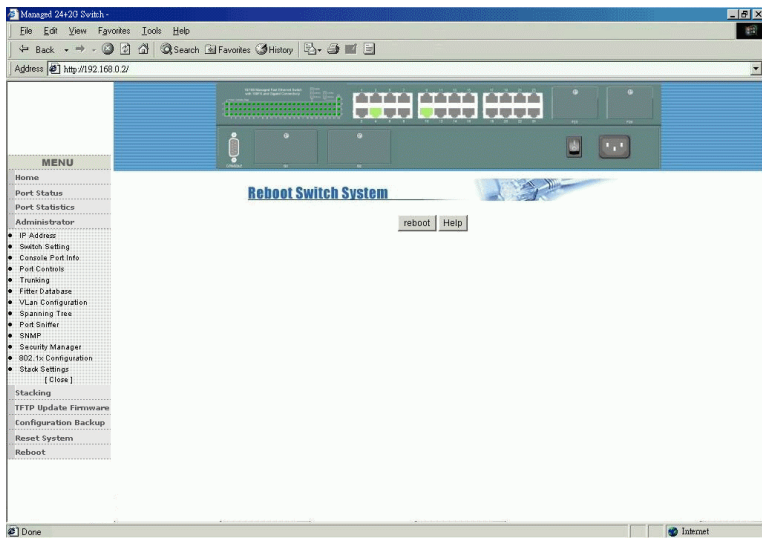

This function is used to reboot the switch with *current configuration* settings.

Click [**Reboot**] to start operation.

6. Update Firmware from Console

The switch also supports firmware update from console port. The operation is performed over 1K Xmodem protocol.

Cases to update firmware from console:

1. Power on the switch and press any key from console within 5 seconds. The switch enters 1K Xmodem receiver mode.
2. The switch enters 1K Xmodem receiver mode automatically when it detects firmware checksum error while booting.

Setup 1K Xmodem on Hyper Terminal

1. Press [**Disconnect**] to stop Hyper Terminal.
2. 1K Xmodem only works on 57600 baudrate. Enter *File -> Property* to set COM port for baudrate 57600, 8 data bit, None parity, 1 stop bit, No flow control.
3. Press [**Connect**] to reconnect to the switch.
4. Enter *Transfer -> Send File* command.
5. Specify the file name of the firmware image file.
6. Specify 1K Xmodem protocol.
7. Click [**Send**] button to start file transfer.

When finishing downloading image, the switch will update firmware automatically and reboot. Change COM port baudrate back to to 9600bps.

Appendix A: Factory Default Settings

IP Address Related Settings

DHCP	Disabled
Static IP Address	192.168.0.2
Subnet Mask	255.255.255.0
Default Gateway	192.168.0.1

Per Port Settings

Port Function	Enabled
Auto-negotiation	Auto
Speed	100Mbps (Port 1-Port 24) 1000Mbps (Port G1, G2)
Duplex	Full (All ports)
Flow Control / Full	Enabled
Flow Control / Half	Enabled
Ingress Rate Control	0 - Off
Egress Rate Control	0 - Off
Port Security	Off

Switch Unit Related Settings

User Name	Admin
Password	123
Age-out Time	300 seconds
Max. Bridge Transmit Delay Bound	Off
Enable Low Queue Delay Bound	Off
Max. Low Queue Delay Bound	255 (2ms/unit)
Broadcast Storm Filtering	25%
Collision Retry Forever	Disabled
Hash Method	CRC-Hash
802.1x Protocol	Enabled
Trunking	No trunk group
IGMP	Enabled
Static MAC Address	None
Filter MAC Address	None
Port Sniffer Function	Disabled

QoS Priority Settings

Port Priority	Disabled (All ports)
802.1p Priority Level	Low priority for Level 0~3 High priority for Level 4-7
Priority Queue Service Mode	All High before Low

VLAN Settings

VLAN Mode	No VLAN
Port-based VLAN	No group (if enabled)
802.1Q VLAN	GVRP enabled
802.1Q VLAN Groups	All ports in VID=1 Vlan Name=Default Tag rule = Untag for all member ports PVID = 1, Protocol type : None Ingress Filtering Rule 1 : enabled Ingress Filtering Rule 2 : disabled

Spanning Tree Protocol Settings

STP Function	Disabled
Bridge Priority	32768
Bridge Max. Age	20
Hello Time	2
Forward Delay Time	15
STP Port Priority	128 (All ports)
STP Port Path Cost	10 (All ports)

SNMP Related Settings

System Name	Null
System Location	Null
System Contact	Null
Community String 1	String = public, Access right = RO
Community String 2	String = private, Access right = RW
Community String 3 & 4	Not available

SNMP Trap Manager Settings

Trap Manager 1	Not available
Trap Manager 2	Not available
Trap Manager 3	Not available

802.1X Function Settings

802.1X Protocol	Disabled
Radius Server IP	192.168.0.59
Shared Key	12345678
NAS Identifier	NAS_L2_SWITCH
Server Port	1812
Accounting Port	1813
Port 802.1x mode	None (no control) for all ports
Quiet Period	60 seconds
Tx Period	30 seconds
Supplicant Timeout	30 seconds
Server Timeout	30 seconds
Max Requests	2 times
ReAuth Period	3600 seconds