



# **Modular Media Converter Center System**

KC-1300

## **Operation Manual**



DOC.180125B-KC1300

(C) 2018 KTI Networks Inc. All rights reserved. No part of this documentation may be reproduced in any form or by any means or used to make any directive work (such as translation or transformation) without permission from KTI Networks Inc.

KTI Networks Inc. reserves the right to revise this documentation and to make changes in content from time to time without obligation on the part of KTI Networks Inc. to provide notification of such revision or change.

For more information, contact:

**United States**

KTI Networks Inc.  
P.O. BOX 631008  
Houston, Texas 77263-1008

Phone: 713-2663891  
Fax: 713-2663893  
E-mail: [kti@ktinet.com](mailto:kti@ktinet.com)  
URL: <http://www.ktinet.com/>

**International**

Fax: 886-2-26983873  
E-mail: [kti@ktinet.com.tw](mailto:kti@ktinet.com.tw)  
URL: <http://www.ktinet.com.tw/>

The information contained in this document is subject to change without prior notice.  
Copyright (C) KTI. All Rights Reserved.

## TRADEMARKS

Ethernet is a registered trademark of Xerox Corp.

## WARNING:

This equipment has been tested and found to comply with the limits for a Class A digital device, pursuant to Part 15 of the FCC Rules. These limits are designed to provide reasonable protection against harmful interference when the equipment is operated in a commercial environment. This equipment generates, uses, and can radiate radio frequency energy and if not installed and used in accordance with the instruction manual may cause harmful interference in which case the user will be required to correct the interference at his own expense.

## NOTICE:

- (1) The changes or modifications not expressly approved by the party responsible for compliance could void the user's authority to operate the equipment.
- (2) Shielded interface cables and AC power cord, if any, must be used in order to comply with the emission limits.

## CE NOTICE

Marking by the symbol indicates compliance of this equipment to the directives of the European Community. Such marking is indicative that this equipment meets or exceeds the following technical standards:

EMC Directive 2014/30/EU

EN 55032 Class A

CISPR 32

EN 61000-3-2, EN 61000-3-3

EN 55024

IEC 61000-4-2, IEC 61000-4-3, IEC 61000-4-4, IEC 61000-4-5

IEC 61000-4-6, IEC 61000-4-8, IEC 61000-4-11

LVD Safety Directive 2014/35/EU

EN 60950-1, IEC 60950-1

## VCCI NOTICE

この装置は、クラスA情報技術装置です。この装置を家庭環境で使用すると電波妨害を引き起こすことがあります。この場合には使用者が適切な対策を講ずるよう要求されることがあります。

VCCI-A

# Table of Contents

<b>1. Introduction .....</b>	<b>6</b>
1.1 Features .....	7
1.2 Technical Specifications .....	8
<b>2. Installation .....</b>	<b>12</b>
2.1 Unpacking .....	12
2.2 System Units .....	12
2.2.1 Management Module .....	14
2.2.2 Power Chassis Modules .....	16
2.3 Rack Mounting .....	22
<b>3. Network Management .....</b>	<b>23</b>
3.1 Management Functions .....	23
3.2 Protocols Supported .....	24
3.3 Setup for Out-of-band (Console) Management .....	25
3.4 Setup for In-band Management .....	27
<b>4. Console and Telnet Operation .....</b>	<b>28</b>
4.1 IP Menu .....	32
4.2 SNMP Menu .....	33
4.3 View System Status .....	34
4.4 View Converter Slots Status .....	35
4.5 Restore Default Values .....	37
4.6 Security Manager .....	38
4.7 Update Firmware .....	39
4.8 Reboot System .....	40
<b>5. SNMP Management .....</b>	<b>41</b>
5.1 Configuring SNMP Settings via Console Operation .....	42
5.2 SNMP Private MIB .....	43
5.3 SNMP Traps .....	44
<b>6. Web Management .....</b>	<b>45</b>
6.1 Start Browser Software and Making Connection .....	45
6.2 Login to the System Unit .....	46
6.3 Converter Status .....	48
6.4 System Status .....	50
6.5 Administrator Menu .....	51

6.5.1 Basic .....	52
6.5.2 Console Port Information .....	57
6.5.3 Security Manager .....	58
6.5.4 Image Refresh Time .....	59
6.5.5 Update Firmware .....	60
6.5.6 Reboot System .....	61
6.6 Slot Icon Operations .....	62

# 1. Introduction

---

The Modular Converter System KC-1300 is a managed media converter rack that provides 16 slots and hosts 16 units of Media Converter (MC). A wide range of media converters are available depending on your variety of network cabling environment. These optional media converters include Gigabit and Fast Ethernet copper to multimode or single mode fiber cable.

The rack unit provides a centered power supply to the converter modules and serves as a converter center and wiring concentrator.

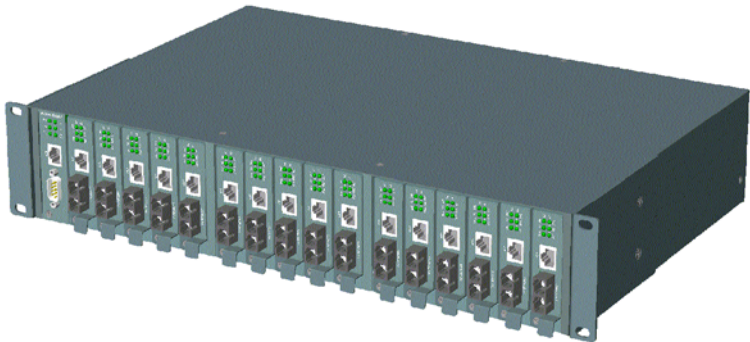

For specifications of media converter KC-300D, KC-300DM, KGC-300, KGC-311 and KGC-310M-C, refer to the associated installation guides respectively.

## 1.1 Features

Some of the key features include:

- Managed Media Converter Center Rack
- 19-inch rack-mountable 2U chassis
- Managed system accommodates up to 16 media converters
- Highly modularized chassis design with
  - modular media converters
  - modular management module
  - two system power modules for power redundancy
- Provides high availability and maintainability
- Power backup feature with two power chassis
- Visible system status indication
- Supports in-band Telnet, SNMP and web-based management
- Supports out-of-band direct console management
- Management from anywhere and any platform using a web browser
- Easy-to-use point and click user interface
- Photographic quality interface to configure and monitor the system
- Supports in-band event SNMP trap report
- Photographic quality interface to configure and monitor the system
- TFTP Software Upgrade

## 1.2 Technical Specifications

<b>System Model</b>	<b>KC-1300L/1A</b>	<b>KC-1300L/2A</b>	<b>KC-1300/1A</b>	<b>KC-1300/2A</b>
Management support	Unmanaged	Unmanaged	Managed	Managed
Plug-in power modules	1 AC	2 AC	1 AC	2 AC
Input voltage	100~240V	100~240V	100~240V	100~240V
Power supply rating	70W	70W	70W	70W
Weight (no MC installed)	5.5Kg	6.2Kg	5.5Kg	6.2Kg
<b>System Model</b>	<b>KC-1300L/1D</b>	<b>KC-1300L/2D</b>	<b>KC-1300/1D</b>	<b>KC-1300/2D</b>
Management support	Unmanaged	Unmanaged	Managed	Managed
Plug-in power modules	1 DC	2 DC	1 DC	2 DC
Input voltage	+/-48VDC	+/-48VDC	+/-48VDC	+/-48VDC
Power supply rating	75W	75W	75W	75W
Weight (no MC installed)	5.5Kg	6.2Kg	5.5Kg	6.2Kg

### Common Specifications

19-inch rack mount	Yes
Number of MC slots	16 slots
Number of power slots	2
Cooling	1 DC Fan
Dimension	H 88mm (2U) x W 443mm x D 300mm
Load Bearing	60kg

### Environmental

Operating temperature	-5~40°C
Storage temperature	-20~80°C
Operating humidity	5~90%RH

### Emission standard

	N55032, CISPR 32 Class A
Voltage harmonics	EN61000-3-2
Voltage fluctuation & flicker	EN61000-3-3

### Susceptibility

	EN55024
Electrostatic discharge immunity	IEC61000-4-2
Radiated immunity	IEC61000-4-3
EFT/Burst immunity	IEC61000-4-4
Surge immunity	IEC61000-4-5
Continuous wave voltage immunity	IEC61000-4-6
PFMF immunity	IEC61000-4-8
Voltage DIP/Interrupt immunity	IEC61000-4-11

### Certifications

FCC	Part 15, Class A
CE	EMC Class A, LVD EN60950-1
VCCI	V-2 Class A



### **AC Power Chassis Module Specifications**

Dimension	194mm x 156mm x 40.3mm
Installation method	Plug in from system rear panel
Maintenance	Modular design for easy maintenance
AC power switch	System power on/off switch
AC power receptacle	IEC320 type receptacle
Power status indicator	Green LED
Electric	
Input voltage rating	100 ~ 240VAC
Input frequency	47 ~ 63Hz
Input surge current	20A max. @115VAC
Efficiency	75% @115VAC full load
Output power	70W
Power Module Safety	UL/cUL, TUV EN60950
Insulation Resistance	>10M Ohm @DC500V
Dielectric withstands	1500VAC 10mA 1min.
Protection	Over voltage, over power, short circuit
Safety	IEC60950-1

### **DC Power Chassis Module Specifications**

Dimension	194mm x 156mm x 40.3mm
Installation method	Plug in from system rear panel
Maintenance	Modular design for easy maintenance
DC power switch	System power on/off switch
DC power receptacle	Screw type terminal block
Power status indicator	Green LED
Electric	
Input voltage rating	+/-48VDC
Input voltage range	+48VDC(+/-10%), -48VDC(+/-10%)
Efficiency	73% typ. at full load
Output power	75W
Safety	EN60601-1, IEC60601-1

## Management Module Specifications

Dimension	107mm x 24mm x 86.4mm
Slot position	Slot 0
CPU	RISC-based ARM7
RAM size	2M bytes
Flash size	512K bytes

### System interface

Connector	FutureBus
-----------	-----------

### Console interface

Interface	RS-232 DTE
Connector	9-pin male D-SUB connector
Baud rate	38400, N, 8, 1, 0
Flow control	Disabled

### In-band interface

Interface	10/100M LAN port
Connector	Shielded RJ-45 MDI
Standard	IEEE 802.3 10BASE-T/100BASE-TX
Auto-negotiation	Support

### LED Indicators

P1, P2	Green LED, power module status
DIAG	Green LED, CPU initialization
FAN	Green LED, Fan failure indication
CONSOLE	Green LED, Console RS-232 Rx activities
LNK/ACT.	Green LED, LAN port link and activities status

## Management Specifications

### Management interface

Telnet	Via direct RS-232 console connection
Telnet	Via TCP/IP Telnet software
SNMP agent	Via TCP/IP SNMP manager software
HTTP server	Via web browser software

### Protocols

IPv4	IP version4	RFC791
TCP	Transmission Control Protocol	RFC793
UDP	User Datagram Protocol	RFC768
ICMP	Internet Control Message Protocol	RFC792
SNMP	SNMP agent v1	RFC1157
MIB-II	Standard MIB	RFC1213
TFTP	Trivial File Transfer Protocol	RFC1350
TELNET	Telnet protocol	RFC854
HTTP	HTTP server for web management	RFC1945

### Management Objects

Password for access control	Set and monitor
System status : CPU, memory, flash, software	Monitor

System power 1&2 status	Monitor
System fan status	Monitor
IP address of the system	Set and monitor
Subnet mask of the system	Set and monitor
Default gateway IP address	Set and monitor
SNMP name information	Set and monitor
SNMP location information	Set and monitor
SNMP contact information	Set and monitor
SNMP community names (up to 4)	Set and monitor
SNMP community access right (up to 4)	Set and monitor
SNMP trap host IP address (up to 3)	Set and monitor
Slot status : MC installed or not	Monitor
MC status : media type, speed, duplex	Monitor
MC link status of two ports	Monitor
Remote MC link status (*)	Monitor

#### **SNMP Traps**

Cold Start	System is powered on and completes initialization
Authentication failure	SNMP community authentication failure
Power status	The system power 1&2 failure and recovery
Fan failure	System fan failure and recovery
Slot # Port A link	Slot # MC Port A link down or up
Slot # Port B link	Slot # MC Port B link down or up
Slot # RTP link	Slot # Remote MC TP port link change
	Via TFTP protocol

#### **Update Firmware**

#### **Remote boot system**

\* MC models which support Remote MC link status: KC-300DM, KGC-310M, KGC-310M-B and KGC-310M-C.

## 2. Installation

---

### 2.1 Unpacking

The product package contains:

- The system unit
- One 19-inch rack mounting kit
- One RS-232 cable
- One power cord (AC models only)

### 2.2 System Units

The figure below illustrates the front view of the KC-1300 system:

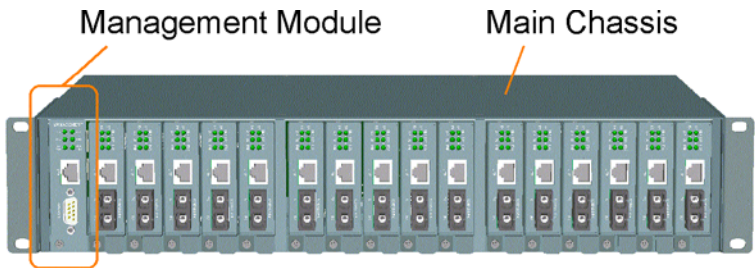

Depending on the model purchased, the type and numbers of the pre-installed media converters may be different. The figure shows a system which is fully installed with media converters.

The following figures show the rear view of the KC-1300 system. The main chassis provides two power chassis slots on the rear panel. Each power chassis slot can be installed with one AC power chassis. Two power slots design features the system a power redundant function.

The following figure shows the model equipped with two AC power chassis.

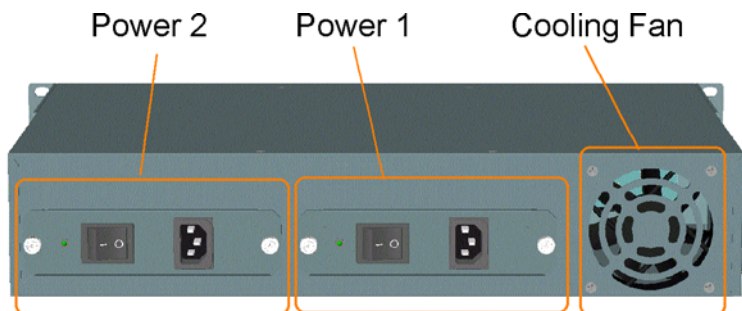

**Main Chassis :** provides insertion slots on front panel for CPU management module and optional add-on media converters. It also provides two chassis slots on rear for mounting power chassis modules.

**Management Module :** serves as a management agent to monitor system status and add-on converter modules for in-band and out-of-band management requests.

**Power Chassis :** provides full centered power supply for whole system unit. It can receive commercial AC power with AC power chassis and +48VDC or -48VDC power with DC power chassis.

**System Cooling Fan :** provides forced air to cool down the temperature for the system unit.

## 2.2.1 Management Module

The system unit comes with one pre-installed Management module. The module facilitates the following functions:

- Direct out-of-band management via RS-232 console port
- SNMP agent to serve in-band management via SNMP protocol
- Telnet console in-band management via TCP/IP protocol
- HTTP host to serve web-based in-band management
- Monitoring all MCs status installed in the system
- Monitoring system power and fan status

See figure below for major components on the panel:

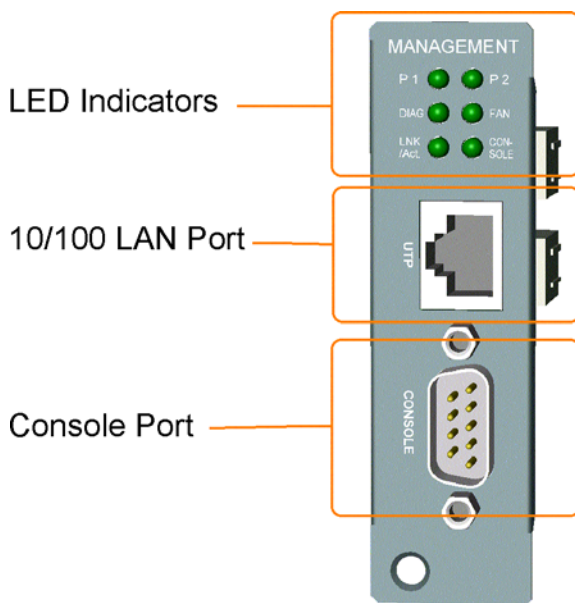

## Console Port

This port is a 9-pin male D-sub connector. It serves as an RS-232 DTE port. Refer to Chapter xx for the console operation. The pin definitions are:

Pin 2	RXD
Pin 3	TXD
Pin 4	DTR
Pin 5	GND
Pin 6	DSR

## UTP Port

This is an auto-negotiation 10/100BASE-TX LAN port and provides a shielded RJ-45 jack with MDI definition. This port must connect to your TCP/IP network for all in-band management operations.

LED Indicators	Color	States	Interpretation
P1	Green	On	Power 1 module is ON
P2	Green	On	Power 2 module is ON
DIAG	Green	On	CPU initialization
		Off	Initialization complete
FAN	Green	On	Fan failure detected
		Off	Fan in normal operation
CONSOLE	Green	On	Rx activities of console port
LNK/ACT	Green	On	LAN port link is active
		Blink	Tx/Rx activities of UTP port

## 2.2.2 Power Chassis Modules

The system power supply is assembled in a plug-in chassis module as shown below:



Each single power module is capable to supply full power for system operation with media converters fully installed.

### AC Power Chassis Specifications (KC1300-AC)

AC power switch	System power on/off switch
AC power receptacle	IEC320 type receptacle
Input voltage range	90 ~ 264VAC
Input frequency	47 ~ 63Hz
Output power	70W
AC power cord	IEC320 type power cord
Power status display	Green LED

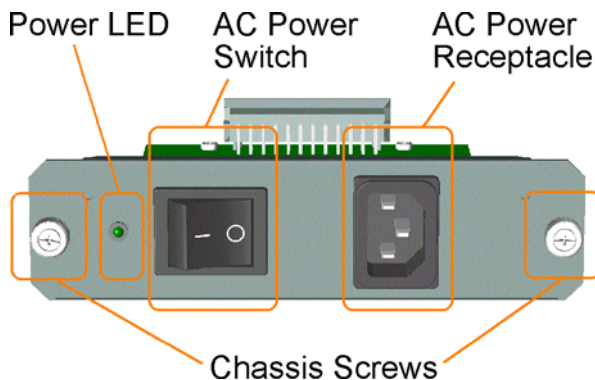



### DC Power Chassis Specifications (KC1300-DC)

Input power switch	System power on/off switch
Input power receptacle	Terminal connector (screw type)
Input voltage rating	+/-48VDC
Input voltage range	+48VDC(+/-10%), -48VDC(+/-10%)
Output power	75W
Power status display	Green LED

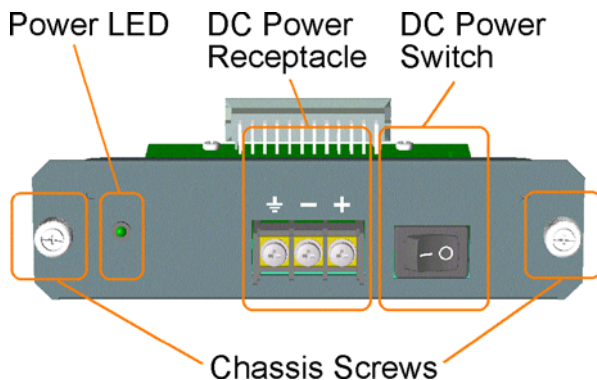

## Removal of System Power Chassis

The system power chassis is pre-installed in the system unit when system unit is shipped from factory. The chassis is designed for easy un-installation from system unit in case of any inspection purpose. However, note that this removal only can be performed by a well-trained technical person.

For safety reason before removing the power chassis, make sure:

- The power switch is turned off.
- The power cord is disconnected from the power chassis.

To remove the chassis, unscrew two chassis screws until they are released from system chassis, hold the handle and pull the chassis out from the system chassis smoothly. See the following example figure:

1. Unscrew

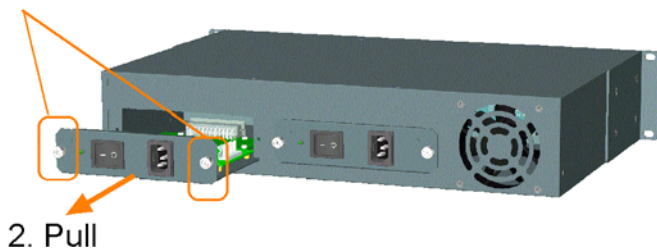

2. Pull

## Insertion of System Power Chassis

Before inserting the power chassis into system unit, make sure:

- The system power switch is turned off.
- The power cord is disconnected from the power chassis.

To insert the power chassis, hold the handle and push it into system unit until it is seated in system chassis properly. Screw the chassis securely in the system unit. See figure below:

### 2. Screw



### 1. Insert

The power chassis is designed to be hot plugged into or unplugged from the system even when another power chassis is installed in another power slot and in operation.

### 2.2.3 Media Converter Slots

The system chassis provides sixteen slots for installing optional slide-in MCs.

A media converter can be inserted into an available slot or removed from a slot anytime even when system unit is powered on. This hot-plug design keeps all exiting connections on the other slots running with no influence.

To insert an MC into a slot, the steps are:

1. Install a bracket, which is provided in the rack chassis package onto the MC unit as shown below:



2. Remove slot cover first and insert the MC into slot slowly until it is seated in slot properly.
3. Screw the bracket onto system chassis securely before making any cable connection.

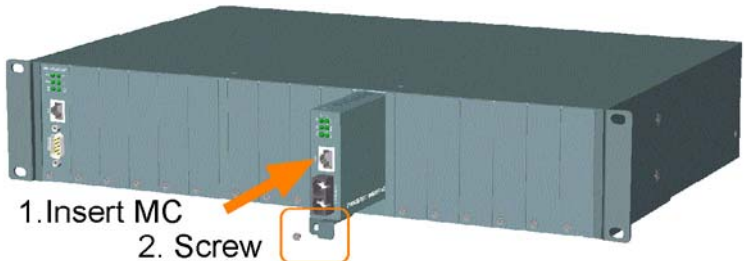

To remove an MC from slot, the steps are:

1. Disconnect all cable connections on the MC first.
2. Unscrew the MC bracket from system chassis.
3. Hold the bracket and pull it slowly out from the slot.

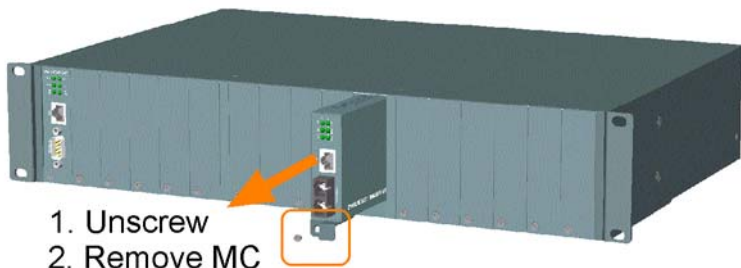

The media converters are designed with hot-plug feature, which allows insertion and removal of the converters can be performed even when the system is in operation.

## 2.3 Rack Mounting

One rack mounting kit is supplied in the product package. It includes two rack mounting brackets and screws for installing the system unit into a 19-inch rack.

Mount both brackets onto the system unit as shown below:

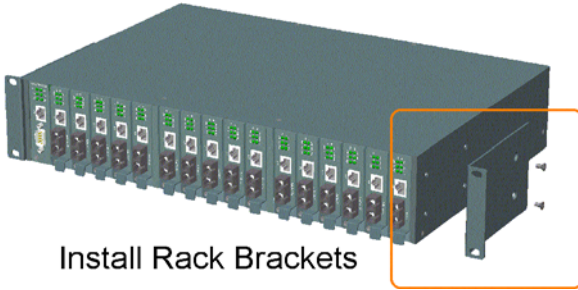

Install the system unit into a 19-inch rack as shown below:



## 3. Network Management

---

### 3.1 Management Functions

The managed converter rack system series is featured with management functions and can be managed by using the following methods:

- Direct console connection over an RS-232 cable
- Telnet software over TCP/IP network
- SNMP manager software over TCP/IP network
- Web browser software from Internet or Intranet over TCP/IP network

#### Management Interface RS-232 / Protocol

Console operation	RS-232 console port
Console operation	Telnet over TCP/IP
SNMP management	SNMP over TCP/IP
Web browser	HTTP over TCP/IP

The following figure illustrates a management model diagram:

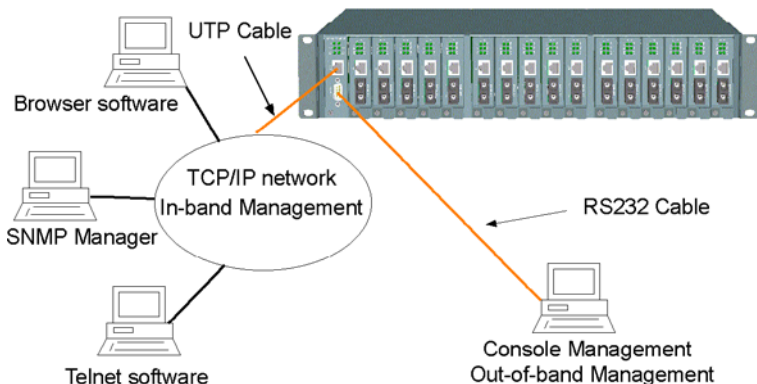

The system unit is equipped with one management module which serves as a management agent to monitor the system status and all installed media converter modules. The agent also responds to either in-band management requests coming from network or out-of-band requests from directly connected console.

## 3.2 Protocols Supported

<b>Protocols</b>	<b>Name</b>	<b>Reference</b>
IPv4	IP version4	RFC791
TCP	Transmission Control Protocol	RFC793
UDP	User Datagram Protocol	RFC768
ICMP	Internet Control Message Protocol	RFC792
SNMP	SNMP agent v1	RFC1157
MIB-II	Standard MIB	RFC1213
TFTP	Trivial File Transfer Protocol	RFC1350
TELNET	Telnet protocol	RFC854
HTTP	HTTP server for web management	RFC1945



### 3.3 Setup for Out-of-band (Console) Management

Before doing any in-band management, it is necessary to perform console operation for configuring IP and SNMP related settings for the first time the system is received for installation. The console port is located on the SNMP module.

Any PC running Windows can be used as a console via COM port. Windows Hyper Terminal program is an ideal and the most popular software for such console terminal operations.

To setup console operation, the steps are:

1. Find a proper RS-232 cable for the connection to a console terminal.  
If your are using PC as a terminal, make sure the cable pin assignments comply to the following requirement.

Console port			9-pin PC COM port	
Pin 2	RXD	-----		3
3	TXD	-----		2
4	DTR	-----		6
5	GND	-----		5
6	DSR	-----		4



2. Connect one end to the console port and connect the other end to the PC COM port.
3. Configure your PC COM port setting to match the RS-232 settings of the console port and start your terminal software.

**Factory default settings of the Console port**

Baud rate : 38400, N, 8, 1, 0

Flow control : disabled

4. Turn the system power on.
5. Press <Enter> key several times in your terminal software until a login prompt comes up. It means the connection is proper.

The console port does not support modem connection.

Refer to Chapter 4 for more information about Console management.

### 3.4 Setup for In-band Management

To perform an in-band management, it is necessary to connect the system to your TCP/IP network. The steps are:

1. Configure IP and SNMP related settings to the system using direct console management when you receive it first time for the installation.
2. Find a proper straight-through Category 5 UTP cable (maximal length 100 meters) for the connection.
3. Connect one end of the UTP cable to the UTP port on SNMP module and connect the other end to the device, such as a switching hub, in your TCP/IP network.

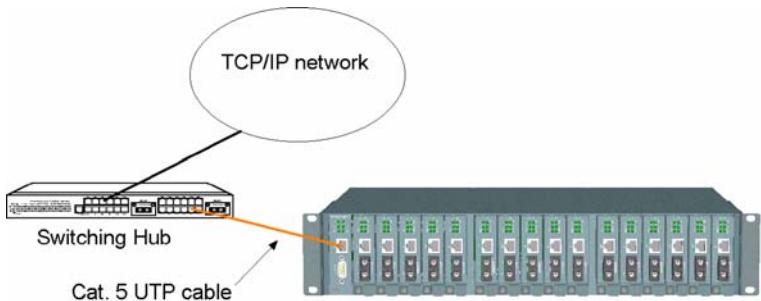

4. Start your in-band management operations. For different management methods, refer to:
  - Chapter 4 for Telnet management
  - Chapter 5 for SNMP management
  - Chapter 6 for Web management

## 4. Console and Telnet Operation

---

### Functions supported:

- Set and display IP parameters for the system.
- Set and display SNMP parameters for the SNMP agent function.
- Monitor system power status, power temperature status, system fan status and other system information.
- Monitor installation status of each slots.
- Monitor the configuration and link status of each MC installed.
- Restore default settings for the system
- Change administrator password for access control.
- Update system software.
- Reboot (warm start) the system remotely.

<b>Management Objects</b>	<b>Modify</b>	<b>Monitor</b>
Password for access control	Y	-
System : CPU, memory, flash, software version	-	Y
Power 1&2 status	-	Y
System fan status	-	Y
IP address of the system	Y	Y
Subnet mask of the system	Y	Y
Default gateway IP address	Y	Y
SNMP name	Y	Y
SNMP location	Y	Y
SNMP contact	Y	Y
SNMP community name (up to 4)	Y	Y
SNMP community access right (up to 4)	Y	Y
SNMP trap host IP address (up to 3)	Y	Y
Slot status : module installed or not	-	Y
MC status : media type, speed, duplex	-	Y
MC link status of two ports	-	Y
Remote MC TP link status *	-	Y

\* Remote MC TP link status monitoring is available only when KC-300DM in the rack is connected to a remote KC-300DM through fiber link.

## Cold Start

When the power to the system is turned on, the system start initialization and self-test process. The self-test messages are displayed as follows if a console connection is established successfully.:

## Power-on Self-test

```
-----  
$$$ System LOADER Checksum O.K !!!  
$$$ System IMAGE Checksum O.K !!!  
$$$ System DATA Checksum O.K !!!  
$$ Waiting Copy Rom to Sdram  
$$$ System Power On Self Test....  
$$$ ARM Reg R/W Test Success !!!  
$$$ System EEPROM Checksum O.K !!  
$$$ Get parameter O.K !!  
My Mac Address is xxxxxxxxxxxxxx  
-----
```

This chapter describes the detailed console operation. It can be applied to either out-of-band console management or in-band Telnet management. Both are same in operation starting from login prompt.

## Direct Console Management

When you can see the self-test messages shown on screen properly, you can press <Enter> key to start console login operation. Go to **Login Prompt** section in next page directly.

## Telnet Management

Use Telnet software to perform the management operation. The most convenient solution is using the built-in Telnet function in a Windows 95/98/ or NT PC. Enter into DOS window and invoke Telnet command :

```
>telnet xxx.xxx.xxx.xxx
```

to connect to the system unit. The specified xxx.xxx.xxx.xxx is the IP address of the system unit. A welcome message and login prompt are displayed if the connection is established properly.

## Login Prompt

The following figure illustrates the login screen:

```
-----  
Welcome to Console  
login:admin  
password:***  
-----
```

```
Username: admin  
Factory default Password: 123
```

For security reason, the system supports a function to change the password in setup menu. It is recommended to change the default password immediately after a successful login.

When login successfully, a Setup menu is shown as follows:

```
-----  
Setup Menu  
TCP/IP stack for KC-1300 V1.xx  
[0] Print this menu  
[1] IP Menu  
[2] SNMP Menu  
[3] View System status  
[4] View Converter Slots Status  
[5] Restore Default Value  
[6] Security Manager  
[7] Update Firmware  
[8] Reboot System  
[9] Exit  
Please Select (0-9 )....  
Enter Esc to abort....  
INET>  
-----
```

After prompt, type a number followed by [Enter] key for selecting an operation item to perform. See example below:

```
INET> n <Enter>
```

Select [0] to display main menu again. [Esc] key can be used to abort the operation of any item and back to main menu.

The following sections describe the detailed operation of each item.

## 4.1 IP Menu

Select [1] from Setup menu to set IP related settings.

-----  
IP Menu

[0] Print this menu

[1] Set IP Address

[2] View IP Status

[3] Exit

Please Select (0-3)  
-----

### Set IP Address

-----  
Enter ESC to abort.

Please Input IP Address (xxx.xxx.xxx.xxx) : 192.168.0.23

replacing net[0] IP address nnn.nnn.nnn.nnn with 192.168.0.23

Please Input Subnet Mask (xxx.xxx.xxx.xxx) : 255.255.255.0

replacing subnet mask[0] IP address nnn.nnn.nnn.nnn with 255.255.255.0

Please Input Gateway IP (xxx.xxx.xxx.xxx) : 192.168.0.1

replacing gateway IP addr[0] nnn.nnn.nnn.nnn with 192.168.0.1

Do you want to Change IP setting ? (Y/N) Y

Please reboot system and use new IP to connection it !  
-----

**IP Address:** Unique IP address designated to this system  
**Subnet Mask:** The subnet mask of the IP address specified above  
**Gateway:** The IP address of the default gateway (router)

Note that all current in-band network management connections on the system will be killed if system IP address is changed. This change does not affect the operation of the media converter modules in slots.

### View IP Status

-----  
IP Addr: 192.168.0.23 Submask: 255.255.255.0 Gateway: 192.168.0.1  
-----



## 4.2 SNMP Menu

Select [2] from Setup menu to perform SNMP related settings. The following figure illustrates the SNMP menu:

```
-----  
Snmp Menu  
[0] Print this menu  
[1] View Snmp Setting  
[2] Set Snmp Name  
[3] Set Snmp Location  
[4] Set Snmp Contact  
[5] Set Snmp Community  
[6] Set Snmp Trap Manager  
[7] Exit  
Please Select (0-7)....  
INET>  
-----
```

SNMP related settings are:

- Name:** Logic name for the system (127 characters)
- Location:** Location where the system is installed (127 characters)
- Contact:** Contact person regarding the system (127 characters)
- Community:** SNMP communities to which the system belongs and access right to the system ( R : read only, W : read/write)  
Maximum of four communities are supported.
- Trap manager:**  
IP address of the trap host to which a trap is issued and the trap community to which the system belongs.  
Maximum of three trap hosts are supported.

[Esc] key can be used to abort unfinished setting.

## 4.3 View System Status

Select [3] from Setup menu to view system status. The system status are shown as follows:

```
-----  
Power 1 Status: Good , Power 2 Status: Good  
FAN status: Good  
CPU status:  
Cpu Type = ARM7, Flash Size = 512K, Sdram Size = 2M Bytes  
Software version 1.xx  
-----
```

Power status indicates the status of system power 1&2 chassis.

**Power Status : Good, Bad**

FAN status indicates the status of system cooling fan.

**FAN Status : Good, Bad**

CPU information and software version are static information for reference.

## 4.4 View Converter Slots Status

Select [4] from setup menu to view current status of all media converter modules in the system. The slot status are shown as follows:

```
-----  
Slot Port Media Speed Duplex Link Slot Port Media Speed Duplex Link RTP  
01 A TX 100M Full Up 01 B FX 100M Full Up UP  
02 A TX 100M Full Up 02 B FX 100M Full Up UP  
03 A TX 100M Full Up 03 B FX 100M Full Up UP  
04 A TX 100M Full Up 04 B FX 100M Full Up UP  
05 A TX 100M Full Up 05 B FX 100M Full Up UP  
06 A TX 100M Full Up 06 B FX 100M Full Up N/A  
07 A TX 100M Full Up 07 B FX 100M Full Up N/A  
08 A TX 100M Full Up 08 B FX 100M Full Up N/A  
09 A TX 100M Full Up 09 B FX 100M Full Up N/A  
10 A TX 100M Full Up 10 B FX 100M Full Up N/A  
11 A TX 100M Full Up 11 B FX 100M Full Up N/A  
12 A TX 100M Full Up 12 B FX 100M Full Up -  
13 A TX 100M Full Up 13 B FX 100M Full Up -  
14 A TX 100M Full Up 14 B FX 100M Full Up -  
15 A TX 100M Full Up 15 B FX 100M Full Up -  
16 A TX 100M Full Up 16 B FX 100M Full Up -  
-----
```

The slot status definitions are:

<b>Column</b>	<b>States</b>	<b>Interpretation</b>
Slot	01-16	Slot position in the system Slot #1 - slot #16 are for MC
Port	N/A A B	No module is installed in slot Upper port of the module in slot Lower port of the module in slot
Media	N/A TX T FX X	No MC is installed in slot. 10BASE-T, 10/100BASE-TX port type 1000BASE-T port type 100BASE-FX port type 1000BASE-X port type
Speed	N/A 10M 100M 1000M	No MC is installed in slot 10Mbps 100Mbps 1000Mbps
Duplex	N/A Full Half	No MC is installed in slot. Full duplex Half duplex
Link	N/A Up Down	No MC is installed in slot. Link up Link down
RTP *	N/A Up -	Status not available Remote MC TP link up MC in slot does not support RTP

\* RTP : Remote MC TP link status monitoring is available only when both the MC in the rack and the remote link partner support the function through fiber link.

## 4.5 Restore Default Values

Select [5] from Setup menu to restore factory default settings.

Factory default settings are:

IP Address	192.168.0.2
Subnet Mask	255.255.255.0
Default Gateway	192.168.0.1
User Name	admin
Password	123
Name	(null)
Location	(null)
Contact	(null)
SNMP Communities:	
No.1 Community name	public
No.1 Access right	Read only
No.2 Community name	(null)
No.2 Access right	(N/A)
No.3 Community name	(null)
No.3 Access right	(N/A)
No.4 Community name	(null)
No.4 Access right	(N/A)
SNMP Trap Managers:	
No.1 Trap manager IP	(null)
No.1 Community name	(null)
No.2 Trap manager IP	(null)
No.2 Community name	(null)
No.3 Trap manager IP	(null)
No.3 Community name	(null)

## 4.6 Security Manager

Select [6] from Setup menu to change login user name and password.

The steps are:

### Display current user name

```
-----  
Current username: admin  
Current password: *****
```

```
Press Esc to abort ....  
-----
```

### Change user name and password

```
-----  
Change username [admin]: xxxxxx  
Enter password(1-8): *****  
Confirm password: *****  
Password updating .....  
Password updated.  
INET>  
-----
```

## 4.7 Update Firmware

Select [7] from Setup menu to perform firmware (system software) upgrade via TFTP protocol. Before doing TFTP operation, one TFTP server is required and installed in the network to where this system connects and new firmware file **image.bin** must be placed in the TFTP server.

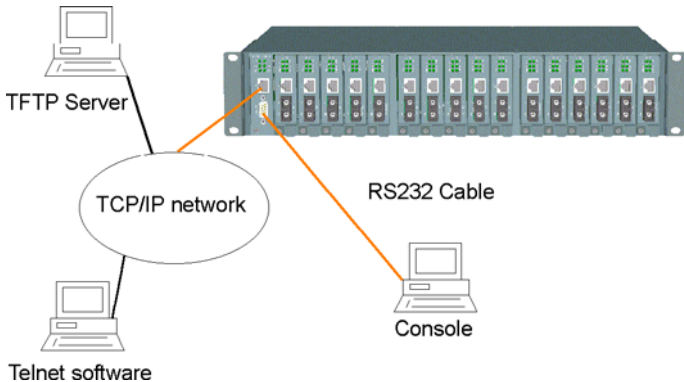

The following information are required for TFTP operations:

**TFTP Server IP Address:** IP address of the TFTP server where the firmware image.bin is downloaded from.

The steps are:

### **Specify TFTP server IP address**

```
-----  
Enter ESC to abort.  
Please Input TFTP Server IP Address (xxxx.xxx.xxx.xxx):192.168.0.88  
TFTP Server: 192.168.0.88  
-----
```

### **Confirm to start downloading**

```
-----  
Do you want to start download new image ? (Y/N) Y  
Download image and please wait.....  
-----
```

### **Confirm to update system flash memory**

```
-----  
Download new image complete, do you want to update flash ? (Y/N) Y  
Update flash and please wait ....  
Update flash complete and please reboot system !  
INET>  
-----
```

## **4.8 Reboot System**

Select [8] from Setup menu to reboot the system. This reboot function allows you to perform a warm start to the system.

```
-----  
Do you want to reboot system ? (Y/N) Y  
-----
```



## 5. SNMP Management

---

SNMP management are performed at a network management station running SNMP network management application manager software with graphical user interface. The following figure illustrates an example model:

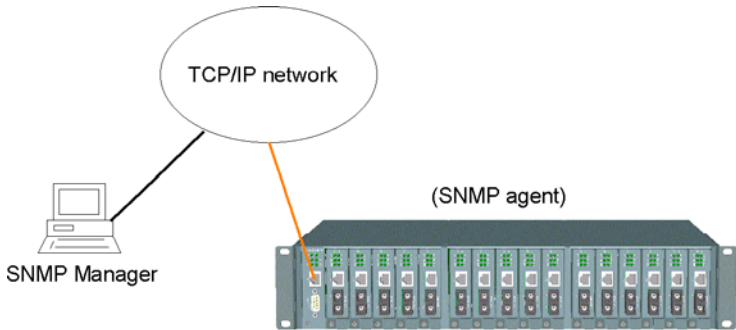

The system unit serves as an SNMP agent and provides the capabilities that allows network administrators via SNMP protocol to set parameters and view system status and media converter status defined in the standard MIB-II and private MIB.

## 5.1 Configuring SNMP Settings via Console Operation

Before performing SNMP operation, proper SNMP settings must be configured in the system unit. The SNMP related settings are:

- Name:** Logic name to identify a specific system unit
- Location:** Location where the system is installed
- Contact:** Contact person regarding the system
- Community:** SNMP communities to which the system belongs  
and access right to the system ( read only or read/write)
- Trap hosts:** IP addresses of trap hosts to which a trap is issued  
and the trap community to which the system belongs.

Up to four SNMP communities and up to three trap hosts are supported by the system SNMP agent.

These settings can be configured through console or telnet operation. Refer to Chapter 4 for more information.

## 5.2 SNMP Private MIB

Use the SNMP management application software to compile the MIB file first before performing any management operation. In addition to standard MIB-II (RFC1213), the system supports private MIB as below:

<b>Private MIB Objects</b>	<b>Get</b>	<b>Remark</b>
ssPowerStatus(kti.30.1.1)	Y	Power 1&2 status
ssFanStatus(kti.30.1.2)	Y	System fan status
cputype(kti.30.2.1)	Y	ARM7
flashrom(kti.30.2.2)	Y	512KB
memsize(kti.30.2.3)	Y	2MB
softwarever(kti.30.2.4)	Y	1.xx
mibFileVer(kti.30.2.5)	Y	1.xx
portNumber(kti.30.3.1)	Y	Total number of slots
portTable(kti.30.3.2)	-	
portEntry(1)	-	
slotIndex(1)	Y	Slot ID 1 - 16
slotIndexDescription(2)	Y	Slot1 - Slot16
slotModuleDescription(3)	Y	
slotModuleType(4)	Y	
sotModuleStatus_PortA_Media(5)	Y	Port A media type
slotModuleStatus_PortA_LineSpeed(6)	Y	Port A line Speed
slotModuleStatus_PortA_Duplex(7)	Y	Port A duplex mode
slotModuleStatus_PortA_LinkStatus(8)	Y	Port A Link status
slotModuleStatus_PortB_Media(9)	Y	Port B media type
slotModuleStatus_PortB_LineSpeed(10)	Y	Port B line speed
slotModuleStatus_PortB_Duplex(11)	Y	Port B duplex mode
slotModuleStatus_PortB_LinkStatus(12)	Y	Port B link status
slotModuleStatus_RTP_LinkStatus(13) *	Y	Remote MC link status

Note: Port A : the upper port of the MC, Port B : the lower port of the MC

Refer to MIB file, KC1300-Vx.xx.mib for the details. This file can be used for MIB compiler.

## 5.3 SNMP Traps

The system also supports the following SNMP traps. When the trap event occurs, the SNMP agent will generate a trap notification to SNMP management station.

<b>Trap Name</b>	<b>Event of Trap Generated</b>
Cold Start	The system is powered on and complete initialization
Authentication failure	SNMP community authentication failure
Power status	Any power failure of Power1 and Power2
Power status	Any power recovery of Power1 and Power2
Fan status	Fan failure
Fan status	Fan recovery
Slot # Port A link	Slot # MC Port A link down or up
Slot # Port A link	Slot # MC Port A link recovery
Slot # Port B link	Slot # MC Port B link down or up
Slot # Port B link	Slot # MC Port B link recovery
Slot # RTP link	Slot # remote MC TP link change

The binding information together with a trap is :

<b>Trap Name</b>	<b>VarBind</b>
Cold Start	sysDescr, ie KC-1300
Authentication failure	sysDescr, ie, KC-1300
Power Status	Power status for Power1 and Power2
Fan Status	Fan status
Slot # Port A link	Slot description and Port A link status
Slot # Port B link	Slot description and Port B link status
Slot # RTP link	Slot description and remote MC TP link status

Remark:

1. The slot # can be slot 1 up to slot 16.
2. Port A : the upper port of the MC installed in slot.
3. Port B : the lower port of the MC installed in slot.

## 6. Web Management

---

The system features an http server which can serve the management requests coming from any web browser software over internet or intranet network.

### **Web Browser**

Compatible web browser software with JAVA support

Microsoft Internet Explorer 4.0 or later

Netscape Communicator 4.x or later

### **Set IP Address for the System Unit**

Before the system can be managed from a web browser software, make sure a unique IP address is configured to the system. Refer to Chapter 4 for how to set IP address.

## **6.1 Start Browser Software and Making Connection**

Start your browser software and enter the IP address of the system unit to which you want to connect. The IP address is used as URL for the browser software to search the device.

URL : `http://xxx.xxx.xxx.xxx/`

Factory default IP address : 192.168.0.2

## 6.2 Login to the System Unit

When browser software connects to the system unit successfully, a Login screen is provided for you to login to the device as follows:



Enter Network Password

Please type your user name and password.

Site: 192.168.0.27

Realm: index.htm

User Name

Password

Save this password in your password list

OK Cancel

### Login

Username : Admin

Factory default Password : 123

The following screen shows welcome screen when a successful login is performed.

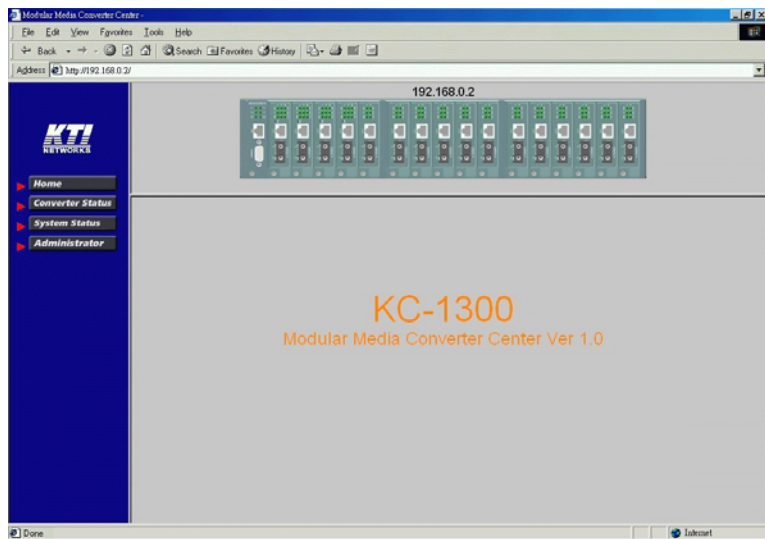

In addition to the device image, the screen supports the following functions on the right side:

1. Home : home page and device image
2. Converter Status : view all slot status
3. System Status : view system related status
4. Administrator : other management functions

## 6.3 Converter Status

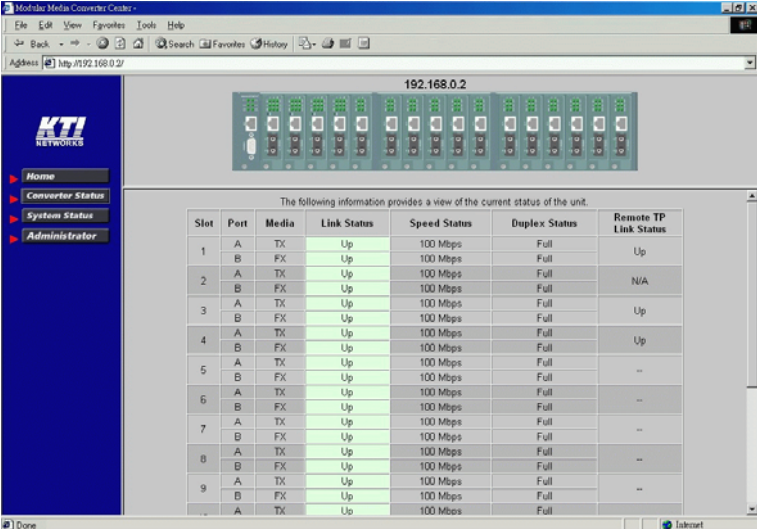

The following information provides a view of the current status of the unit.

Slot	Port	Media	Link Status	Speed Status	Duplex Status	Remote TP Link Status
1	A	TX	Up	100 Mbps	Full	Up
	B	FX	Up	100 Mbps	Full	
2	A	TX	Up	100 Mbps	Full	N/A
	B	FX	Up	100 Mbps	Full	
3	A	TX	Up	100 Mbps	Full	Up
	B	FX	Up	100 Mbps	Full	
4	A	TX	Up	100 Mbps	Full	Up
	B	FX	Up	100 Mbps	Full	
5	A	TX	Up	100 Mbps	Full	--
	B	FX	Up	100 Mbps	Full	
6	A	TX	Up	100 Mbps	Full	--
	B	FX	Up	100 Mbps	Full	
7	A	TX	Up	100 Mbps	Full	--
	B	FX	Up	100 Mbps	Full	
8	A	TX	Up	100 Mbps	Full	--
	B	FX	Up	100 Mbps	Full	
9	A	TX	Up	100 Mbps	Full	--
	B	FX	Up	100 Mbps	Full	
..	A	TX	Up	100 Mbps	Full	

Click [**Converter Status**] to view all slot status in a table list.



The information includes:

<b>Column</b>	<b>States</b>	<b>Interpretation</b>
Slot	1-16	Slot position in the system Slot #1 - slot #16 are for MC installation
Port	A B	Upper port of the MC in slot Lower port of the MC in slot
Media	TX T FX X	10/100BASE-TX copper port type 1000BASE-T copper port type 100BASE-FX Optic fiber port type 1000BASE-X Optic fiber port type
Link	Green Red	Link up Link down
Speed	10Mbps 100Mbps 1000Mbps	10BASE-T 100BASE-TX or 100BASE-FX 1000BASE-T or 1000BASE-SX/LX
Duplex	Full Half	Full duplex Half duplex
RTP link	Green Red	Remote MC TP link up Remote MC TP link status not available

## 6.4 System Status

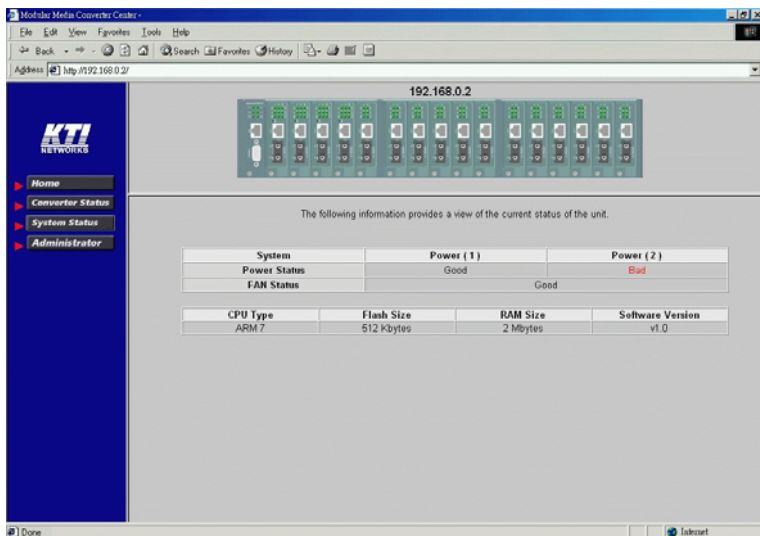

The screenshot shows a web browser window displaying the KTI Networks Management Center. The address bar shows the URL `http://192.168.0.2/`. The page title is "192.168.0.2". The interface includes a navigation menu on the left with options: Home, Converter Status, System Status, and Administrator. The main content area displays a status overview for the unit, including a table of system and power status, and a table of hardware specifications.

System	Power ( 1 )	Power ( 2 )
Power Status	Good	Bad
FAN Status	Good	

  

CPU Type	Flash Size	RAM Size	Software Version
ARM 7	512 Kbytes	2 Mbytes	v1.0

Click [**System Status**] to view system related status in a table list. The information includes:

- Power Status:** system power 1&2 chassis condition
- FAN Status:** system fan status
- CPU type:** CPU model equipped in management module
- RAM size:** Memory size equipped in management module
- Flash size:** Flash memory equipped in management module
- Software version:** Software version built in management module

## 6.5 Administrator Menu

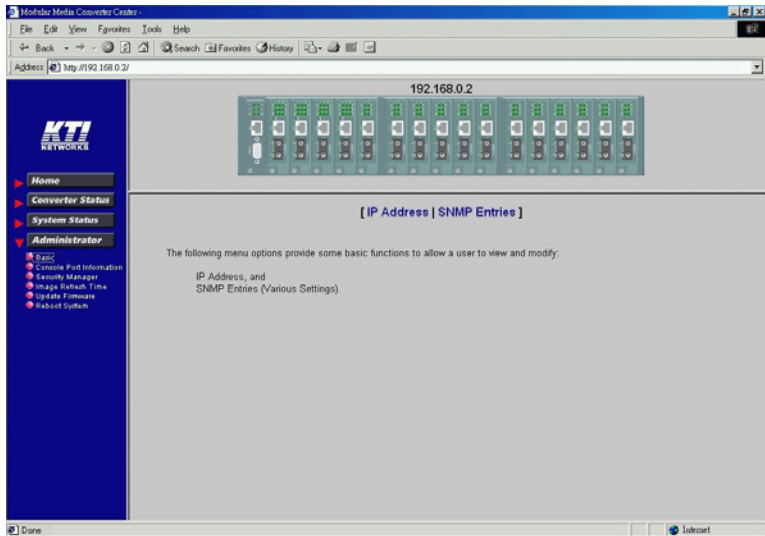

Click [**Administrator**] to show administrator menu. The menu includes the following options:

1. Basic : Set / View IP and SNMP related settings
2. Console Port Information : View RS-232 console configuration
3. Security Manager : Change login user name and password
4. Image Refresh Time : Set refresh time interval of the image
5. Update Firmware : Update the software built in SNMP module
6. Reboot System : Reboot the system remotely

Refer to the following sections for the details.

## 6.5.1 Basic

Click [Basic] to perform IP setting and SNMP settings.

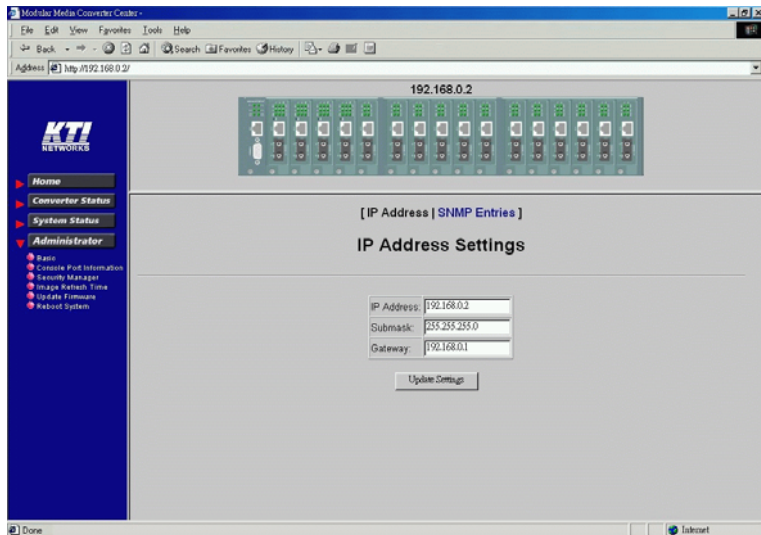

IP setting and SNMP setting are described in the following sections respectively.

Click [**IP Address**] button to set IP settings.

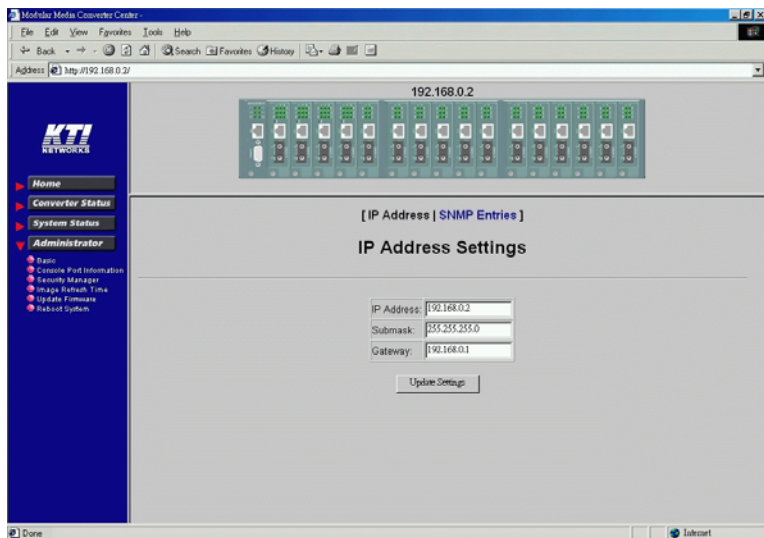

IP settings include:

- IP Address:** Unique IP address designated to this system
- Subnet Mask:** The subnet mask of the IP address specified above
- Gateway:** The IP address of the default gateway (router)

Click [**Update Settings**] to make new settings effective. However, a new IP address change will make your current connection invalid. Restart your web link with new IP address to connect the system.

Click [**SNMP Entries**] button to set SNMP settings.

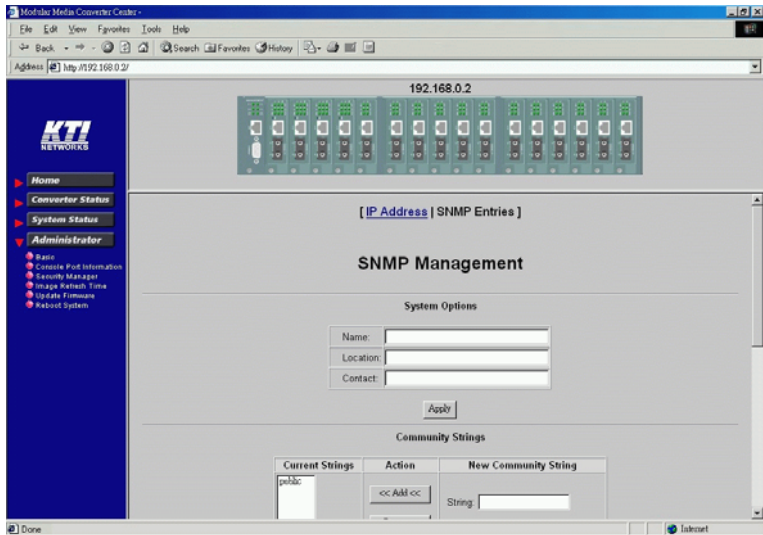

## SNMP Entries - System options

SNMP related settings are:

- Name:** Logic name for the system
- Location:** Location where the system is installed
- Contact:** Contact person regarding the system
- [Apply]:** Click button to make the settings effective

## SNMP Entries - Community Strings

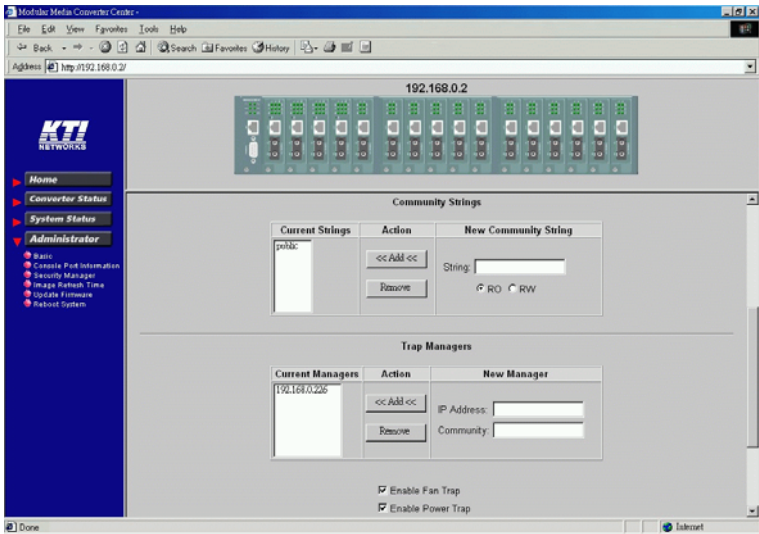

One community contains two settings:

**Community name:** SNMP communities to which the system belongs

**Access right:** Access right associated with the community name

Click [**A**dd] button to add one new community into the community list.

Click [**R**emove] button to remove one community from the community list.

Up to four entries are supported in the community list.

## SNMP Entries - Trap Managers

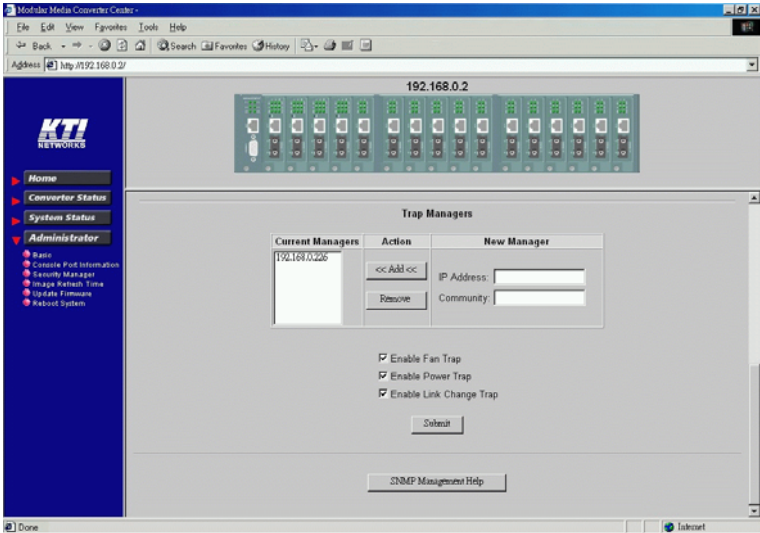

One Trap Manager contains two settings:

**IP Address:** IP address of the trap host to which a trap is issued

**Community:** The trap community to which the system belongs

**Enable Fan Trap:** Enable trap for Fan failure events

**Enable Power Trap:** Enable trap for power failure events

**Enable Link Change Trap:** Enable trap for any link change events

Click [**Add**] to add one trap manager into the manager list.

Click [**Remove**] to remove one trap manager from the manager list.



## 6.5.2 Console Port Information

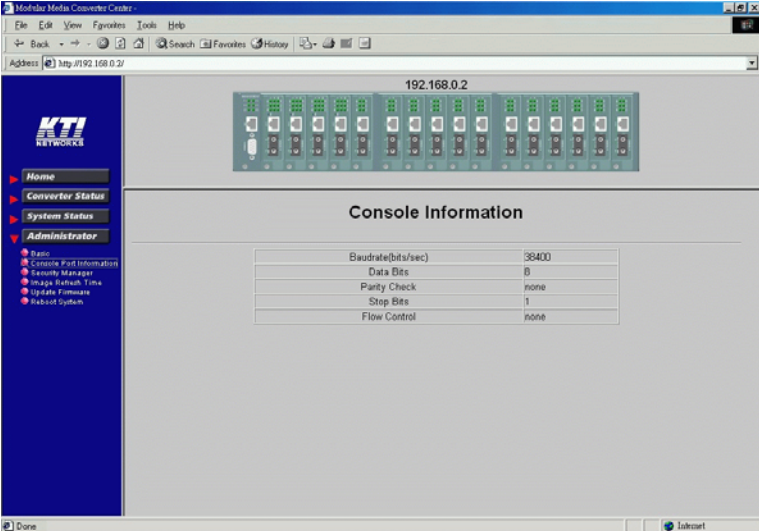

The screenshot shows a web browser window displaying the KTI Networks Converter Center interface. The browser's address bar shows the URL `http://192.168.0.2/`. The page title is "192.168.0.2". The interface features a blue sidebar on the left with the KTI Networks logo and a navigation menu with the following items: Home, Converter Status, System Status, Administrator, Base, Console Port Information, Security Manager, Manage Network Times, Upgrade Firmware, and Reboot System. The main content area displays a grid of 16 converter status icons at the top. Below this, the "Console Information" section is highlighted, containing a table with the following configuration details:

Baudrate(bits/sec)	38400
Data Bits	8
Parity Check	none
Stop Bits	1
Flow Control	none

This screen displays configuration of RS-232 console port.

## 6.5.3 Security Manager

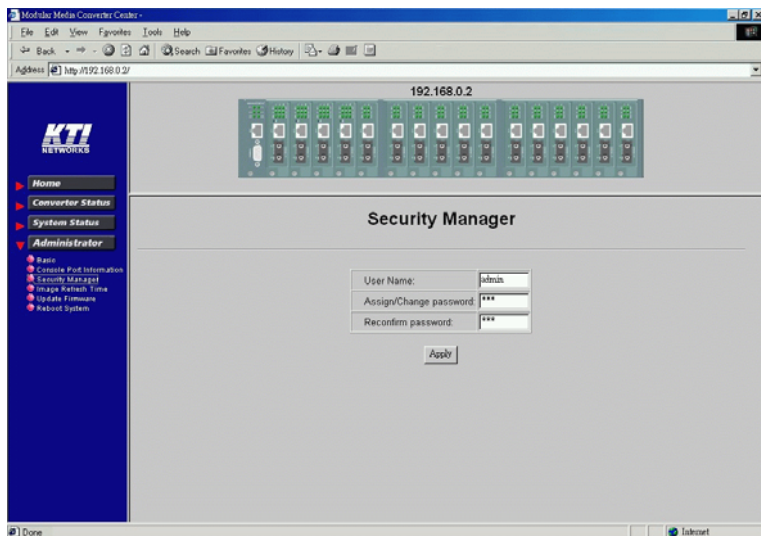

Security Manager allows you to change login user name and password. Click [**Apply**] to make the changes effective.

## 6.5.4 Image Refresh Time

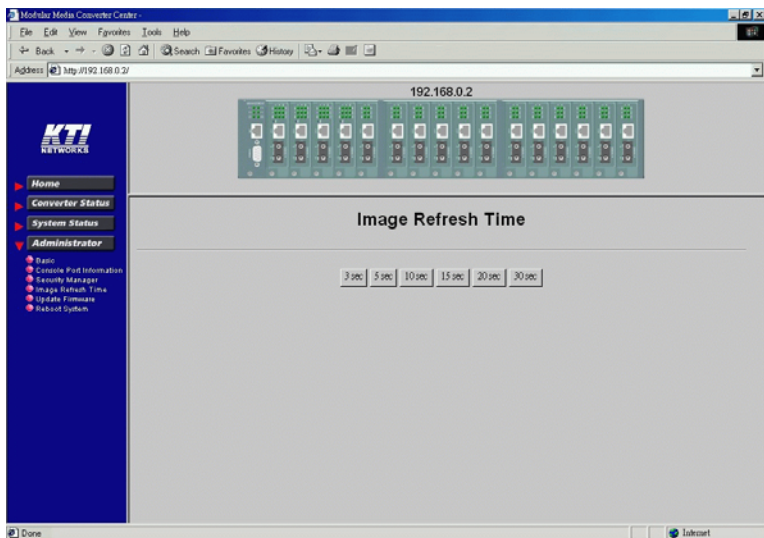

The system image is updated periodically to present the latest status. The default time interval of refreshing the image is 20 seconds. It can be changed by clicking any of the time buttons displayed. This is a run time setting and not a permanent setting.

## 6.5.5 Update Firmware

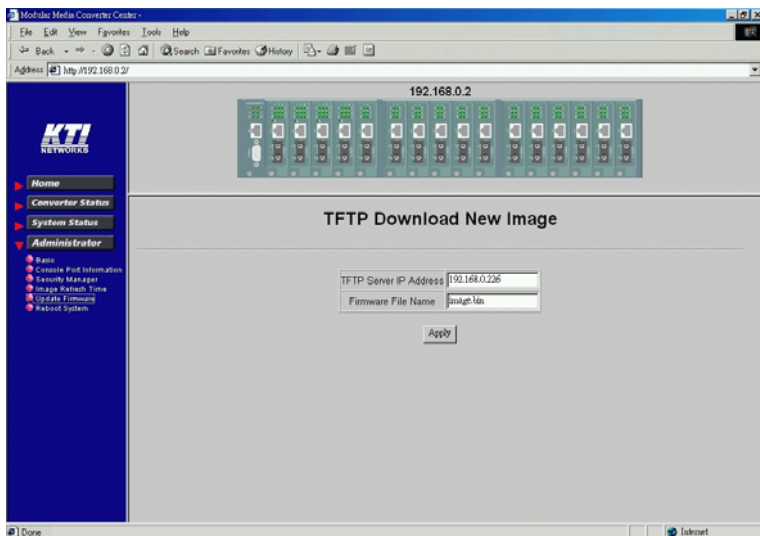

[**Update Firmware**] allows you to perform firmware (system software) upgrade via TFTP protocol. Before doing TFTP operation, one TFTP server is required and installed in the network to where this system connects and new firmware file **image.bin** must be placed in the TFTP server.

Set IP address for the TFTP server from where the firmware image is to be downloaded. Specify the file name as Image.bin.

Click [**Apply**] to start the file transfer operation.

## 6.5.6 Reboot System

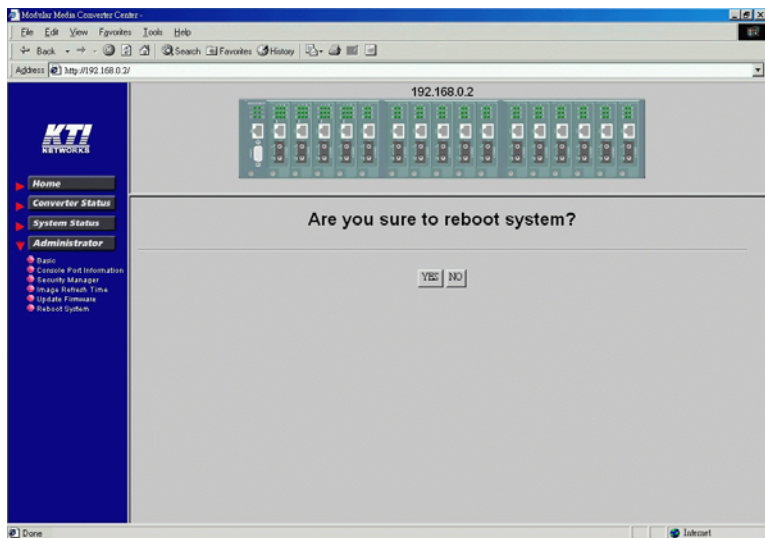

[**Reboot System**] allows you to reboot the system unit remotely. Starting this command will make your current http connection lost. You must re-build the connection to perform any management operation to the unit.

## 6.6 Slot Icon Operations

In addition to the menu supported, you may click the following image icons to show specific status.

Click slot 0 on the system image shown on screen

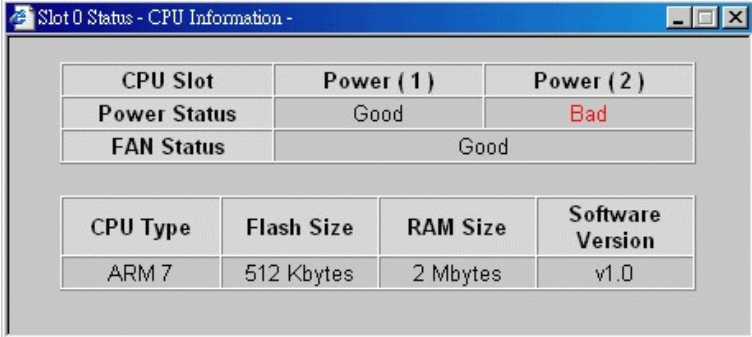

The screenshot shows a window titled "Slot 0 Status - CPU Information -" with a blue title bar and standard window controls. The main content area contains two tables. The first table shows power and fan status, and the second table shows hardware specifications.

CPU Slot	Power ( 1 )	Power ( 2 )
Power Status	Good	Bad
FAN Status	Good	

CPU Type	Flash Size	RAM Size	Software Version
ARM 7	512 Kbytes	2 Mbytes	v1.0

- Power Status:** system power 1&2 condition  
**Fan Status:** system fan status  
**CPU type:** CPU model equipped in management module  
**RAM size:** Memory size equipped in management module  
**Flash size:** Flash memory equipped in management module  
**Software version:** Software version built in management module

Click any one slot in slot 1 to slot 16 to view one specific slot status.  
The following figure illustrates slot 9 status:

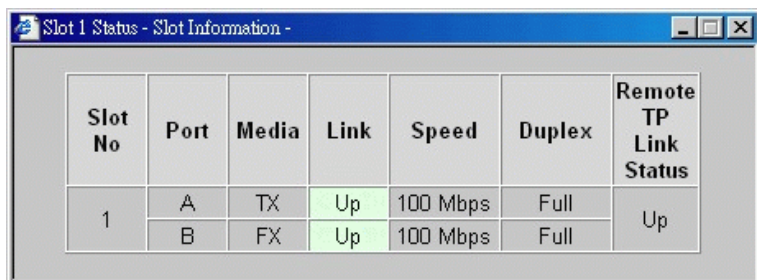

The screenshot shows a window titled "Slot 1 Status - Slot Information" with a table containing the following data:

Slot No	Port	Media	Link	Speed	Duplex	Remote TP Link Status
1	A	TX	Up	100 Mbps	Full	Up
	B	FX	Up	100 Mbps	Full	

Refer to section 6.3 for status interpretation.