

## Installation Guide 100BASE-TX/100BASE-FX Fast Ethernet Media Converter

KC-200TF SERIES

DOC. 000830-KC200TF-K Rev.1.0  
P/N: 750-0146-001

### General Description

The KC-200TF Fast Ethernet media converter series are designed to convert a 100BASE-TX signal to a 100BASE-FX signal. It is used to extend the connection distance between two Fast Ethernet Twisted-pair devices via fiber cable transparently with no performance degradation. The converter series provide different types of fiber connectors such as ST, SC, MT-RJ, and VF-45 for MM (multimode) or SM (single mode) fiber cables.

The outline of the converter is:

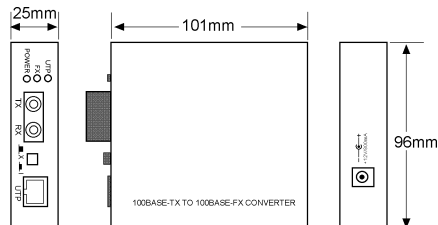

### Specifications

- Comply with IEEE 802.3u 100BASE-TX and 100BASE-FX std.
- Support connections to auto-negotiation, full-duplex and half-duplex devices.
- Environment: Temperature 0 - 40°C  
Humidity 10-90% non condensing
- Dimensions: 101mm x 96mm x 25mm
- Power: +12V / 800mA minimum
- DC plug type:

### Connectors & Cables

#### 100BASE-TX RJ-45 Connectors (UTP Port)

One RJ-45 connector is provided on the converter for 100BASE-TX connection. For easy connection to any device using standard straight-through UTP cable, a push button is available to set the crossover function for the RJ-45.

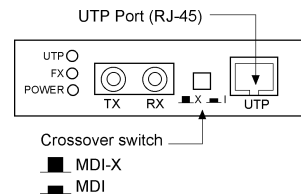

RJ-45 Pin	MDI-X Jack	MDI Jack
1	Rx+	Tx+
2	RX-	Tx-
3	Tx+	Rx+
6	Tx-	Rx-

The TP port is equipped with auto-negotiation capability which supports connection to an auto-negotiation device in full-duplex operation. This feature preserves the connection performance of the connected device.

#### 100BASE-TX UTP Cable

Cable: Category 5 UTP

Maximum cable distance: 100 meters (328 feet)

### Fiber Optic Connector (Fiber Port)

The series provides different types of fiber connectors for different applications. The connectors include ST, SC, MT-RJ and VF-45 and are shown as follows:

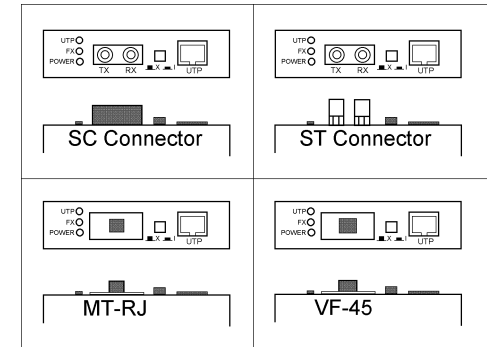

The wavelength used is 1300nm. The series also support MM (multimode) fiber cables and SM (single mode) fiber cables. The recommended MM cable is 62.5/125µm and SM cable is 9/125µm.

The following table lists the fiber connectors, fiber cables and the maximum length supported by each converter model:

Model	Connector	Cable Used	Cable Length*
KC-200TF T	ST	MM	2Km
KC-200TF C	SC	MM	2Km
KC-200TF SA	SC	SM	15Km
KC-200TF S3	SC	SM	30Km
KC-200TF S5	SC	SM	50Km
KC-200TF JM	MT-RJ	MM	2Km
KC-200TF JS	MT-RJ	SM	15Km
KC-200TF VM	VF-45	MM	2Km

\* Cable length : the maximum length in point-to-point full duplex operation

## Installation

1. Install the media converter with the DC power adapter provided. (+12VDC, 800mA)

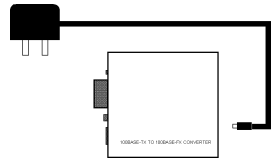

2. Connect the power adapter cable to the media converter before connecting the adapter to the AC outlet.

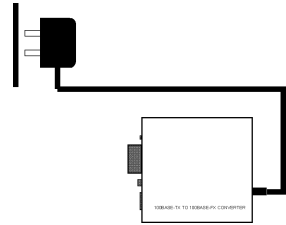

## Making Network Connections

The converters serve as a conversion path between two Fast Ethernet devices. To both devices, the conversion is transparent. The connection could be one of the following configurations:

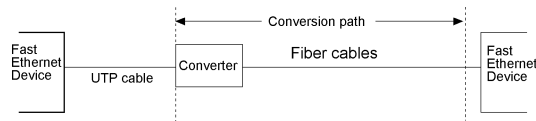
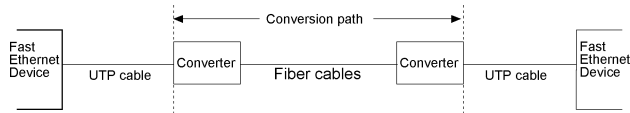

**Important rule:** When a connection is established, make sure the devices located at both ends of the path are configured and operated using the same duplex mode and the maximum distance must comply with IEEE 802.3u specifications.

The following figure illustrates a connection example between two auto-negotiation devices. Both devices operate in full-duplex mode after a negotiation process with the converters.

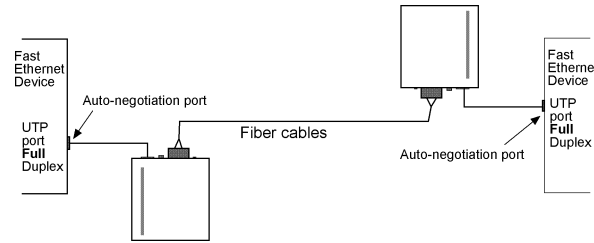

## Interpreting LED Indicators

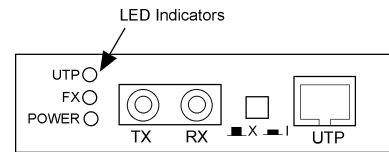

The LED labeled "UTP" is used to indicate the status of the TP port and the LED labeled "FX" is for Fiber port.

LED	Status	State	Interpretation
POWER	Power status	On	Converter is on.
		Off	Converter is off.
UTP	TP port link/Rx	On	The UTP link is ok.
		Off	No link or the link is faulty.
		Blink	Receiving on TP port
FX	Fiber port link/Rx	On	The fiber link is ok.
		Off	No link or the link is faulty.
		Blink	Receiving on Fiber port

The information contained in this document is subject to change without prior notice.

Copyright (C) KTI. All Rights Reserved.

## TRADEMARKS

Ethernet is a registered trademark of Xerox Corp.

## WARNING:

This equipment has been tested and found to comply with the limits for a Class A digital device, pursuant to Part 15 of the FCC Rules. These limits are designed to provide reasonable protection against harmful interference when the equipment is operated in a commercial environment. This equipment generates, uses, and can radiate radio frequency energy and if not installed and used in accordance with the instruction manual may cause harmful interference in which case the user will be required to correct the interference at his own expense.

## NOTICE:

(1) The changes or modifications not expressly approved by the party responsible for compliance could void the user's authority to operate the equipment.

(2) Shielded interface cables and AC power cord, if any, must be used in order to comply with the emission limits.

## CISPR A COMPLIANCE:

This device complies with EMC directive of the European Community and meets or exceeds the following technical standard.

EN 55022 - Limits and Methods of Measurement of Radio Interference Characteristics of Information Technology Equipment. This device complies with CISPR Class A.

WARNING: This is a Class A product. In a domestic environment this product may cause radio interference in which case the user may be required to take adequate measures.

## CE NOTICE

Marking by the symbol  indicates compliance of this equipment to the EMC directive of the European Community. Such marking is indicative that this equipment meets or exceeds the following technical standards:

EN 55022: Limits and Methods of Measurement of Radio Interference characteristics of Information Technology Equipment.

EN 50082/1: Generic Immunity Standard -Part 1: Domestic Commercial and Light Industry.

EN 60555-2: Disturbances in supply systems caused by household appliances and similar electrical equipment - Part 2: Harmonics.